

GRF5504

High Efficiency 3.5 Watt Power Amplifier 100 to 550 MHz

FEATURES

- Flexible Bias Voltage and Current
- 125 mA Native Mode Quiescent Current Consumption
- 5 V Supply Voltage
- -40 to 85 °C Operating Temperature Range
- Compact 3 x 3 mm QFN-16 Package
- Process: InGaP HBT

References: 5 V / 125 mA / 460 MHz

- Gain: 41 dB
- OP1dB: 34.3 dBm
- P_{SAT}: 35.3 dBm
- PAE: 61% @ P_{SAT}
- Evaluation Board Noise Figure: 4.2 dB

APPLICATIONS

- UHF
- Automatic Meter Reader
- IOT
- TETRA

 **ORDERING INFORMATION**
Buy it Now

DESCRIPTION

The GRF5504 is a high efficiency PA that delivers up to 3.5 watts at P_{SAT} with V_{CC} at 5 volts and a low I_{CCQ} of 125 mA. PAE at P_{SAT} is roughly 61%.

The device can be tuned over a range of frequencies from 100 to 550 MHz with typical fractional bandwidths of 3 to 5%.

For frequencies in the 700-1000 MHz range, GRF5509 offers slightly higher output power and higher efficiency with the same package and pinout.

Please consult with the GRF applications engineering team for custom tuning/evaluation board data.

Additional tunes can be found on the GRF5504 "Custom Tunes" product page: [GRF5504 Custom Tunes](#)

BLOCK DIAGRAM

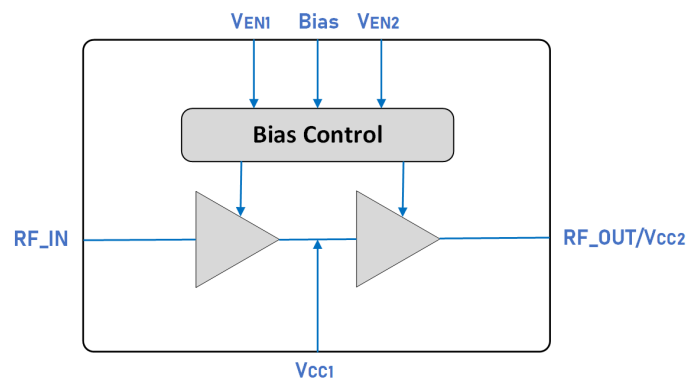

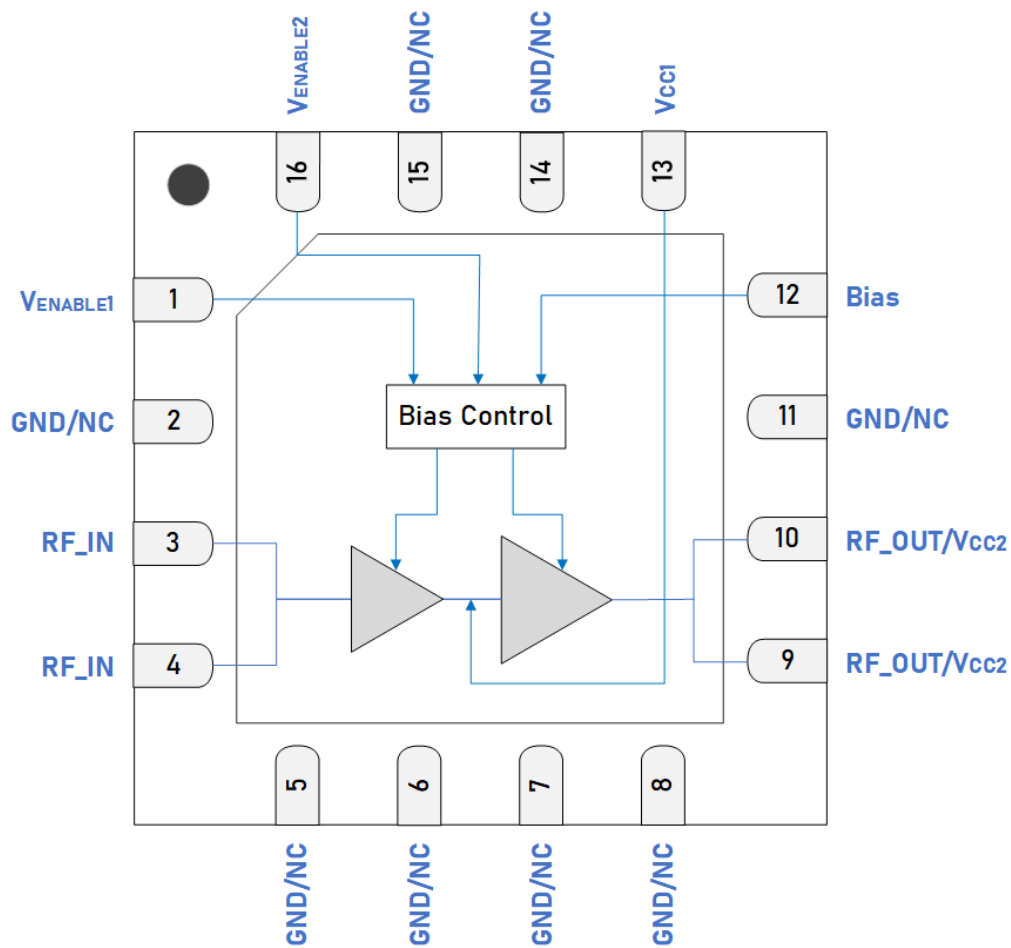

Pin Out (Top View)

Pin Assignments

Pin	Name	Description	Note
1	V _{ENABLE1}	Enable1 Voltage Input	V _{EN1} and series resistor set I _{CCQ1} for the input stage. V _{EN1} ≤ 0.2 volts disables device.
2, 5, 6, 7, 8, 11, 14, 15	GND/NC	Ground or No Connect	No internal connection to die. These pins can be left unconnected, or be connected to ground (recommended). Use a via as close to the pin as possible if grounded.
3, 4	RF_IN	RF Input	Pins 3 & 4 tied together on system board. Internally matched 50 Ω. An external DC blocking capacitor must be used.
9, 10	RF_OUT/V _{CC2}	PA Output/Bias Voltage	Pins 9 & 10 tied together on system board. V _{CC2} must be applied to this pin via a RF choke.
12	Bias	Bias Circuit Supply	Connect to V _{CC2} through external resistor.
13	V _{CC1}	Bias Voltage	Connect to V _{CC1} through external resistor.
16	V _{ENABLE2}	Enable2 Voltage Input	V _{EN2} and series resistor set I _{CCQ2} for the output stage. V _{EN2} ≤ 0.2 volts disables device.
PKG BASE	GND	Ground	Provides DC and RF ground for PA, as well as thermal heat sink. Recommend multiple 8 mil vias beneath the package for optimal RF and thermal performance. Refer to evaluation board top layer graphic on schematic page.

Truth Table

Pin	Logic State	Condition
V _{EN1}	LOW	Stage 1 Amplifier Off
	HIGH	Stage 1 Amplifier On
V _{EN2}	LOW	Stage 2 Amplifier Off
	HIGH	Stage 2 Amplifier On

Absolute Ratings

Parameter	Symbol	Min.	Max.	Unit
Supply Voltage	V_{CC}	* 2.7	5.5	V
Transient Average RF Input Power: (Load VSWR < 2:1)	$P_{IN\ MAX}$		20	dBm
Operating Temperature (Package Base)	$T_{PKG\ BASE}$	-40	85	°C
Maximum Junction Temperature (MTTF > 10 ⁶ Hours)	$T_{J\ MAX}$		170	°C
Stage 1 Maximum Dissipated Power (DC only. No RF applied)	$P_{DISS\ MAX}$		500	mW
Stage 2 Maximum Dissipated Power (DC only. No RF applied)	$P_{DISS\ MAX}$		1750	mW
Ruggedness: $V_{CC} = 5\ V$ at P_{SAT} (all phase angles)	VSWR		TBD	

* The device can be operated in saturated applications with $V_{CC} < 2.7\ V$. Please consult with the GRF applications team for details.

Electrostatic Discharge

Human Body Model	HBM	250		V
------------------	-----	-----	--	---

Storage

Storage Temperature	T_{STG}	-65	150	°C
Moisture Sensitivity Level	MSL		1	--



Caution! ESD Sensitive Device.

Exceeding Absolute Maximum Rating conditions may cause permanent damage.

Note: For additional information, please refer to [Manufacturing Note MN-001 - Packaging and Manufacturing Information](#).



All Guerrilla RF products are provided in RoHS compliant lead (Pb)-free packaging. For additional information, please refer to the [Certificate of RoHS Compliance](#).



Recommended Operating Conditions

Parameter	Symbol	Specification			Unit	Condition
		Min.	Typ.	Max.		
Supply Voltage	V_{CC}	2.7	5	5.5	V	
Operating Temperature Range	$T_{PKG\ BASE}$	-40		85	°C	
RF Frequency Range	F_{RF}	100	460	550	MHz	Typical application schematic using the 100 to 550 MHz tuning set (notes 1 & 2).
RF1 Port Impedance	Z_{RFIN}		50		Ω	Single-ended with 2 element match.
RF2 Port Impedance	Z_{RFOUT}		50		Ω	Single -ended with 2 element match.

Note 1: Operation outside of this range is supported by using different custom tunes. Examples of other optimized tunes can be found here: [GRF5504 Custom Tunes](#)

Note 2: Contact the Guerrilla RF Applications team for guidance on optimizing the tuning of the device for alternative bands.

Nominal Operating Parameters - General

Parameter	Symbol	Specification			Unit	Condition
		Min.	Typ.	Max.		
Supply Current	I_{CCQ}	90	125	160	mA	$V_{CC} = 5\text{ V}, V_{EN1} = V_{EN2} = 5\text{ V}.$
Enable Current 1	$I_{ENABLE1}$		1.0		mA	
Enable Current 2	$I_{ENABLE2}$		0.4		mA	

Disabled Mode

Supply Current (Leakage)	I_{CC}		0.03		μA	$V_{CC} = 5\text{ V}, V_{EN1} = V_{EN2} = 0\text{ V}.$
--------------------------	----------	--	------	--	---------------	--

Thermal Data

Stage 1 Thermal Resistance (Infrared Scan). DC only. No RF applied.	Θ_{JC}		140		$^{\circ}\text{C}/\text{W}$	On standard evaluation board.
Stage 2 Thermal Resistance (Infrared Scan). DC only. No RF applied.	Θ_{JC}		33		$^{\circ}\text{C}/\text{W}$	On Evaluation Board.
Therrmal Data Stage 1 and 2: see plot of Junction Temp vs. Output Power.						$V_{CC} = V_{EN1} = V_{EN2} = 5\text{ V}.$ On standard evaluation board (note 3).

Note 3: MTTF > 10^6 hours for $T_j \leq 170\text{ }^{\circ}\text{C}$



Nominal Operating Parameters - RF

The following conditions apply unless noted otherwise; typical application schematic, $V_{CC} = 5\text{ V}$, $50\ \Omega$ system impedance, $F_{TEST} = 460\text{ MHz}$, $T_{PKG\ HEAT\ SINK} = 25\text{ }^\circ\text{C}$. Evaluation board losses are included within the specifications.

Parameter	Symbol	Specification			Unit	Condition
		Min.	Typ.	Max.		
Small Signal Gain	S21		41		dB	$P_{IN} = -25\text{ dBm}$.
Evaluation Board Noise Figure	NF		4.2		dB	
Saturated Output Power	P_{SAT}	33.8	35.3		dBm	RF Input Power = 0 dBm.
Power Added Efficiency (@ P_{SAT})	PAE		61		%	RF Input Power = 0 dBm
Output 1 dB Compression Power	OP1dB		34.3		dBm	CW input.
Switching Rise Time	T_{RISE}		14		μs	@ P_{SAT}
Switching Fall Time	T_{FALL}		1		μs	@ P_{SAT}

GRF5504 Typical Operating Curves: 450 to 470 MHz Tune

GRF5504 Gain vs Frequency

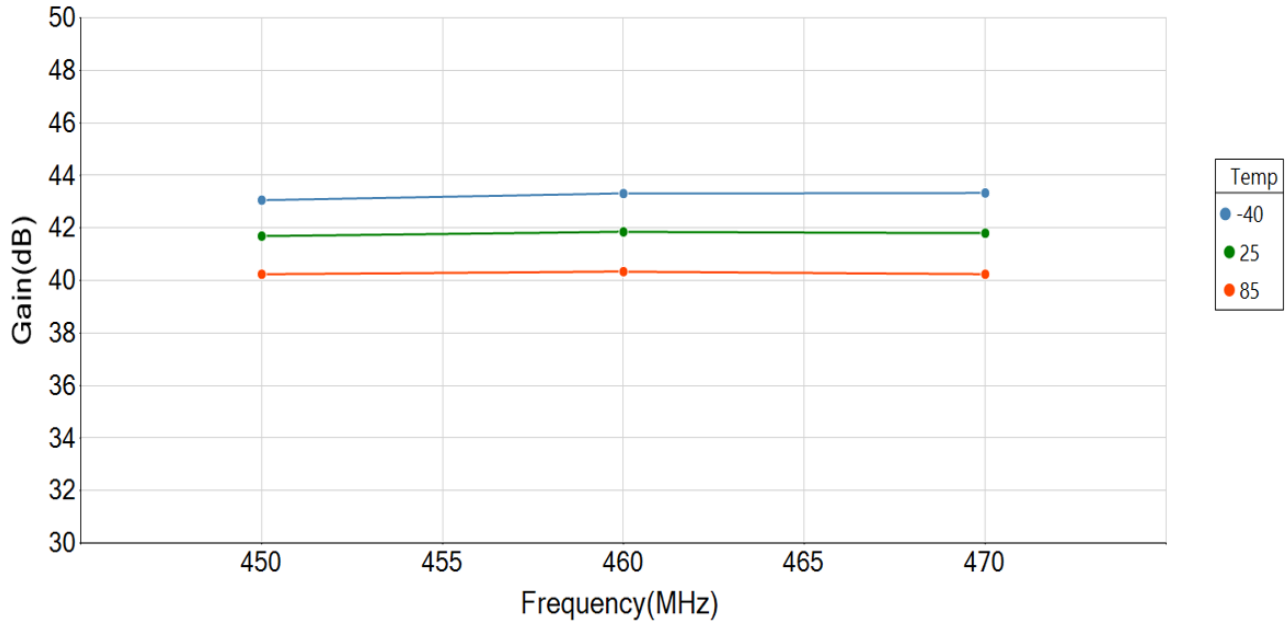

GRF5504 OP1dB vs Frequency

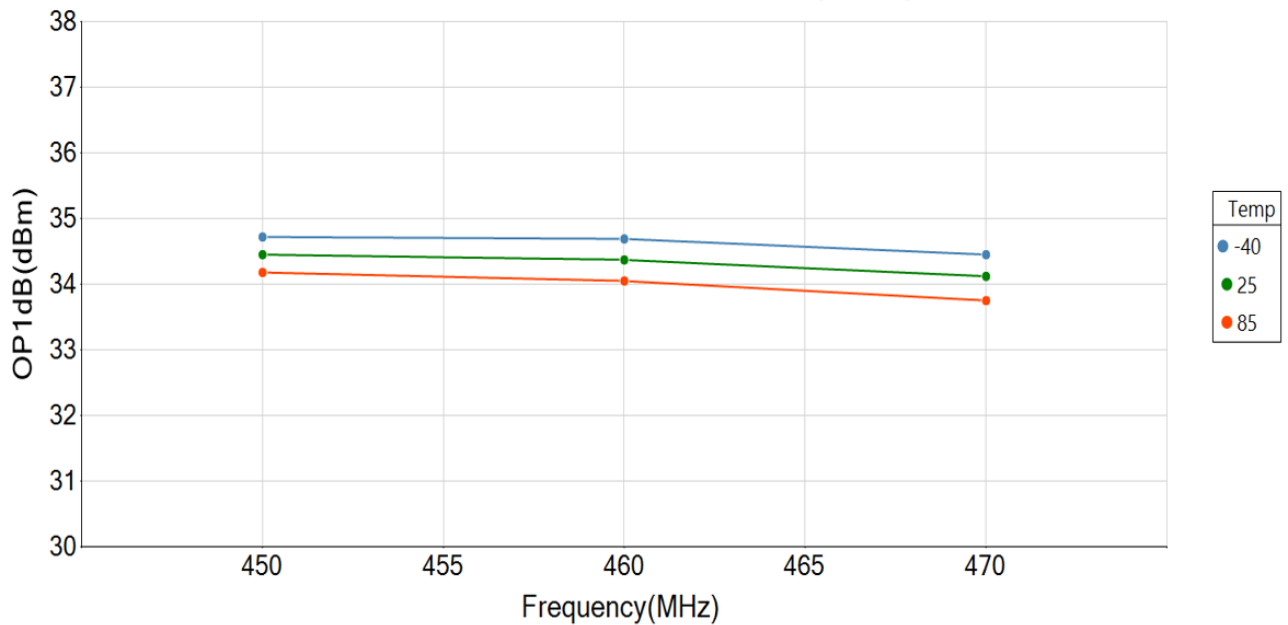

GRF5504 Typical Operating Curves: 450 to 470 MHz Tune

GRF5504 Pout vs Pin at Frequency = 460 MHz

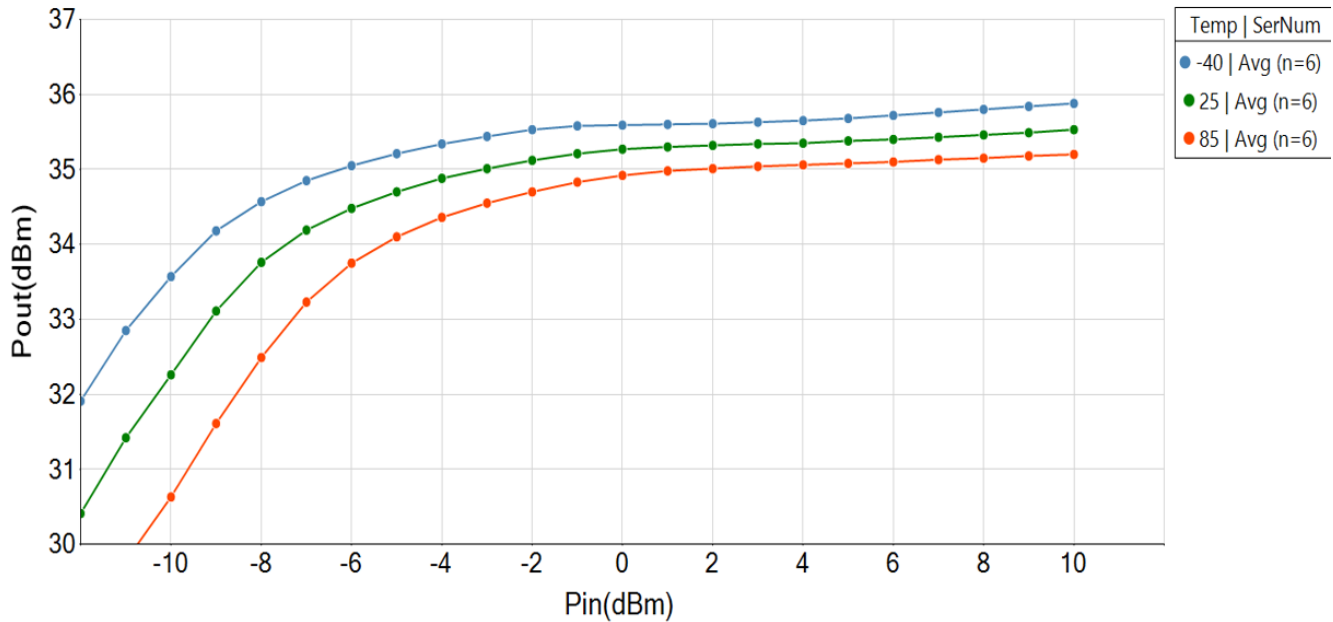

GRF5504 PAE(%) vs Pout at Frequency = 460 MHz

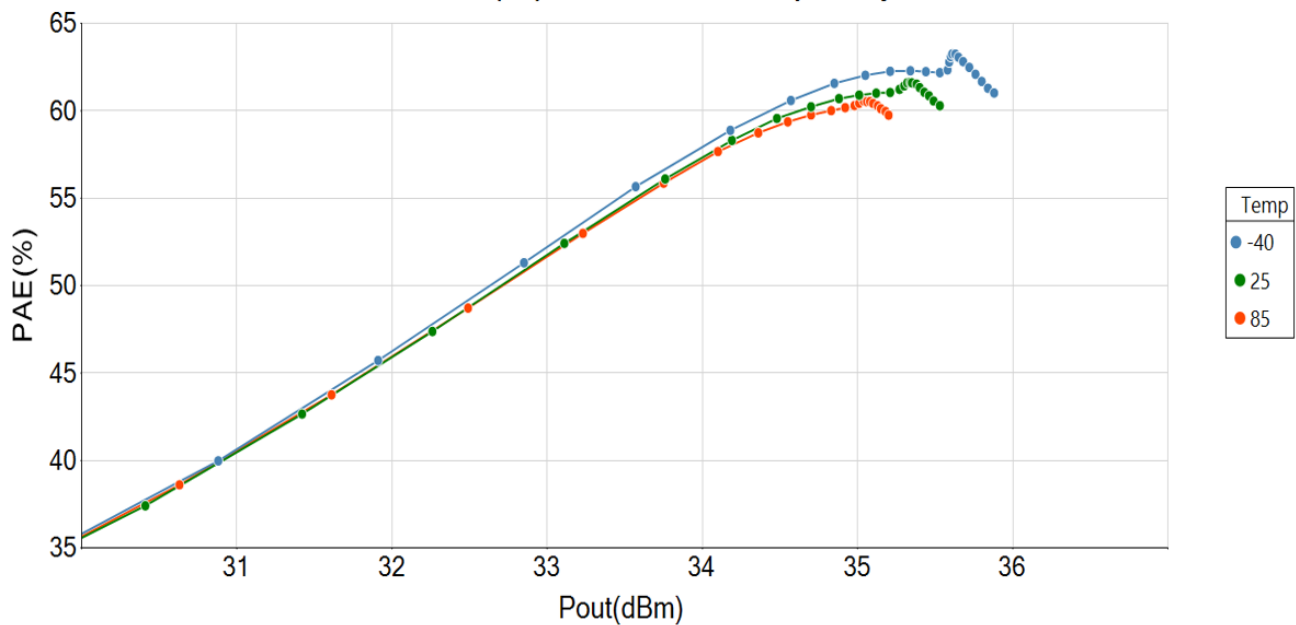

GRF5504 Typical Operating Curves: S-Parameters (450 to 470 MHz Tune)

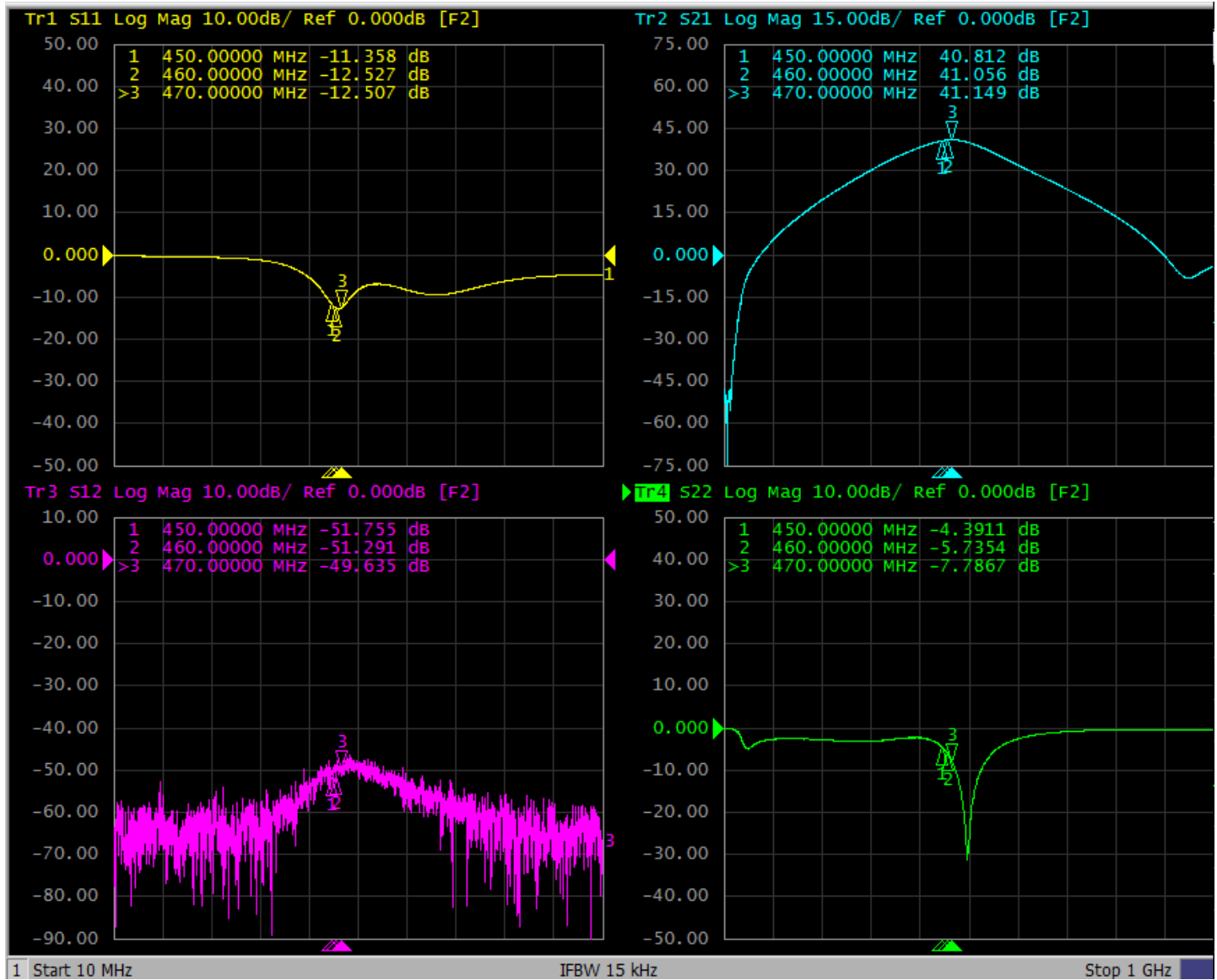

GRF5504 Typical Operating Curves: Stability Mu (10 MHz to 20 GHz)

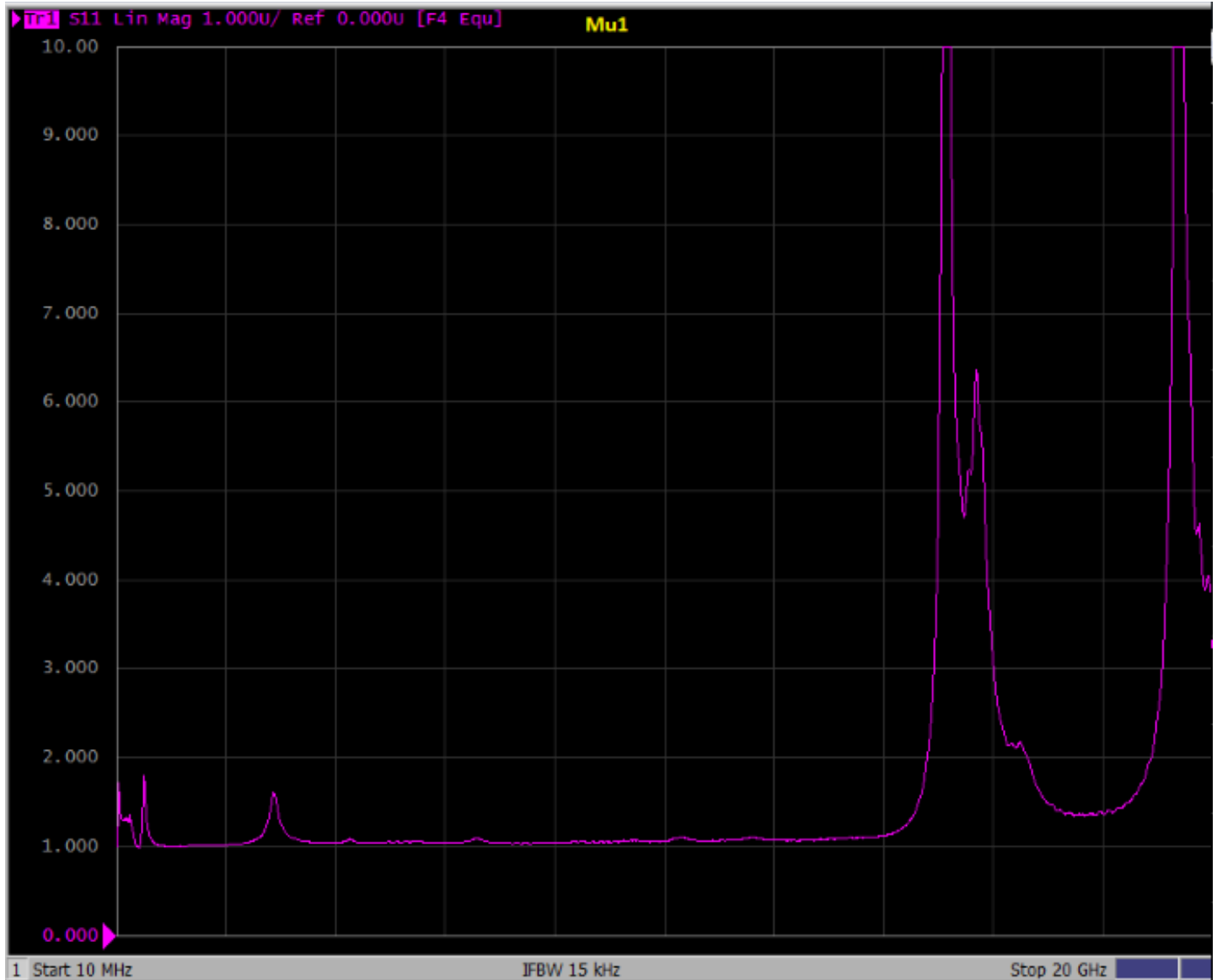

Note: Mu factor ≥ 1.0 implies unconditional stability.

GRF5504 Junction Temperature (per application schematic @ 85 °C)

GRF5504 being a 2-stage device sees one of the stages governing junction temperature over power sweep.

Red line = 20 dBm where T_J is equivalent in both stages. At left of red line, stage 1 governs T_J (Q1 T_J is higher).

To the right of red line, stage 2 governs T_J (Q2 T_J is higher).

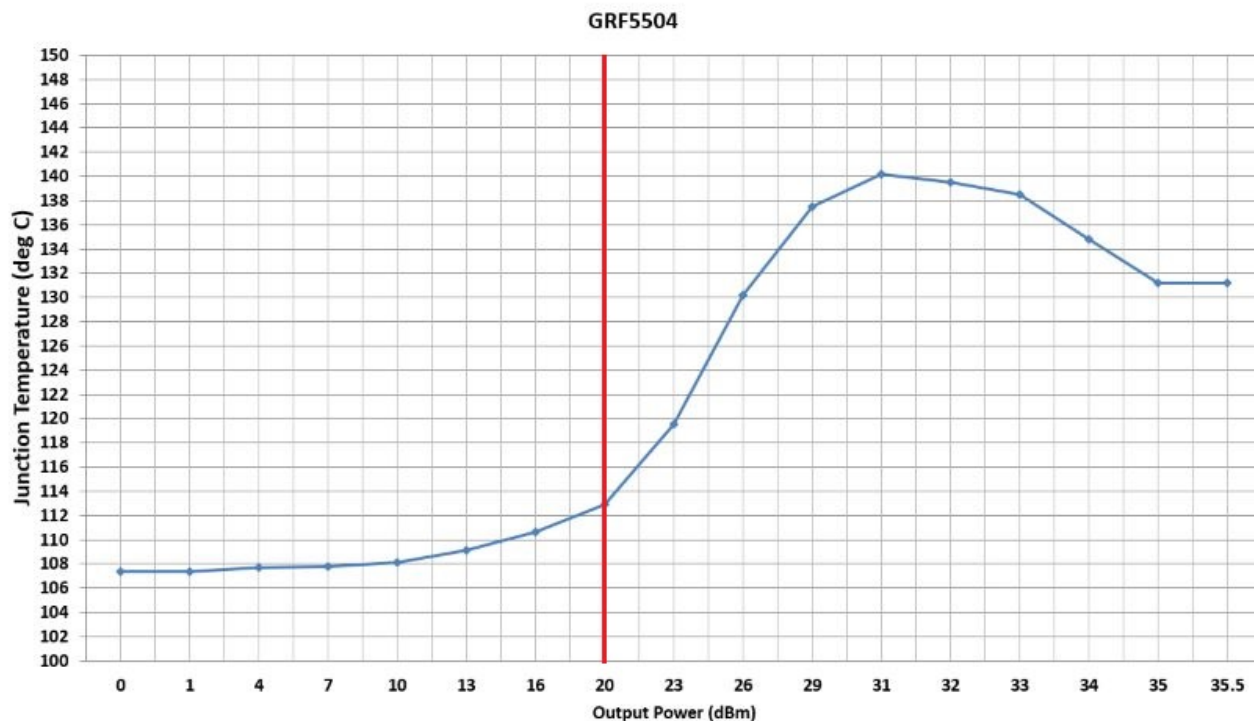

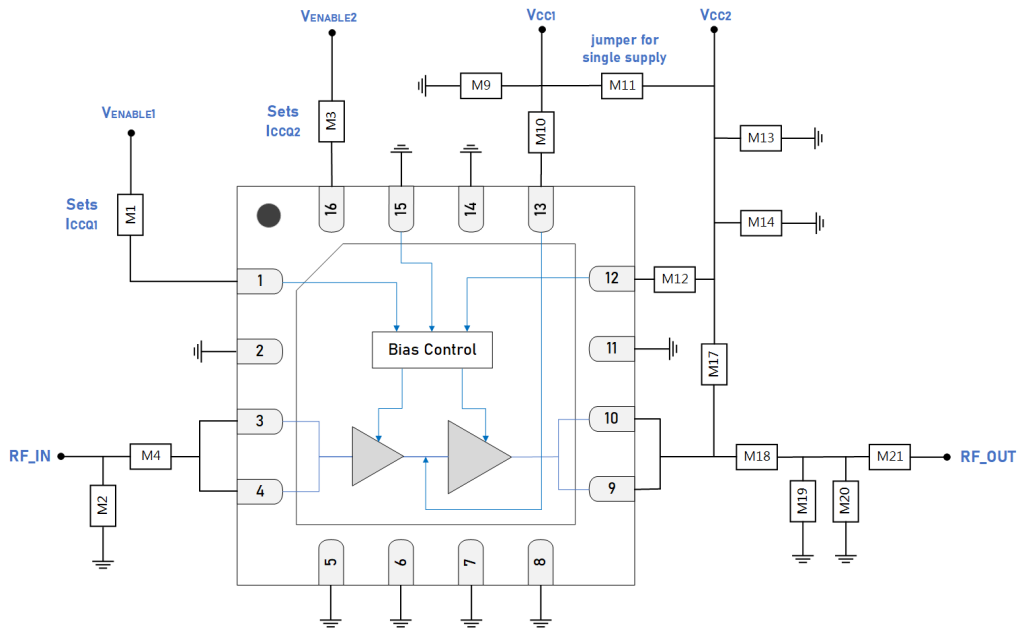

GRF5504 Standard Evaluation Board Schematic

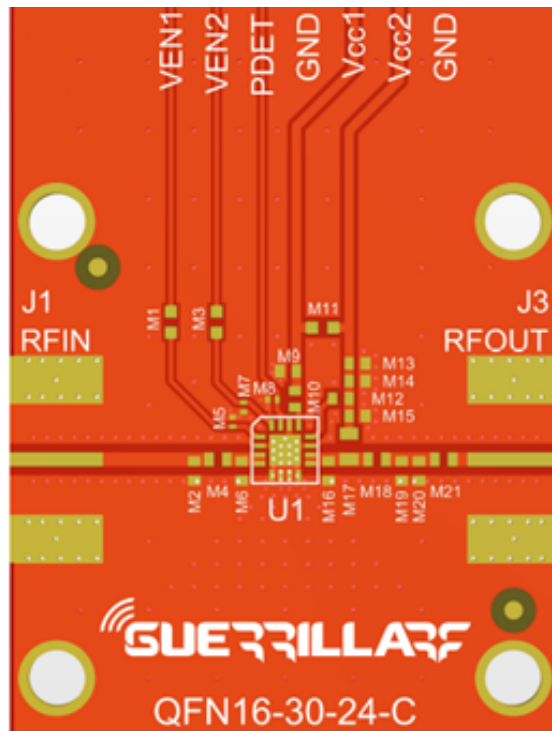

GRF5504 Evaluation Board Assembly Diagram



GRF5504 Evaluation Board Assembly Diagram Reference: 450 to 470 MHz Tune

Standard Evaluation Board Bias: $V_{CC} = V_{EN1} = V_{EN2} = 5\text{ V}$

Component	Type	Manufacturer	Family	Value	Package Size	Substitution
M1	Resistor	Various	5%	See table	0402	ok
M2	Inductor	Murata	LQG	8.2 nH	0402	ok
M3	Resistor	Various	5%	See table	0402	ok
M4	Capacitor	Murata	GJM	20.0 pF	0402	ok
M9	Capacitor	Murata	GRM	0.1 μF	0402	ok
M10	Inductor	Coilcraft	HP	5.6 nH	0402	ok
M11	Resistor (jumper)	Various	5%	0 Ω	0402	ok
M12	Resistor (jumper)	Various	5%	0 Ω	0402	ok
M13	Capacitor	Murata	GRM	0.1 μF	0402	ok
M14	Capacitor	Murata	GRM	100 pF	0402	ok
M17	Inductor	Coilcraft	0908SQ	23.0 nH	0908	ok
M18	Inductor	Coilcraft	DC	2.7 nH	0603	ok
M19	Capacitor	Murata	GJM	22.0 pF	0402	ok
M20	Capacitor	Murata	GJM	3.0 pF	0402	ok
M21	Capacitor	Murata	GRM	100 pF	0402	ok
M5, M6, M7, M8, M15, M16	DNP	--	--	--	--	--
Evaluation Board	QFN16-30-24-C					

GRF5504 Bias Resistor Selection Table: Resistors M1 and M3

V_{CC1} (V)	V_{CC2} (V)	$V_{EN1} = V_{EN2}$ (V)	I_{CCQ1} (mA)	I_{CCQ2} (mA)	Bias R M1	Bias R M3
3	3	3	20	50	1.9 k Ω	2.4 k Ω
3.5	3.5	3.5	20	55	2.7 k Ω	4.5 k Ω
4	4	4	22	65	3.3 k Ω	5.7 k Ω
4.5	4.5	4.5	25	75	3.6 k Ω	6.7 k Ω
5	5	5	30	90	3.3 k Ω	6.8 k Ω

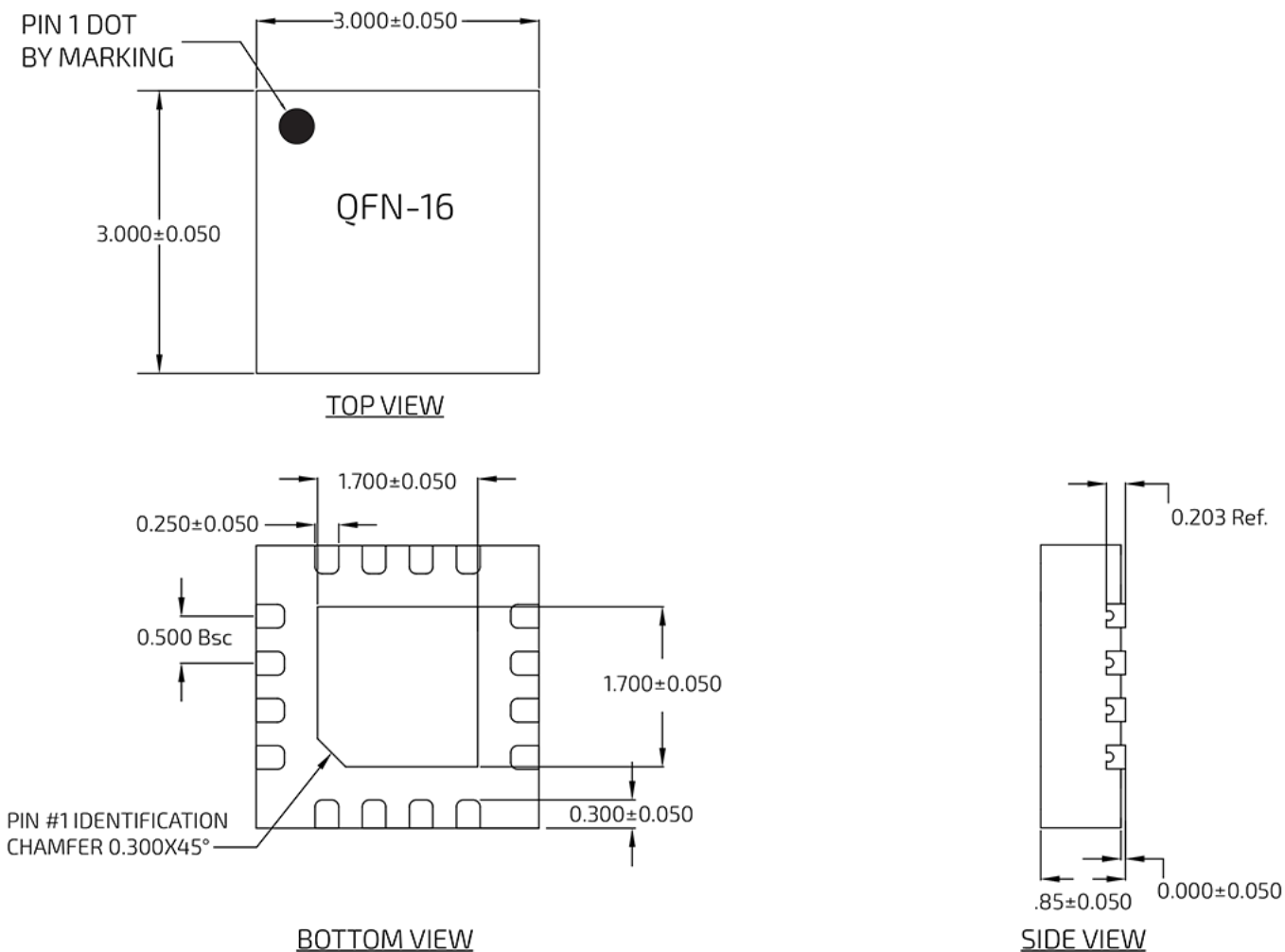

QFN 16 3x3mm Package Dimensions

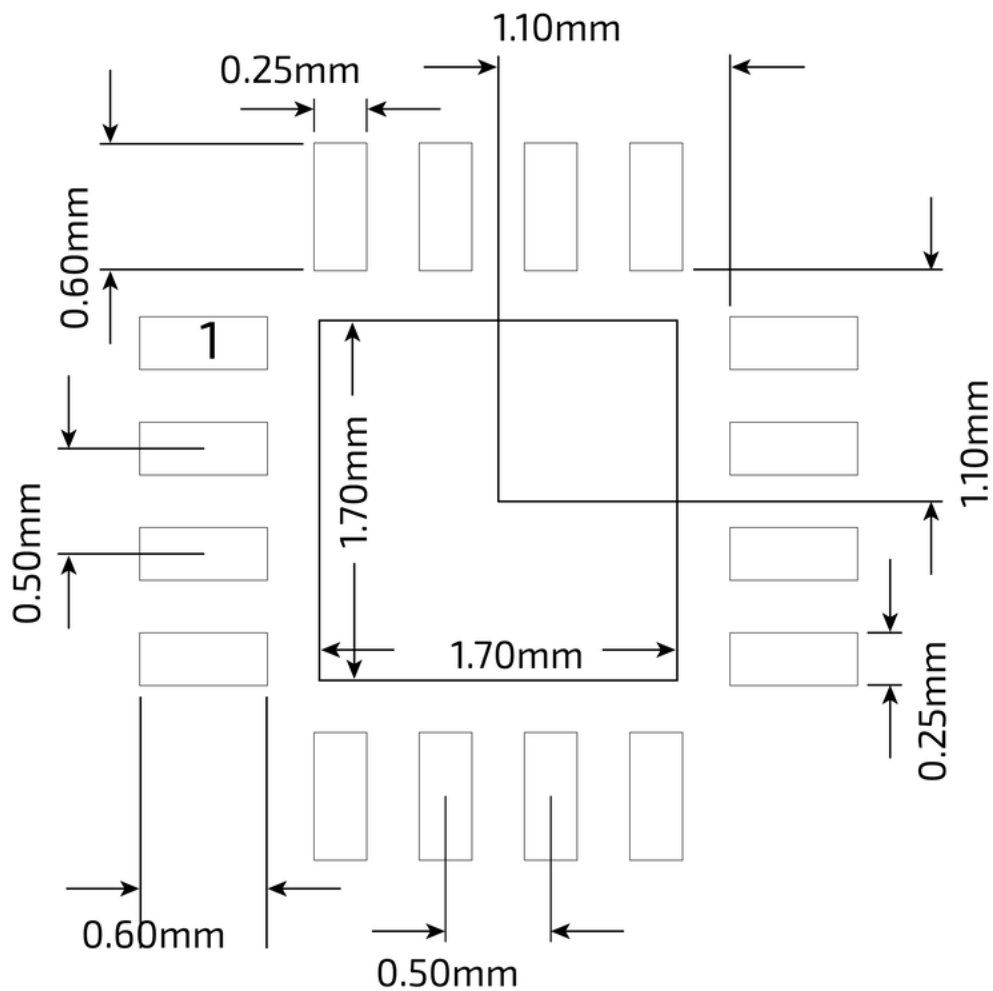

QFN 16 3x3mm Suggested PCB Footprint (Top View)

Package Marking Diagram



Line 1: "YY" = Year. "WW" = WORK WEEK the Device was assembled.
 Line 2: "GRF" = Guerrilla RF
 Line 3: "XXXX" = Device Part Number.

Tape and Reel Information

Guerrilla RF's tape and reel specification complies with Electronics Industries Association (EIA) standards for "Embossed Carrier Tape of Surface Mount Components for Automatic Handling" (reference EIA-481). Devices are loaded with pins down into the carrier pocket with protective cover tape and reeled onto a plastic reel. Each reel is packaged in a cardboard box. There are product labels on the reel, the protective ESD bag, and the outside surface of the box. For the latest reel specifications and package information (including units/reel), please visit [Package Manufacturing Information](#) | [Guerrilla RF](#) (guerrilla-rf.com).

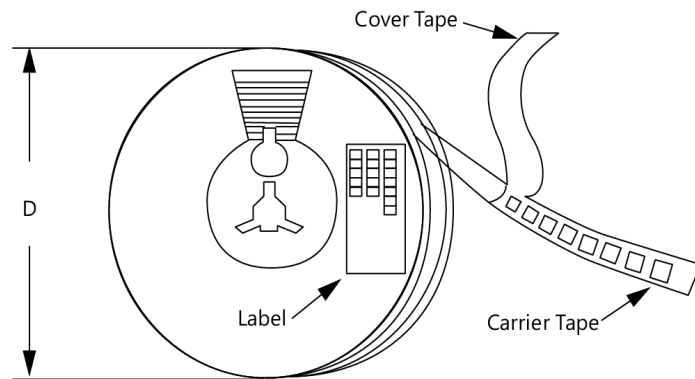

Tape and Reel Packaging with Reel Diameter Noted (D)

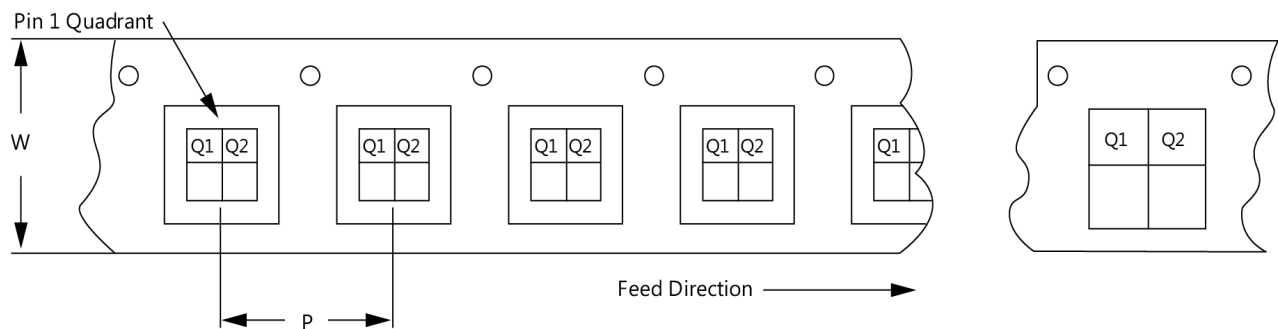

Carrier Tape Width (W), Pitch (P), Feed Direction and Pin 1 Quadrant Information



Revision History

Revision Date	Description of Change
December 19, 2019	Preliminary Data Sheet.
August 25, 2023	Release Ø Data Sheet.
November 7, 2023	Updated Thermal Resistance (Stage 1 & Stage 2). Updated Junction Temperature Plot. Added Psat Lower Limit specification.
January 9, 2025	Updated M18 & M20 on evaluation board BOM.
January 22, 2025	Lowered low end of frequency range from 300 to 100 MHz.



Data Sheet Classifications

Data Sheet Status	Notes
Advance	S-parameter and NF data based on EM simulations for the fully packaged device using foundry-supplied transistor S-parameters. Linearity estimates based on device size, bias condition and experience with related devices.
Preliminary	All data based on evaluation board measurements taken within the Guerrilla RF Applications Lab. Any MIN/MAX limits represented within the data sheet are based solely on <i>estimated</i> part-to-part variations and process spreads. All parametric values are subject to change pending the collection of additional data.
Release Ø	All data based on measurements taken with <i>production-released</i> material. TYP values are based on a combination of ATE and bench-level measurements, with MIN/MAX limits defined using <i>modelled estimates</i> that account for part-to-part variations and expected process spreads. Although unlikely, future refinements to the TYP/MIN/MAX values may be in order as multiple lots are processed through the factory.
Release A-Z	All data based on measurements taken with production-released material <i>derived from multiple lots which have been fabricated over an extended period of time</i> . MIN/MAX limits may be refined over previous releases as more statistically significant data is collected to account for process spreads.

Information in this data sheet is specific to the Guerrilla RF, Inc. ("Guerrilla RF") product identified.

This data sheet, including the information contained in it, is provided by Guerrilla RF as a service to its customers and may be used for informational purposes only by the customer. Guerrilla RF assumes no responsibility for errors or omissions on this data sheet or the information contained herein. Information provided is believed to be accurate and reliable, however, no responsibility is assumed by Guerrilla RF for its use, nor for any infringement of patents, or other rights of third parties, resulting from its use. Guerrilla RF assumes no liability for any data sheet, data sheet information, materials, products, product information, or other information provided hereunder, including the sale, distribution, reproduction or use of Guerrilla RF products, information or materials.

No license, whether express, implied, by estoppel, by implication or otherwise granted by this data sheet for any intellectual property of Guerrilla RF, or any third party, including without limitation, patents, patent rights, copyrights, trademarks, and trade secrets. All rights are reserved by Guerrilla RF.

All information herein, products, product information, data sheets, and data sheet information are subject to change and availability without notice. Guerrilla RF reserves the right to change component circuitry, recommended application circuitry and specifications at any time without prior notice. Guerrilla RF may further change its data sheet, product information, documentation, products, services, specifications or product descriptions at any time, without notice. Guerrilla RF makes no commitment to update any materials or information and shall have no responsibility whatsoever for conflicts, incompatibilities, or other difficulties arising from any future changes.

GUERRILLA RF INFORMATION, PRODUCTS, PRODUCT INFORMATION, DATA SHEETS AND DATA SHEET INFORMATION ARE PROVIDED "AS IS" AND WITHOUT WARRANTY OF ANY KIND, WHETHER EXPRESS, IMPLIED, STATUTORY, OR OTHERWISE, INCLUDING FITNESS FOR A PARTICULAR PURPOSE OR USE, MERCHANTABILITY, PERFORMANCE, QUALITY OR NON-INFRINGEMENT OF ANY INTELLECTUAL PROPERTY RIGHT; ALL SUCH WARRANTIES ARE HEREBY EXPRESSLY DISCLAIMED. GUERRILLA RF DOES NOT WARRANT THE ACCURACY OR COMPLETENESS OF THE INFORMATION, TEXT, GRAPHICS OR OTHER ITEMS CONTAINED WITHIN THESE MATERIALS. GUERRILLA RF SHALL NOT BE LIABLE FOR ANY DAMAGES, INCLUDING BUT NOT LIMITED TO ANY SPECIAL, INDIRECT, INCIDENTAL, STATUTORY, OR CONSEQUENTIAL DAMAGES, INCLUDING WITHOUT LIMITATION, LOST REVENUES OR LOST PROFITS THAT MAY RESULT FROM THE USE OF THE MATERIALS OR INFORMATION, WHETHER OR NOT THE RECIPIENT OF MATERIALS HAS BEEN ADVISED OF THE POSSIBILITY OF SUCH DAMAGE.

Customers are solely responsible for their use of Guerrilla RF products in the Customer's products and applications or in ways which deviate from Guerrilla RF's published specifications, either intentionally or as a result of design defects, errors, or operation of products outside of published parameters or design specifications. Customers should include design and operating safeguards to minimize these and other risks. Guerrilla RF assumes no liability or responsibility for applications assistance, customer product design, or damage to any equipment resulting from the use of Guerrilla RF products outside of stated published specifications or parameters.

Looking for pricing, stock, or lifecycle information?

Click below to explore more details on WIN SOURCE:

 [View GRF5504 on WIN SOURCE](#)

 [Guerrilla RF, Inc. Information](#)

Optimize Your Supply Chain with WIN SOURCE Solutions

-  Global Sourcing Solution
-  Obsolete Management
-  Cost Control Management
-  Shortage Management
-  Alternative Solution
-  Excess Inventory Management