



**THE DATASHEET OF
HA7-5147-2**



HA-5147

120MHz, Ultra-Low Noise Precision Operational Amplifiers

FN2910
Rev 1.00
November 6, 2015

The [HA-5147](#) operational amplifier features an unparalleled combination of precision DC and wideband high speed characteristics. Utilizing the Intersil D. I. technology and advanced processing techniques, this unique design unites low noise ($3.2\text{nV}/\sqrt{\text{Hz}}$) precision instrumentation performance with high speed ($35\text{V}/\mu\text{s}$) wideband capability.

This amplifier's impressive list of features include low V_{OS} (30mV), wide gain bandwidth (120MHz), high open loop gain (1500V/mV) and high CMRR (120dB). Additionally, this flexible device operates over a wide supply range ($\pm 5\text{V}$ to $\pm 20\text{V}$) while consuming only 140mW of power.

Using the HA-5147 allows designers to minimize errors while maximizing speed and bandwidth in applications requiring gains greater than ten.

This device is ideally suited for low level transducer signal amplifier circuits. Other applications which can utilize the HA-5147's qualities include instrumentation amplifiers, pulse or RF amplifiers, audio preamplifiers and signal conditioning circuits.

This device can easily be used as a design enhancement by directly replacing the 725, OP25, OP06, OP07, OP27 and OP37 where gains are greater than ten.

Features

- Slew rate $35\text{V}/\mu\text{s}$
- Wide gain bandwidth ($A_V \geq 10$) 120MHz
- Low noise $3.2\text{nV}/\sqrt{\text{Hz}}$ at 1kHz
- Low V_{OS} 30 μV
- High CMRR 120dB
- High gain 1500V/mV

Applications

- High speed signal conditioners
- Wide bandwidth instrumentation amplifiers
- Low level transducer amplifiers
- Fast, low level voltage comparators
- Highest quality audio preamplifiers
- Pulse/RF amplifiers
- For further design ideas see application note [AN553](#)

Pin Configuration

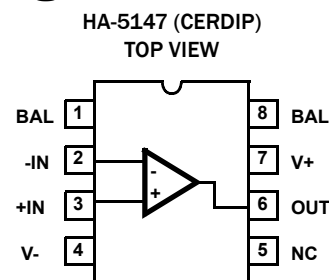

Ordering Information

PART NUMBER	PART MARKING	TEMP. RANGE (°C)	PACKAGE	PKG. DWG. #
HA7-5147-2	HA7- 5147-2	-55 to +125	8 Ld CerDIP	F8.3A
HA7-5147R5254 (Note 1)	HA7- 5147R5254	-55 to +125	8 Ld CerDIP with Pb-free Hot Solder DIP Lead Finish (SnAgCu)	F8.3A

NOTE:

1. Intersil Pb-free hermetic packaged products employ SnAgCu or Au termination finish, which are RoHS compliant termination finishes and compatible with both SnPb and Pb-free soldering operations. Ceramic dual in-line packaged products (CerDIPs) do contain lead (Pb) in the seal glass and die attach glass materials. However, lead in the glass materials of electronic components are currently exempted per the RoHS directive. Therefore, ceramic dual inline packages with Pb-free termination finish are considered to be RoHS compliant.

Absolute Maximum Ratings $T_A = +25^\circ\text{C}$

Voltage Between V+ and V- Terminals 44V
 Differential Input Voltage (Note 2) 0.7V
 Output Current Full Short-circuit Protection

Thermal Information

Thermal Resistance (Typical) θ_{JA} ($^\circ\text{C}/\text{W}$) θ_{JC} ($^\circ\text{C}/\text{W}$)
 CERDIP Package (Note 3) 135 50
 Maximum Junction Temperature (Hermetic Package) +175 $^\circ\text{C}$
 Maximum Storage Temperature Range -65 $^\circ\text{C}$ to +150 $^\circ\text{C}$
 Maximum Lead Temperature (Soldering 10s) +300 $^\circ\text{C}$

Operating Conditions

Temperature Range

HA-5147-2 -55 $^\circ\text{C}$ to +125 $^\circ\text{C}$

CAUTION: Stresses above those listed in "Absolute Maximum Ratings" may cause permanent damage to the device. This is a stress only rating and operation of the device at these or any other conditions above those indicated in the operational sections of this specification is not implied.

NOTES:

- For differential input voltages greater than 0.7V, the input current must be limited to 25mA to protect the back-to-back input diodes.
- θ_{JA} is measured with the component mounted on an evaluation PC board in free air.

Electrical Specifications $V_{\text{SUPPLY}} = \pm 15\text{V}$, $C_L \leq 50\text{pF}$, $R_S \leq 100\Omega$.

PARAMETER	TEST CONDITIONS	TEMP. ($^\circ\text{C}$)	MIN	TYP	MAX	UNITS
INPUT CHARACTERISTICS						
Offset Voltage		25	-	30	100	μV
		Full	-	70	300	μV
Average Offset Voltage Drift		Full	-	0.4	1.8	$\mu\text{V}/^\circ\text{C}$
Bias Current		25	-	15	80	nA
		Full	-	35	150	nA
Offset Current		25	-	12	75	nA
		Full	-	30	135	nA
Common Mode Range		Full	± 10.3	± 11.5	-	V
Differential Input Resistance (Note 4)		25	0.8	4	-	M Ω
Input Noise Voltage (Note 5)	0.1Hz to 10Hz	25	-	0.09	0.25	$\mu\text{V}_{\text{p-p}}$
Input Noise Voltage Density (Note 6)	f = 10Hz	25	-	3.8	8.0	$\text{nV}/\sqrt{\text{Hz}}$
	f = 100Hz		-	3.3	4.5	$\text{nV}/\sqrt{\text{Hz}}$
	f = 1000Hz		-	3.2	3.8	$\text{nV}/\sqrt{\text{Hz}}$
Input Noise Current Density (Note 6)	f = 10Hz	25	-	1.7	-	$\text{pA}/\sqrt{\text{Hz}}$
	f = 100Hz		-	1.0	-	$\text{pA}/\sqrt{\text{Hz}}$
	f = 1000Hz		-	0.4	0.6	$\text{pA}/\sqrt{\text{Hz}}$
TRANSFER CHARACTERISTICS						
Minimum Stable Gain		25	10	-	-	V/V
Large Signal Voltage Gain	$V_{\text{OUT}} = \pm 10\text{V}$, $R_L = 2\text{k}\Omega$	25	700	1500	-	V/mV
		Full	300	800	-	V/mV
Common Mode Rejection Ratio	$V_{\text{CM}} = \pm 10\text{V}$	Full	100	120	-	dB
Gain-bandwidth Product	f = 10kHz	25	120	140	-	MHz
	f = 1MHz		-	120	-	MHz

Electrical Specifications $V_{\text{SUPPLY}} = \pm 15\text{V}$, $C_L \leq 50\text{pF}$, $R_S \leq 100\Omega$. (Continued)

PARAMETER	TEST CONDITIONS	TEMP. (°C)	MIN	TYP	MAX	UNITS
OUTPUT CHARACTERISTICS						
Output Voltage Swing	$R_L = 600\Omega$	25	± 10.0	± 11.5	-	V
	$R_L = 2\text{k}\Omega$	Full	± 11.4	± 13.5	-	V
Full Power Bandwidth (Note 7)		25	445	500	-	kHz
Output Resistance	Open Loop	25	-	70	-	Ω
Output Current		25	16.5	25	-	mA
TRANSIENT RESPONSE (Note 8)						
Rise Time		25	-	22	50	ns
Slew Rate	$V_{\text{OUT}} = \pm 3\text{V}$	25	28	35	-	V/ μs
Settling Time	Note 9	25	-	400	-	ns
Overshoot		25	-	20	40	%
POWER SUPPLY CHARACTERISTICS						
Supply Current		25	-	3.5	-	mA
		Full	-	-	4.0	mA
Power Supply Rejection Ratio	$V_S = \pm 4\text{V to } \pm 18\text{V}$	Full	-	16	51	$\mu\text{V/V}$

NOTES:

4. This parameter value is based upon design calculations.
5. Refer to Typical Performance section starting on [page 6](#).
6. The limits for this parameter are established based on lab characterization, and reflect lot-to-lot variation.
7. Full power bandwidth established based on slew rate measurement using: $\text{FPBW} = \frac{\text{Slew Rate}}{2\pi V_{\text{PEAK}}}$.
8. Refer to Test Circuits section on [page 4](#).
9. Settling time is specified to 0.1% of final value for a 10V output step and $A_V = -10$.

Test Circuits and Waveforms

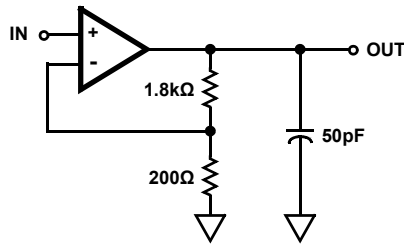
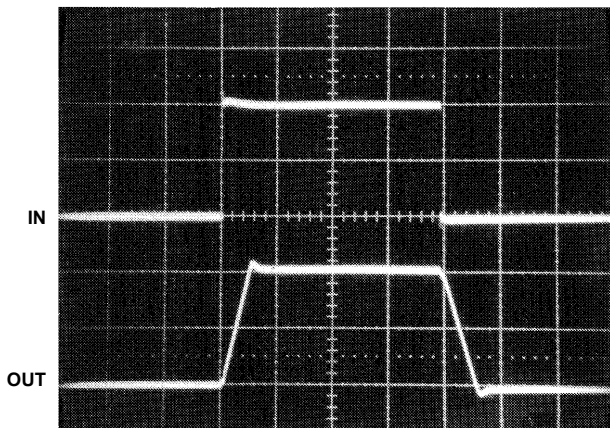
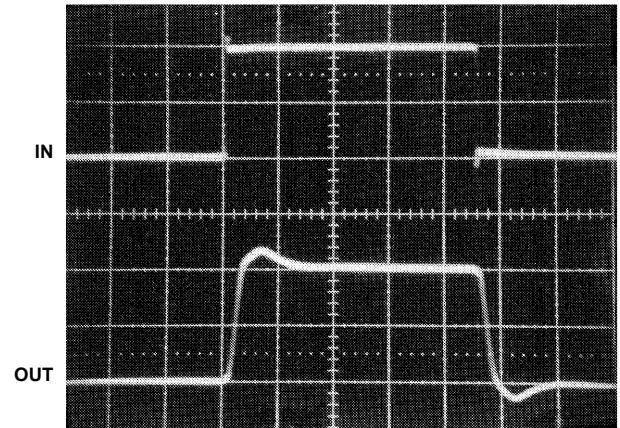

FIGURE 1. LARGE AND SMALL SIGNAL RESPONSE TEST CIRCUIT



Vertical Scale: Input = 0.5V/DIV
 Output = 5V/DIV
 Horizontal Scale: 500ns/DIV

FIGURE 2. LARGE SIGNAL RESPONSE



Vertical Scale: Input = 10mV/DIV
 Output = 100mV/DIV
 Horizontal Scale: 100ns/DIV

FIGURE 3. SMALL SIGNAL RESPONSE

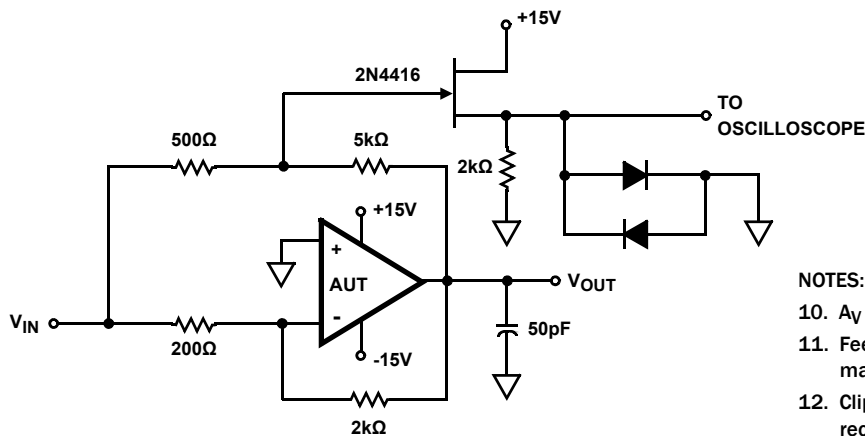

NOTES:

- 10. $A_V = -10$.
- 11. Feedback and summing resistors should be 0.1% matched.
- 12. Clipping diodes are optional. HP5082-2810 recommended.

FIGURE 4. SETTLING TIME TEST CIRCUIT

Schematic Diagram

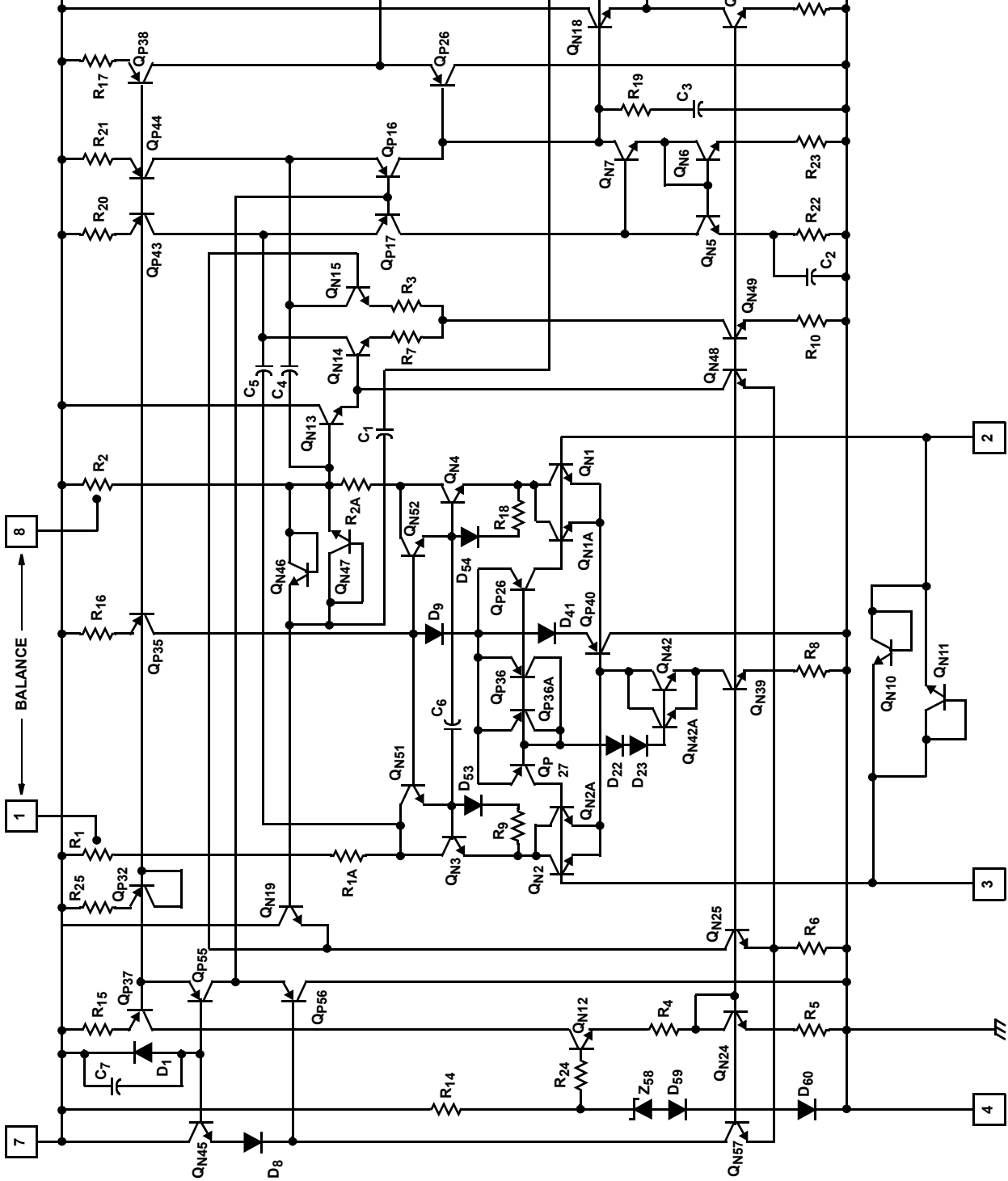

Application Information

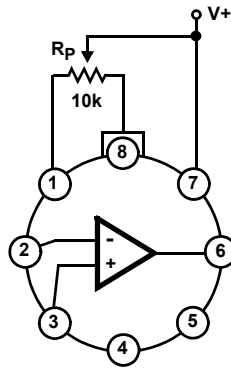

NOTE: Tested offset adjustment range is $|V_{OS} + 1mV|$ minimum referred to output. Typical range is $\pm 4mV$ with $R_p = 10k\Omega$.

FIGURE 5. SUGGESTED OFFSET VOLTAGE ADJUSTMENT

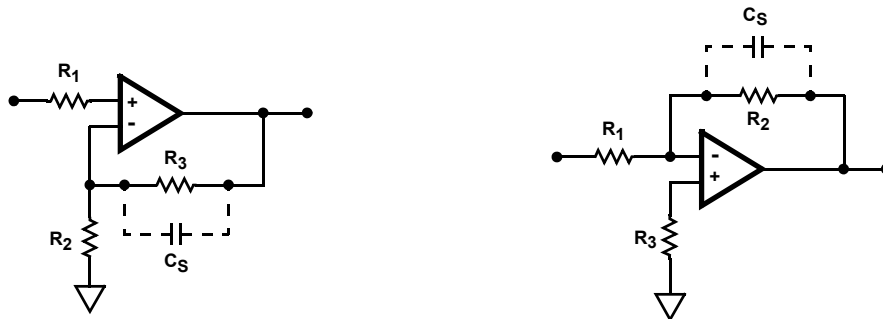

NOTE: Low resistances are preferred for low noise applications as a 1k Ω resistor has 4nV/ \sqrt{Hz} of thermal noise. Total resistances of greater than 10k Ω on either input can reduce stability. In most high resistance applications, a few picofarads of capacitance across the feedback resistor will improve stability.

FIGURE 6. SUGGESTED STABILITY CIRCUITS

Typical Performance Curves

$T_A = +25^\circ C$, $V_{SUPPLY} = \pm 15V$, unless otherwise specified.

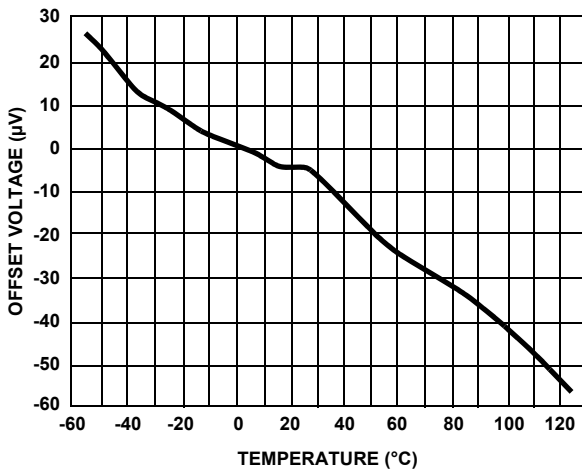

FIGURE 7. TYPICAL OFFSET VOLTAGE vs TEMPERATURE

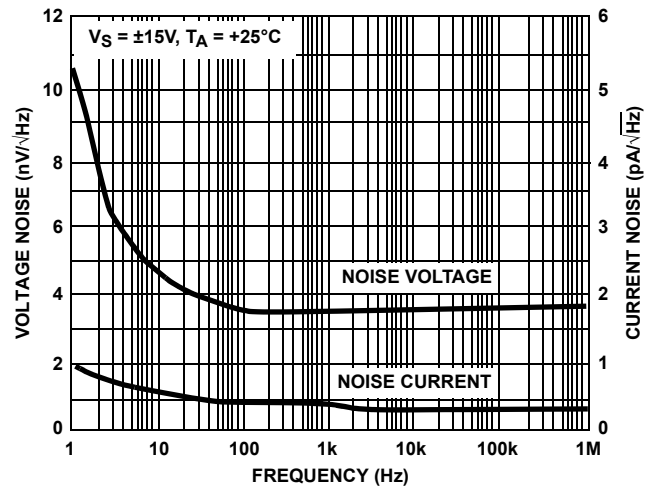

FIGURE 8. NOISE CHARACTERISTICS

Typical Performance Curves $T_A = +25^\circ\text{C}$, $V_{\text{SUPPLY}} = \pm 15\text{V}$, unless otherwise specified. (Continued)

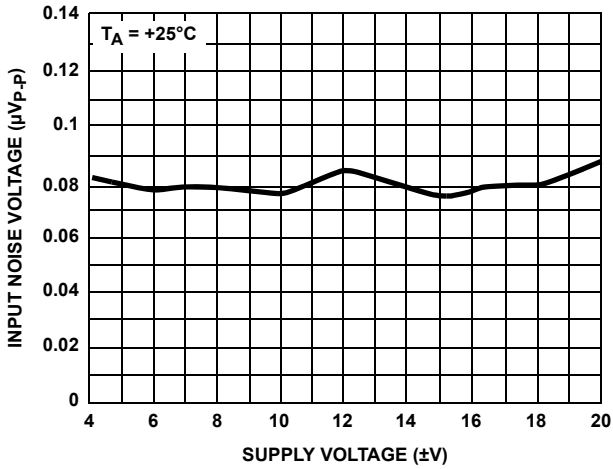

FIGURE 9. NOISE vs SUPPLY VOLTAGE

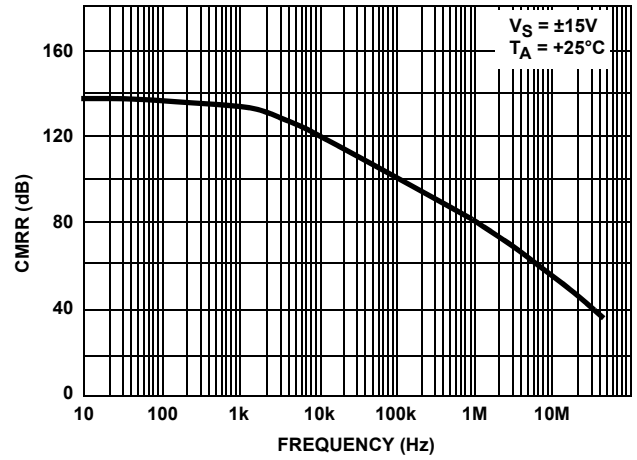

FIGURE 10. CMRR vs FREQUENCY

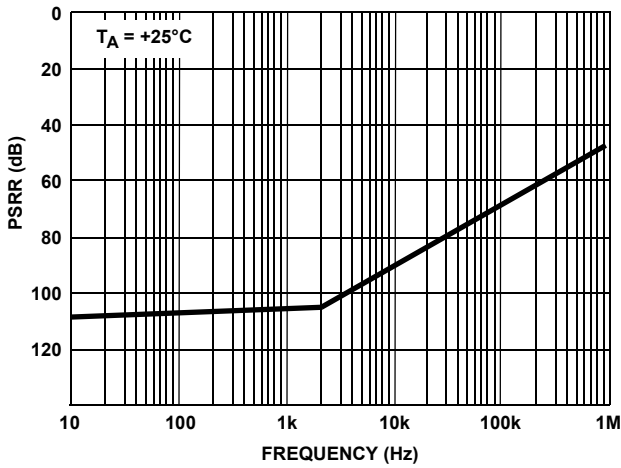

FIGURE 11. PSRR vs FREQUENCY

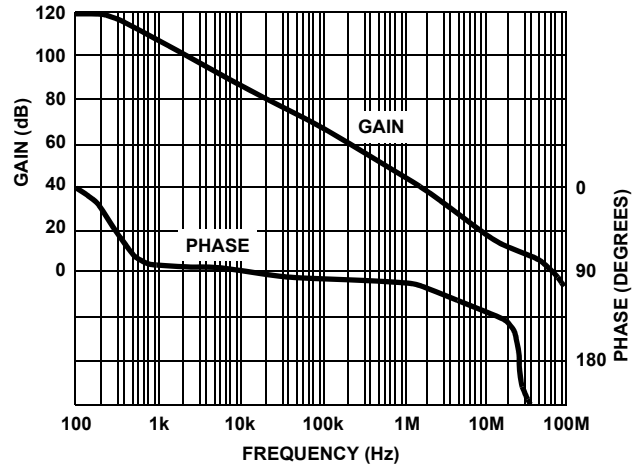

FIGURE 12. OPEN LOOP GAIN AND PHASE vs FREQUENCY

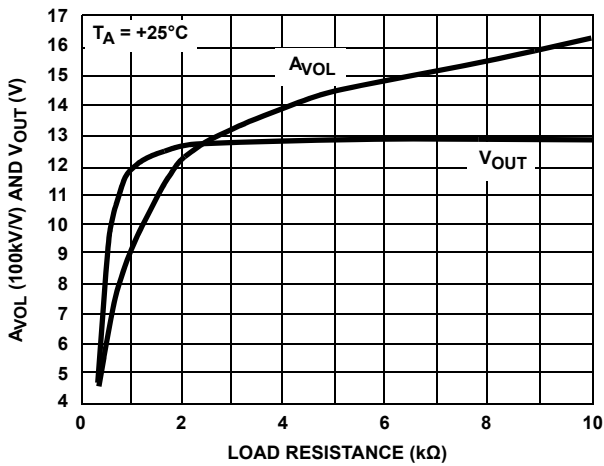

FIGURE 13. A_{VOL} AND V_{OUT} vs LOAD RESISTANCE

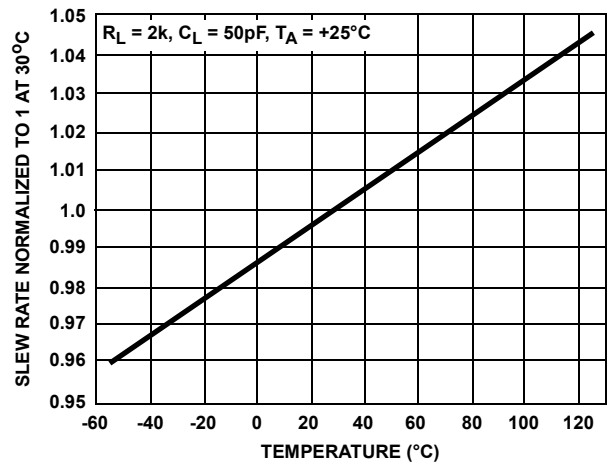

FIGURE 14. NORMALIZED SLEW RATE vs TEMPERATURE

Typical Performance Curves $T_A = +25^\circ\text{C}$, $V_{\text{SUPPLY}} = \pm 15\text{V}$, unless otherwise specified. (Continued)

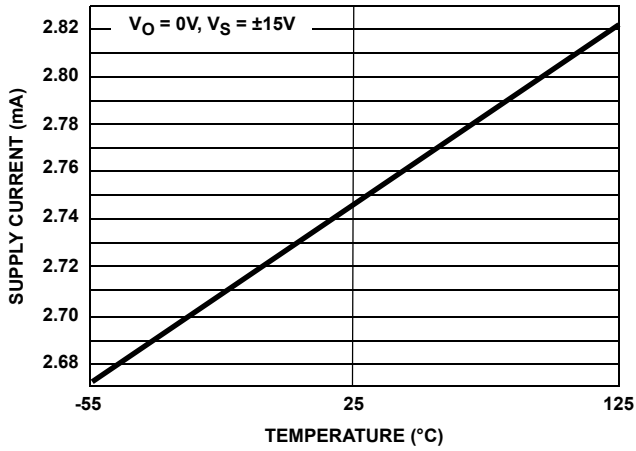

FIGURE 15. SUPPLY CURRENT vs TEMPERATURE

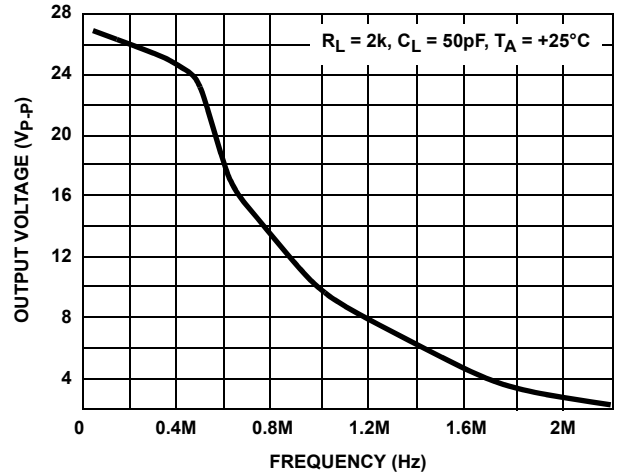

FIGURE 16. $V_{\text{OUT MAX}}$ (UNDISTORTED SINEWAVE OUTPUT) vs FREQUENCY

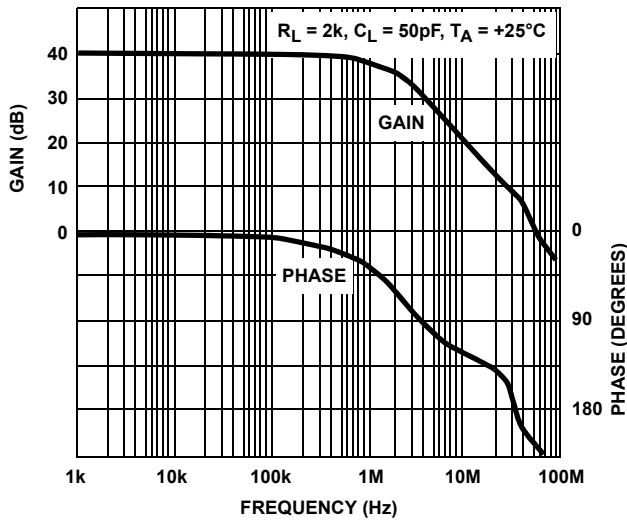
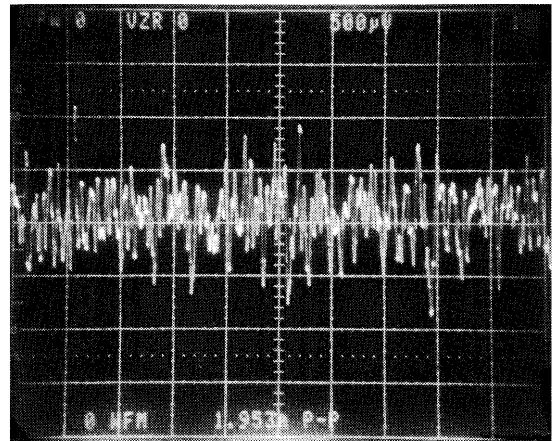

FIGURE 17. CLOSED LOOP GAIN AND PHASE vs FREQUENCY



$A_{\text{CL}} = 25,000\text{V/V}$; $E_{\text{N}} = 0.08\mu\text{V}_{\text{P-P RTI}}$
Horizontal Scale = 1s/DIV; Vertical Scale = 0.02µV/DIV

FIGURE 18. PEAK-TO-PEAK NOISE VOLTAGE (0.1Hz TO 10Hz)

Die Characteristics

DIE DIMENSIONS:

104 mils x 65 mils x 19 mils
2650 μ m x 1650 μ m x 483 μ m

METALLIZATION:

Type: Al, 1% Cu
Thickness: 16k \AA \pm 2k \AA

SUBSTRATE POTENTIAL (POWERED UP):

V-

PASSIVATION:

Type: Nitride (Si_3N_4) over Silox (SiO_2 , 5% Phos.)
Silox Thickness: 12k \AA \pm 2k \AA
Nitride Thickness: 3.5k \AA \pm 1.5k \AA

TRANSISTOR COUNT:

63

PROCESS:

Bipolar Dielectric Isolation

Metallization Mask Layout

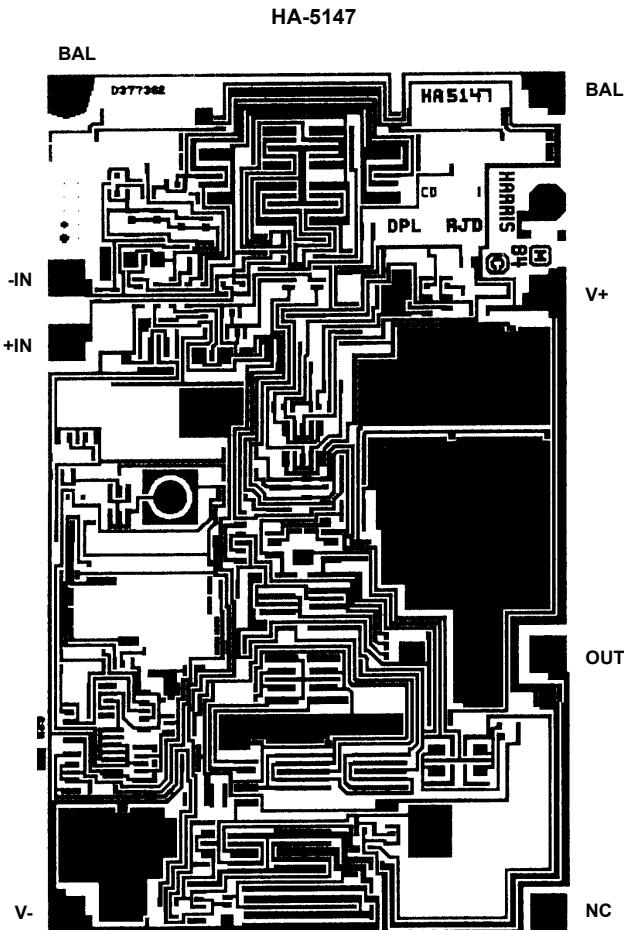

Revision History

The revision history provided is for informational purposes only and is believed to be accurate, but not warranted. Please go to the web to make sure that you have the latest revision.

DATE	REVISION	CHANGE
November 6, 2015	FN2910.10	Updated to newest standards and layout. Figure 18 page 8. Changed Vertical Scale = 0.002 μ V/Div to: Vertical Scale = 0.02 μ V/DIV Added Revision History and About Intersil sections to page 10

About Intersil

Intersil Corporation is a leading provider of innovative power management and precision analog solutions. The company's products address some of the largest markets within the industrial and infrastructure, mobile computing and high-end consumer markets.

For the most updated datasheet, application notes, related documentation and related parts, please see the respective product information page found at www.intersil.com.

You may report errors or suggestions for improving this datasheet by visiting www.intersil.com/ask.

Reliability reports are also available from our website at www.intersil.com/support

Ceramic Dual-In-Line Frit Seal Packages (CERDIP)

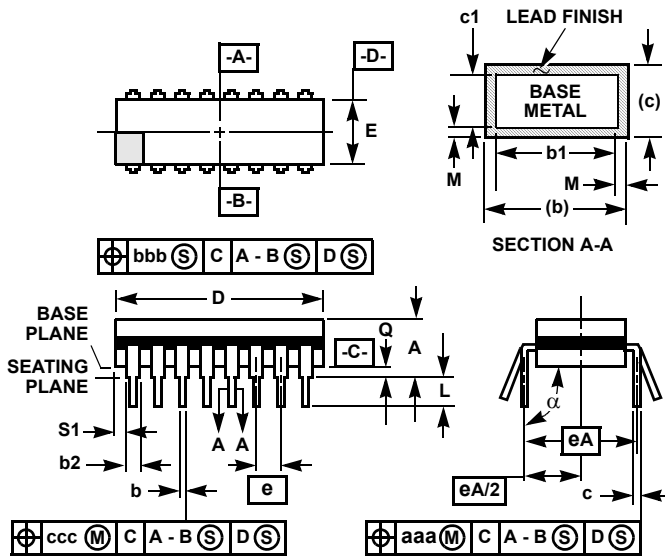

**F8.3A MIL-STD-1835 GDIP1-T8 (D-4, CONFIGURATION A)
8 LEAD CERAMIC DUAL-IN-LINE FRIT SEAL PACKAGE**

SYMBOL	INCHES		MILLIMETERS		NOTES
	MIN	MAX	MIN	MAX	
A	-	0.200	-	5.08	-
b	0.014	0.026	0.36	0.66	2
b1	0.014	0.023	0.36	0.58	3
b2	0.045	0.065	1.14	1.65	-
b3	0.023	0.045	0.58	1.14	4
c	0.008	0.018	0.20	0.46	2
c1	0.008	0.015	0.20	0.38	3
D	-	0.405	-	10.29	5
E	0.220	0.310	5.59	7.87	5
e	0.100 BSC		2.54 BSC		-
eA	0.300 BSC		7.62 BSC		-
eA/2	0.150 BSC		3.81 BSC		-
L	0.125	0.200	3.18	5.08	-
Q	0.015	0.060	0.38	1.52	6
S1	0.005	-	0.13	-	7
α	90°	105°	90°	105°	-
aaa	-	0.015	-	0.38	-
bbb	-	0.030	-	0.76	-
ccc	-	0.010	-	0.25	-
M	-	0.0015	-	0.038	2, 3
N	8		8		8

Rev. 0 4/94

NOTES:

1. Index area: A notch or a pin one identification mark shall be located adjacent to pin one and shall be located within the shaded area shown. The manufacturer's identification shall not be used as a pin one identification mark.
2. The maximum limits of lead dimensions b and c or M shall be measured at the centroid of the finished lead surfaces, when solder dip or tin plate lead finish is applied.
3. Dimensions b1 and c1 apply to lead base metal only. Dimension M applies to lead plating and finish thickness.
4. Corner leads (1, N, N/2, and N/2+1) may be configured with a partial lead paddle. For this configuration dimension b3 replaces dimension b2.
5. This dimension allows for off-center lid, meniscus, and glass overrun.
6. Dimension Q shall be measured from the seating plane to the base plane.
7. Measure dimension S1 at all four corners.
8. N is the maximum number of terminal positions.
9. Dimensioning and tolerancing per ANSI Y14.5M - 1982.
10. Controlling dimension: INCH

© Copyright Intersil Americas LLC 2003-2015. All Rights Reserved.
All trademarks and registered trademarks are the property of their respective owners.

For additional products, see www.intersil.com/en/products.html

Intersil products are manufactured, assembled and tested utilizing ISO9001 quality systems as noted in the quality certifications found at www.intersil.com/en/support/qualandreliability.html

Intersil products are sold by description only. Intersil may modify the circuit design and/or specifications of products at any time without notice, provided that such modification does not, in Intersil's sole judgment, affect the form, fit or function of the product. Accordingly, the reader is cautioned to verify that datasheets are current before placing orders. Information furnished by Intersil is believed to be accurate and reliable. However, no responsibility is assumed by Intersil or its subsidiaries for its use; nor for any infringements of patents or other rights of third parties which may result from its use. No license is granted by implication or otherwise under any patent or patent rights of Intersil or its subsidiaries.

For information regarding Intersil Corporation and its products, see www.intersil.com

Looking for pricing, stock, or lifecycle information?

Click below to explore more details on WIN SOURCE:

 [View HA7-5147-2 on WIN SOURCE](#)

 [Intersil Information](#)

Optimize Your Supply Chain with WIN SOURCE Solutions

-  Global Sourcing Solution
-  Obsolete Management
-  Cost Control Management
-  Shortage Management
-  Alternative Solution
-  Excess Inventory Management