



**H21LTB**

**H21LTI**

**H21LOB**

**H21LOI**

**PACKAGE DIMENSIONS**

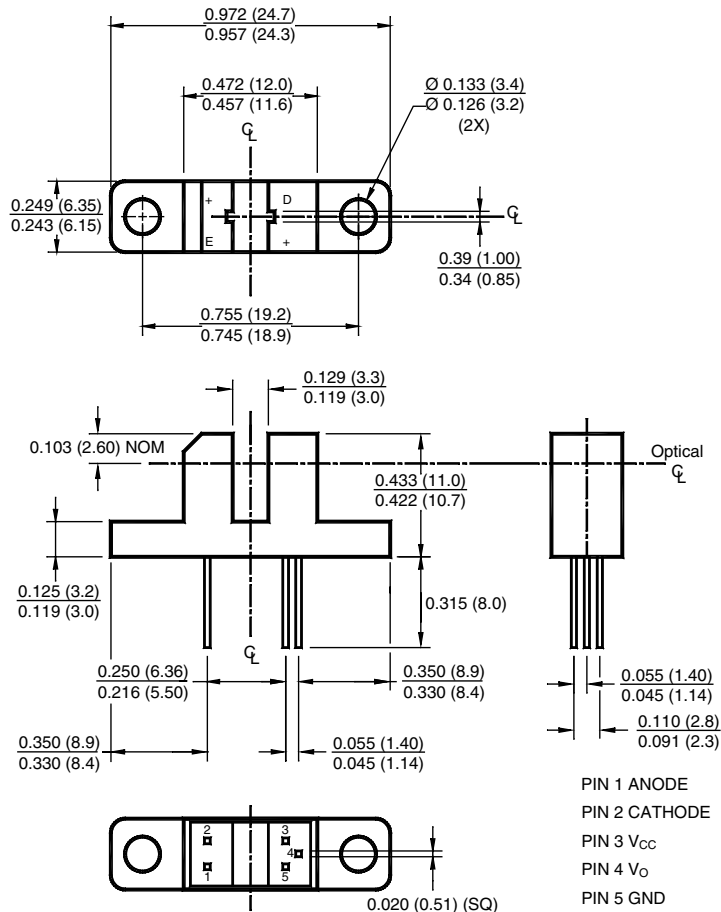

**NOTES:**

1. Dimensions for all drawings are in inches (mm).
2. Tolerance of ± .010 (.25) on all non-nominal dimensions unless otherwise specified.

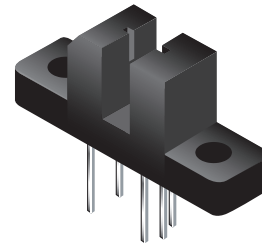

**Features**

- Low cost
- 0.035" apertures
- Black plastic opaque housing
- Mounting tabs on housing
- Choice of inverter or buffer output functions
- Choice of open-collector or totem-pole output configuration
- TTL/CMOS compatible output functions

**Description**

The H21L series are slotted optical switches designed for multipurpose non contact sensing. They consist of a GaAs LED and a silicon OPTOLOGIC® sensor packaged in an injection molded housing and facing each other across a .124" (3.15 mm) gap. The output is either inverting or non-inverting, with a choice of totem-pole or open-collector configuration for TTL/CMOS compatibility

**H21LTB**

**H21LTI**

**H21LOB**

**H21LOI**

**Part Number Definitions**

H21LTB	Totem-pole, buffer output
H21LTI	Totem-pole, inverter output
H21LOB	Open-collector, buffer output
H21LOI	Open-collector, inverter output

**Input/Output Table**

Part Number	LED	Output
H21LTB	On	High
H21LTB	Off	Low
H21LTI	On	Low
H21LTI	Off	High
H21LOB	On	High
H21LOB	Off	Low
H21LOI	On	Low
H21LOI	Off	High

**H21LTB**

**H21LTI**

**H21LOB**

**H21LOI**

**Schematics**

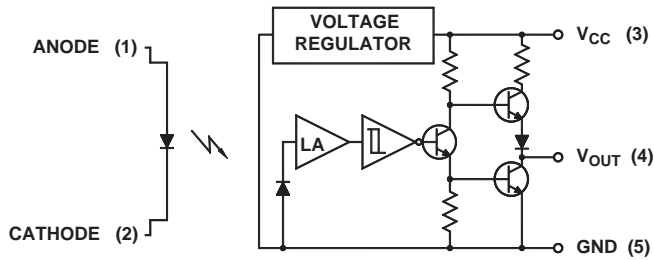

**H21LTB**

**Totem-Pole Output Buffer**

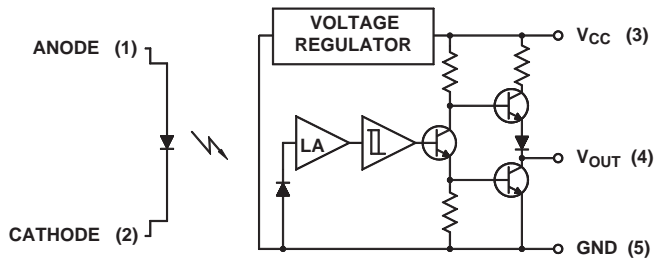

**H21LTI**

**Totem-Pole Output inverter**

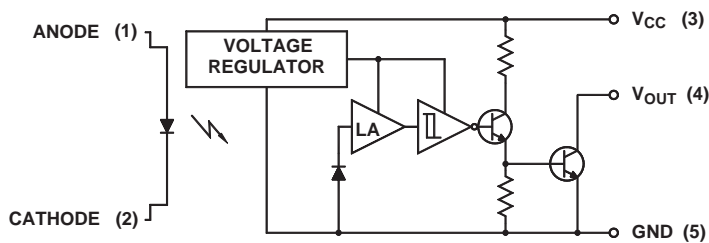

**H21LOB**

**Open-Collector Output Buffer**

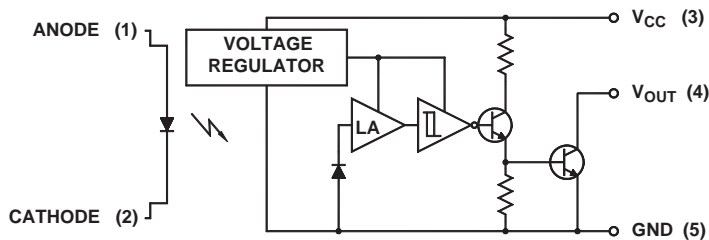

**H21LOI**

**Open-Collector Output Inverter**

**H21LTB**

**H21LTI**

**H21LOB**

**H21LOI**

<b>Absolute Maximum Ratings</b> ( $T_A = 25^\circ\text{C}$ unless otherwise specified)			
<b>Parameter</b>	<b>Symbol</b>	<b>Rating</b>	<b>Units</b>
Operating Temperature	$T_{OPR}$	-40 to +85	$^\circ\text{C}$
Storage Temperature	$T_{STG}$	-40 to +85	$^\circ\text{C}$
Soldering Temperature (Iron) <sup>(3,4,5,6)</sup>	$T_{SOL-I}$	240 for 5 sec	$^\circ\text{C}$
Soldering Temperature (Flow) <sup>(3,4,6)</sup>	$T_{SOL-F}$	260 for 10 sec	$^\circ\text{C}$
<b>Input (Emitter)</b>			
Continuous Forward Current	$I_F$	50	mA
Reverse Voltage	$V_R$	6	V
Power Dissipation <sup>(1)</sup>	$P_D$	100	mW
<b>Output (Sensor)</b>			
Output Current	$I_O$	50	mA
Supply Voltage	$V_{CC}$	4.0 to 16	V
Output Voltage	$V_O$	30	V
Power Dissipation <sup>(2)</sup>	$P_D$	150	mW

**H21LTB**

**H21LTI**

**H21LOB**

**H21LOI**

Electrical/Optical Characteristics (T <sub>A</sub> = 25°C)						
Parameter	Test Conditions	Symbol	Min.	Typ	Max.	Units
<b>Input (Emitter)</b>						
Forward Voltage	I <sub>F</sub> = 20 mA	V <sub>F</sub>	—		1.5	V
Reverse Leakage Current	V <sub>R</sub> = 5 V	I <sub>R</sub>	—		10	μA
<b>Output (Sensor)</b>						
Supply Current	V <sub>CC</sub> = 5 V	I <sub>CC</sub>	—		5	mA
<b>Coupled</b>						
Low Level Output Voltage H21LTB, H21LOB	I <sub>F</sub> = 0 mA, V <sub>CC</sub> = 5 V, R <sub>L</sub> = 100 Ω	V <sub>OL</sub>	—		0.4	V
Low Level Output Voltage H21LTI, H21LOI	I <sub>F</sub> = 15 mA, V <sub>CC</sub> = 5 V, R <sub>L</sub> = 360 Ω	V <sub>OL</sub>	—		0.4	V
High Level Output Voltage H21LTB	I <sub>F</sub> = 15 mA, V <sub>CC</sub> = 5 V, I <sub>OH</sub> = -800 μA	V <sub>OH</sub>	2.4		—	V
High Level Output Voltage H21LTI	I <sub>F</sub> = 0 mA, V <sub>CC</sub> = 5 V, I <sub>OH</sub> = -800 μA	V <sub>OH</sub>	2.4		—	V
High Level Output Current H21LOB	I <sub>F</sub> = 0 mA, V <sub>CC</sub> = 5 V, I <sub>OH</sub> = -800 μA	I <sub>OH</sub>			100	μA
High Level Output Current H21LOI	I <sub>F</sub> = 0 mA, V <sub>CC</sub> = 5 V, V <sub>OH</sub> = 30 V	I <sub>OH</sub>	—		100	μA
Turn on Threshold Current	V <sub>CC</sub> = 5 V, R <sub>L</sub> = 360 Ω	I <sub>F</sub> (+)	—		15	mA
Turn off Threshold Current	V <sub>CC</sub> = 5 V, R <sub>L</sub> = 360 Ω	I <sub>F</sub> (-)	0.50		—	mA
Hysteresis Ratio		I <sub>F</sub> (+) / I <sub>F</sub> (-)		1.2		
Propagation Delay	V <sub>CC</sub> = 5 V, R <sub>L</sub> = 360 Ω (See Fig. 9)	t <sub>PLH</sub> , t <sub>PHL</sub>		5		μs
Output Rise and Fall Time	V <sub>CC</sub> = 5 V, R <sub>L</sub> = 360 Ω (See Fig. 9)	t <sub>r</sub> , t <sub>f</sub>		70		ns

**Notes:** (Applies to Max Ratings and Characteristics Tables.)

1. Derate power dissipation linearly 1.67 mW/°C above 25°C.
2. Derate power dissipation linearly 2.50 mW/°C above 25°C.
3. RMA flux is recommended.
4. Methanol or isopropyl alcohols are recommended as cleaning agents.
5. Soldering iron 1/16" (1.6mm) from housing.
6. As long as leads are not under any stress or spring tension.

**H21LTB**

**H21LTI**

**H21LOB**

**H21LOI**

**Figure 1. Output Voltage vs. Input Current (Inverters)**

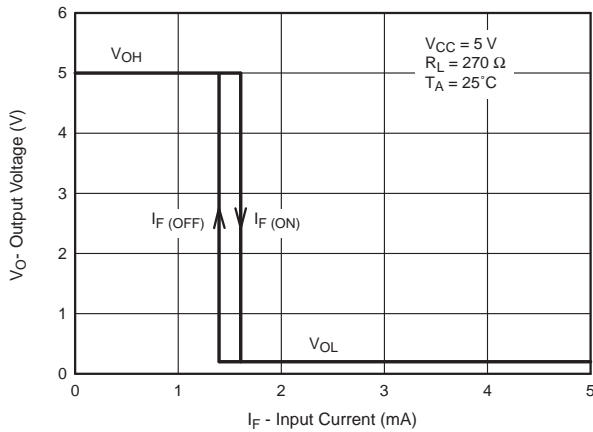

**Figure 2. Output Voltage vs. Input Current (Buffers)**

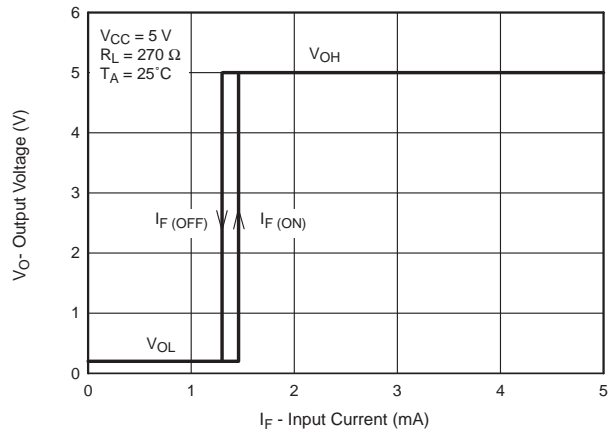

**Figure 3. Normalized Threshold Current vs. Shield Distance**

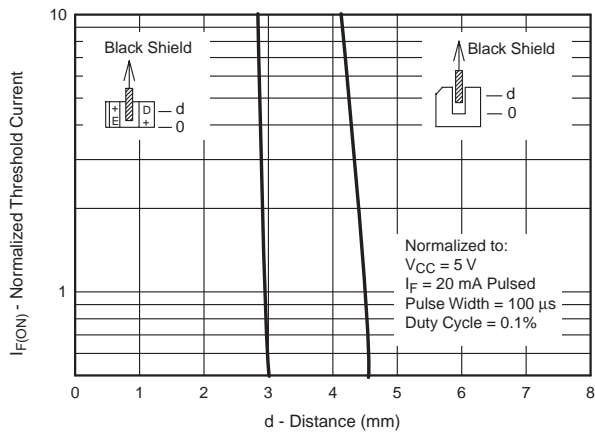

**Figure 4. Normalized Threshold Current vs. Supply Voltage**

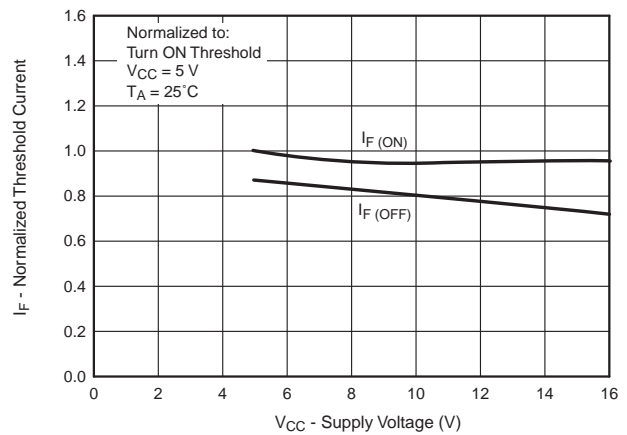

**H21LTB**

**H21LTI**

**H21LOB**

**H21LOI**

**Figure 5. Normalized Threshold Current vs. Ambient Temperature**

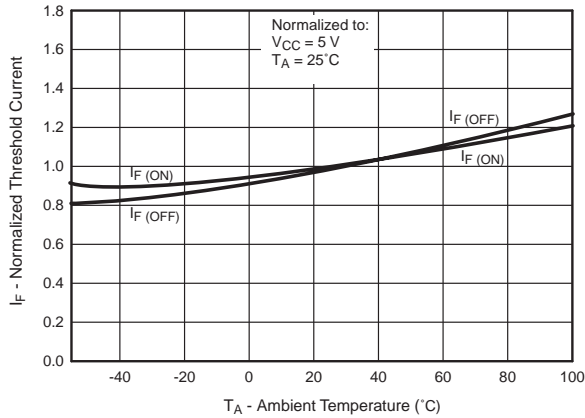

**Figure 6. Forward Current vs. Forward Voltage**

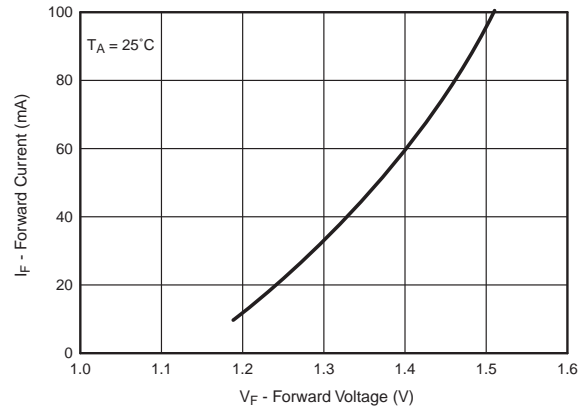

**Figure 7. Low Output Voltage vs. Output Current**

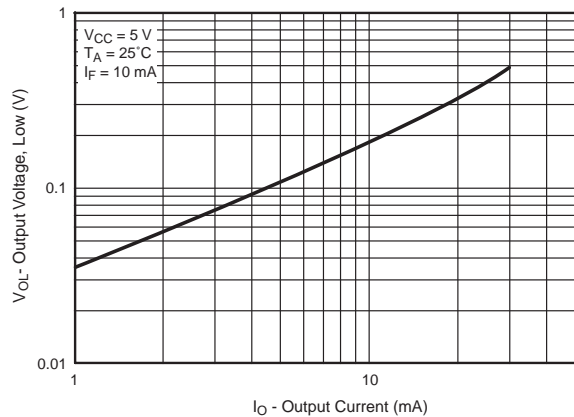

**Figure 8. Response Time vs. Forward Current**

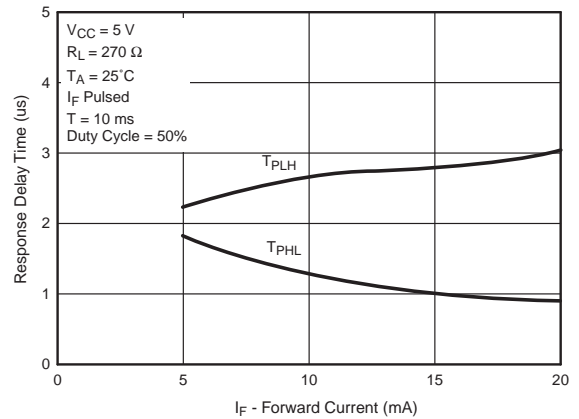

**H21LTB**

**H21LTI**

**H21LOB**

**H21LOI**

Figure 9. Switching Speed Test Circuit

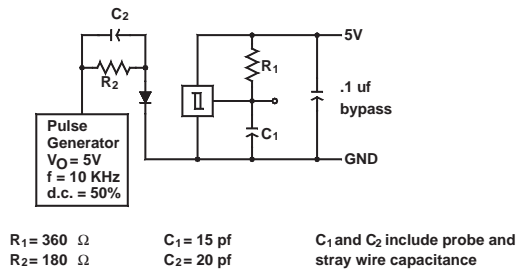

Figure 10. Typical Operating Circuit

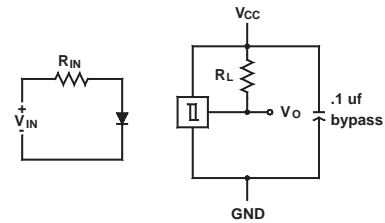

Figure 11. Switching Times Definition for Buffers

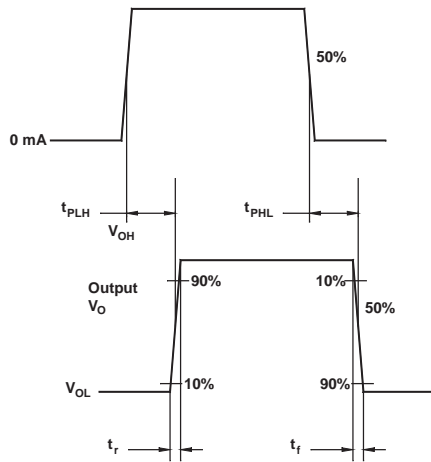
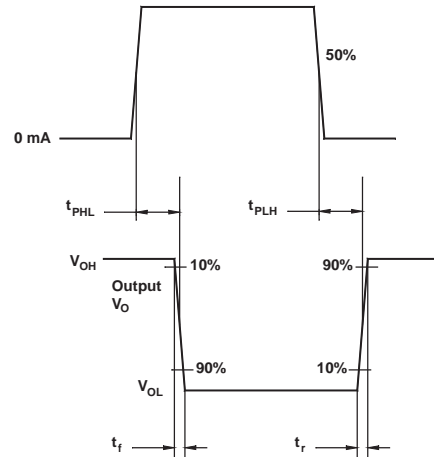

Figure 12. Switching Times Definition for Inverters





# OPTOLOGIC<sup>®</sup> OPTICAL INTERRUPTER SWITCH

---

**H21LTB****H21LTI****H21LOB****H21LOI**

---

**DISCLAIMER**

FAIRCHILD SEMICONDUCTOR RESERVES THE RIGHT TO MAKE CHANGES WITHOUT FURTHER NOTICE TO ANY PRODUCTS HEREIN TO IMPROVE RELIABILITY, FUNCTION OR DESIGN. FAIRCHILD DOES NOT ASSUME ANY LIABILITY ARISING OUT OF THE APPLICATION OR USE OF ANY PRODUCT OR CIRCUIT DESCRIBED HEREIN; NEITHER DOES IT CONVEY ANY LICENSE UNDER ITS PATENT RIGHTS, NOR THE RIGHTS OF OTHERS.

**LIFE SUPPORT POLICY**

FAIRCHILD'S PRODUCTS ARE NOT AUTHORIZED FOR USE AS CRITICAL COMPONENTS IN LIFE SUPPORT DEVICES OR SYSTEMS WITHOUT THE EXPRESS WRITTEN APPROVAL OF THE PRESIDENT OF FAIRCHILD SEMICONDUCTOR CORPORATION. As used herein:

1. Life support devices or systems are devices or systems which, (a) are intended for surgical implant into the body, or (b) support or sustain life, and (c) whose failure to perform when properly used in accordance with instructions for use provided in the labeling, can be reasonably expected to result in a significant injury of the user.
2. A critical component in any component of a life support device or system whose failure to perform can be reasonably expected to cause the failure of the life support device or system, or to affect its safety or effectiveness.

## Looking for pricing, stock, or lifecycle information?

Click below to explore more details on WIN SOURCE:

- ⊖ [View H21LTI on WIN SOURCE](#)
- ⊖ [Fairchild/ON Semiconductor Information](#)

## Optimize Your Supply Chain with WIN SOURCE Solutions

- ✓ Global Sourcing Solution
- ✓ Obsolete Management
- ✓ Cost Control Management
- ✓ Shortage Management
- ✓ Alternative Solution
- ✓ Excess Inventory Management