



**THE DATASHEET OF  
GTLP16T1655MTDX**



## GTLP16T1655

### 16-Bit LVTTTL/GTLP Universal Bus Transceiver with High Drive GTLP and Individual Byte Controls

#### General Description

The GTLP16T1655 is a 16-bit universal bus transceiver that provides LVTTTL to GTLP signal level translation. It allows for transparent, latched and clocked modes of data transfer. The device provides a high speed interface between cards operating at LVTTTL logic levels and a backplane operating at GTLP logic levels. High speed backplane operation is a direct result of GTLP's reduced output swing (<1V), reduced input threshold levels and output edge rate control. The edge rate control minimizes bus settling time. GTLP is a Fairchild Semiconductor derivative of the Gunning Transceiver Logic (GTL) JEDEC standard JESD8-3.

Fairchild's GTLP has internal edge-rate control and is process, voltage, and temperature (PVT) compensated. Its function is similar to BTL and GTL but with different output levels and receiver threshold. GTLP output LOW level is typically less than 0.5V, the output level HIGH is 1.5V and the receiver threshold is 1.0V.

#### Features

- Bidirectional interface between GTLP and LVTTTL logic levels
- Variable edge rate control pin to select desired edge rate on the GTLP backplane ( $V_{ERC}$ )
- $V_{REF}$  pin provides external supply reference voltage for receiver threshold adjustability
- Special PVT compensation circuitry to provide consistent performance over variations of process, supply voltage and temperature
- TTL compatible driver and control inputs
- Designed using Fairchild advanced BiCMOS technology
- Bushold data inputs on A port to eliminate the need for external pull-up resistors for unused inputs
- Power up/down and power off high impedance for live insertion
- Open drain on GTLP to support wired-or connection
- Flow through pinout optimizes PCB layout
- D-type flip-flop, latch and transparent data paths
- A Port source/sink  $-24\text{mA}/+24\text{mA}$
- B Port sink  $+100\text{mA}$
- Partitioned as two 8-bit transceivers with individual latch timing and output control but with a common clock
- External pin to pre-condition I/O capacitance to high state ( $V_{CCBIAS}$ )

#### Ordering Code:

Order Number	Package Number	Package Description
GTLP16T1655MTD	MTD64	64-Lead Thin Shrink Small Outline Package (TSSOP), JEDEC MO-153, 6.1mm Wide

Devices also available in Tape and Reel. Specify by appending the suffix letter "X" to the ordering code.

GTLP16T1655 16-Bit LVTTTL/GTLP Universal Bus Transceiver with High Drive GTLP and Individual Byte Controls

### Connection Diagram

1OEAB	1	64	CLK
1OEBA	2	63	1LEAB
V <sub>CC</sub>	3	62	1LEBA
1A1	4	61	VERC
GND	5	60	GND
1A2	6	59	1B1
1A3	7	58	1B2
GND	8	57	GND
1A4	9	56	1B3
GND	10	55	1B4
1A5	11	54	1B5
GND	12	53	GND
1A6	13	52	1B6
1A7	14	51	1B7
V <sub>CC</sub>	15	50	V <sub>CC</sub>
1A8	16	49	1B8
2A1	17	48	2B1
GND	18	47	GND
2A2	19	46	2B2
2A3	20	45	2B3
GND	21	44	GND
2A4	22	43	2B4
2A5	23	42	2B5
GND	24	41	V <sub>REF</sub>
2A6	25	40	2B6
GND	26	39	GND
2A7	27	38	2B7
V <sub>CC</sub>	28	37	2B8
2A8	29	36	V <sub>CCBIAS</sub>
GND	30	35	2LEAB
2OEAB	31	34	2LEBA
2OEBA	32	33	OE

### Pin Descriptions

Pin Names	Description
1OEAB	A-to-B Output Enable (Active LOW)
2OEAB	Byte 1 and Byte 2
1OEBA	B-to-A Output Enable (Active LOW)
2OEBA	Byte 1 and Byte 2
OE	Disables all I/O ports simultaneously
1LEAB	A-to-B Latch Enable (Transparent HIGH)
2LEAB	Byte 1 and Byte 2
1LEBA	B-to-A Latch Enable (Transparent HIGH)
2LEBA	Byte 1 and Byte 2
V <sub>REF</sub>	GTLP Reference Voltage
CLK	A-to-B and B-to-A Clock
1A1-1A8	A Port I/O Byte 1 and Byte 2
2A1-2A8	
1B1-1B8	B Port I/O Byte 1 and Byte 2
2B1-2B8	

### Truth Tables

(Note 1)

Inputs				Output B	Mode
OEAB	LEAB	CLK	A		
H	X	X	X	Z	High Impedance
L	H	X	L	L	Transparent
L	H	X	H	H	Transparent
L	L	↑	L	L	Registered
L	L	↑	H	H	Registered
L	L	H	X	B <sub>0</sub> (Note 2)	Previous State
L	L	L	X	B <sub>0</sub> (Note 3)	Previous State

Inputs			Outputs	
OE	OEAB (Note 4)	OEBA (Note 4)	A Port	B Port
L	L	L	Active	Active
L	L	H	Z	Active
L	H	L	Active	Z
L	H	H	Z	Z
H	X	X	Z	Z

Inputs	Output Edge
V <sub>ERC</sub>	B Port
V <sub>CC</sub>	Slow
GND	Fast

**Note 1:** A-to-B data flow is shown. B-to-A data flow is similar but uses OEBA, LEBA, CLK.

**Note 2:** Output level before the indicated steady state input conditions were established, provided CLK was HIGH prior to LEAB going LOW.

**Note 3:** Output level before the indicated steady state input conditions were established.

**Note 4:** OEAB and OEBA are byte-wide enables. Each is preceded by a number indicating the byte controlled.

## Functional Description

The GTLP16T1655 is a high drive (100 mA) 16-bit universal bus transceiver containing D-type flip-flop, latch and transparent modes of operation for the data path. The device is uniquely partitioned as two 8-bit transceivers with individual latch timing and output control signals but with a common clock pin (CLK) for both transceiver words. Data flow for each word is determined by the respective latch enables (xLEAB and xLEBA), output enables (xOEAB and xOEBA) and clock (CLK). The output enables (1OEAB, 1OEBA, 2OEAB and 2OEBA) control Byte1 and Byte2 data for the A to B and B to A directions respectively.

For A-to-B data flow, the devices operate in the transparent mode when LEAB is HIGH. When LEAB transitions LOW, the A data is latched independent of CLK HIGH or LOW. If LEAB is LOW the A data is registered on the CLK LOW-to-HIGH transition. When OEAB is LOW the outputs are active. With OEAB HIGH the outputs are HIGH impedance. Data flow for the B-to-A direction is identical but uses OEBA, LEBA and CLK. Note that CLK is common to both directions and both 8-bit words. OE is also common and is used to disable all I/O ports simultaneously.

## Logic Diagrams

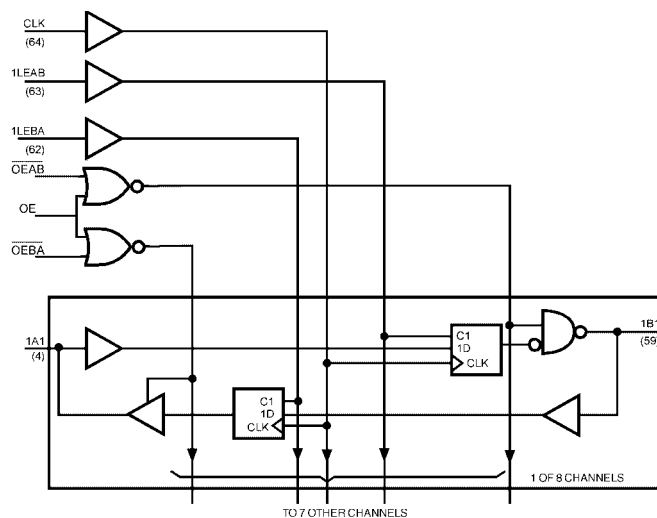
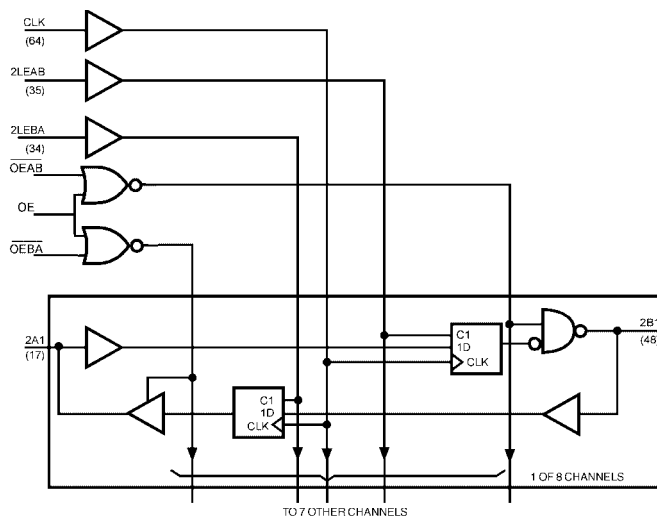

### Absolute Maximum Ratings (Note 5)

Supply Voltage ( $V_{CC}$ )	-0.5V to +4.6V
DC Input Voltage ( $V_I$ )	-0.5V to +4.6V
DC Output Voltage ( $V_O$ )	
Outputs 3-STATE	-0.5V to +4.6V
Outputs Active (Note 6)	-0.5V to + 4.6V
DC Output Sink Current into	
A Port $I_{OL}$	48 mA
DC Output Source Current from	
A Port $I_{OH}$	-48 mA
DC Output Sink Current into B Port in the LOW State, $I_{OL}$ (Note 7)	200 mA
DC Input Diode Current ( $I_{IK}$ )	
$V_I < 0V$	-50 mA
DC Output Diode Current ( $I_{OK}$ )	
$V_O < 0V$	-50 mA
$V_O > V_{CC}$	+50 mA
ESD Rating	>2000V
Storage Temperature ( $T_{STG}$ )	-65°C to +150°C

### Recommended Operating Conditions

Supply Voltage $V_{CC}$	3.0V to 3.6V
Bus Termination Voltage ( $V_{TT}$ )	
GTLP	1.35V to 1.65V
GTL	1.14V to 1.26V
$V_{REF}$	
GTLP	0.87V to 1.1V
GTL	0.74V to 0.87V
Input Voltage ( $V_I$ )	
on A Port and Control Pins	0.0V to $V_{CC}$
on B Port	0.0V to $V_{tt}$
HIGH Level Output Current ( $I_{OH}$ )	
A Port	-24 mA
LOW Level Output Current ( $I_{OL}$ )	
A Port	+24mA
B Port	+100 mA
Operating Temperature ( $T_A$ )	-40°C to +85°C

**Note 5:** The Absolute Maximum Ratings are those values beyond which the safety of the device cannot be guaranteed. The device should not be operated at these limits. The parametric values defined in the Electrical Characteristics tables are not guaranteed at the absolute maximum rating. The "Recommended Operating Conditions" table will define the conditions for actual device operation.

**Note 6:**  $I_O$  Absolute Maximum Rating must be observed.

**Note 7:**  $V_{TT}$  and  $R_{term}$  can be adjusted to accommodate backplane impedances other than 50Ω, within the boundaries of not exceeding the DC Absolute  $I_{OL}$  ratings (200 mA). Similarly  $V_{REF}$  can be adjusted to compensate for changes in  $V_{TT}$ .

### DC Electrical Characteristics

Over Recommended Operating Free-Air Temperature Range,  $V_{REF} = 1.0V$  (unless otherwise noted).

Symbol		Test Conditions		Min	Typ (Note 8)	Max	Units
$V_{IH}$	B Port			$V_{REF} + 0.05$		$V_{TT}$	V
	Others			2.0			V
$V_{IL}$	B Port			0.0		$V_{REF} - 0.05$	V
	Others					0.8	V
$V_{REF}$	GTLP			0.74	1.0	1.1	V
$V_{IK}$		$V_{CC} = 3.0V$	$I_I = -18 mA$			-1.2	V
$V_{OH}$	A Port	$V_{CC} = \text{Min to Max (Note 9)}$	$I_{OH} = -100 \mu A$	$V_{CC} - 0.2$			V
		$V_{CC} = 3.0V$	$I_{OH} = -12 mA$	2.4			
			$I_{OH} = -24 mA$	2.2			
$V_{OL}$	A Port	$V_{CC} = \text{Min to Max (Note 9)}$	$I_{OL} = 100 \mu A$			0.20	V
		$V_{CC} = 3.0V$	$I_{OL} = 12 mA$			0.40	
			$I_{OL} = 24 mA$			0.50	
	B Port	$V_{CC} = 3.0V$	$I_{OL} = 40 mA$			0.20	V
			$I_{OL} = 80 mA$			0.40	
			$I_{OL} = 100 mA$			0.50	
$I_I$	A Port	$V_{CC} = 3.6V$	$V_I = V_{CC}$ or 0V			±10	μA
	Control Pins	$V_{CC} = 3.6V$	$V_I = V_{CC}$ or 0V			±10	μA
	B Port	$V_{CC} = 3.6V$	$V_I = V_{TT}$ or GND			±10	μA
$I_{OFF}$	Except $V_{ERC}$	$V_{CC} = 0$	$V_I$ or $V_O = 0$ to $V_{CC}$			100	μA
$I_{I(\text{hold})}$	A Port	$V_{CC} = 3.0V$	$V_I = 0.8V$	75			μA
			$V_I = 2.0V$	-75			
		$V_{CC} = 3.6V$	$V_I = 0$ to $V_{CC}$			±500	

DC Electrical Characteristics (Continued)							
Symbol		Test Conditions		Min	Typ (Note 8)	Max	Units
I <sub>OZH</sub>	A Port	V <sub>CC</sub> = 3.6V	V <sub>O</sub> = V <sub>CC</sub>			10	μA
	B Port		V <sub>O</sub> = 1.5V			10	
I <sub>OZL</sub>	A Port	V <sub>CC</sub> = 3.6V	V <sub>O</sub> = 0V			-10	μA
	B Port		V <sub>O</sub> = 0.4V			-10	
I <sub>OZPU</sub> (Note 10)	A Port	V <sub>CC</sub> = 0 to 1.5V $\overline{OE} = 0$ or V <sub>CC</sub>	V <sub>O</sub> = 0.5 to 3V			±50	μA
I <sub>OZPD</sub> (Note 10)	A Port	V <sub>CC</sub> = 1.5 to 0V $\overline{OE} = 0$ or V <sub>CC</sub>	V <sub>O</sub> = 0.5 to 3V			±50	μA
I <sub>CC</sub> (V <sub>CC</sub> )	A or B Ports	V <sub>CC</sub> = 3.6 I <sub>O</sub> = 0 V <sub>I</sub> = V <sub>CC</sub> or GND	Outputs HIGH			55	mA
			Outputs LOW			55	
			Outputs Disabled			55	
ΔI <sub>CC</sub> (Note 11)	A Port and Control Pins	V <sub>CC</sub> = 3.6V A or Control Inputs at V <sub>CC</sub> or GND	One Input at V <sub>CC</sub> -0.6		0	1	mA
C <sub>i</sub>	Control Pins		V <sub>I</sub> = V <sub>CC</sub> or 0		5.8	7.0	pF
	A Port		V <sub>I</sub> = V <sub>CC</sub> or 0		8.0	9.5	
	B Port		V <sub>I</sub> = V <sub>CC</sub> or 0		8.3	9.9	
<p><b>Note 8:</b> All typical values are at V<sub>CC</sub> = 3.3V, and T<sub>A</sub> = 25°C.</p> <p><b>Note 9:</b> For conditions shown as Min or Max, use the appropriate value specified under recommended operating conditions.</p> <p><b>Note 10:</b> This is specified by characterization but not tested.</p> <p><b>Note 11:</b> This is the increase in supply current for each input that is at the specified TTL voltage level rather than V<sub>CC</sub> or GND.</p>							
<h3>Live Insertion Characteristics</h3> <p>Over Recommended Operating Free-Air Temperature Range, V<sub>REF</sub> = 1.0V (unless otherwise noted).</p>							
Parameter		Test Conditions		Min	Typ	Max	Units
I <sub>CC</sub> (V <sub>CC</sub> BIAS)	B Port	V <sub>CC</sub> = 0 to 3V	V <sub>O</sub> = 0 to 1.2V			5	mA
		V <sub>CC</sub> = 3.0 to 3.6V	V <sub>I</sub> (V <sub>CC</sub> BIAS) = 3 to 3.6V			10	
V <sub>O</sub>	B Port	V <sub>CC</sub> = 0    V <sub>I</sub> (V <sub>CC</sub> BIAS) = 3.3V			1.1		V
I <sub>O</sub>	B Port	V <sub>CC</sub> = 0    V <sub>I</sub> (V <sub>CC</sub> BIAS) = 3 to 3.6V    V <sub>O</sub> = 0.4		-1			μA
		V <sub>CC</sub> = 0 to 3.6V $\overline{OE} = 3.3V$				100	
		V <sub>CC</sub> = 0 to 1.5V $\overline{OE} = 0$ to 3.3V				100	
<h3>AC Operating Requirements (GTL16T1655)</h3> <p>Over recommended ranges of supply voltage and operating free-air temperature, V<sub>TT</sub> = 1.5V and V<sub>ref</sub> = 1.0V (unless otherwise noted).</p>							
Parameter				Min	Max	Unit	
f <sub>MAX</sub>	Maximum Clock Frequency			160		MHz	
t <sub>WIDTH</sub>	Pulse Duration		LE HIGH	3.0		ns	
			CLK HIGH or LOW	3.0			
t <sub>SU</sub>	Setup Time		Data before CLK↑	2.5		ns	
			Data before LE↓ (CLK = X)	2.5			
t <sub>HOLD</sub>	Hold Time		Data after CLK↑	0.5		ns	
			Data after LE↓ (CLK = X)	0.5			

### B to A AC Electrical Characteristics (GTL16T1655)

Over recommended range of supply voltage and operating free-air temperature,  $V_{REF} = 1.0V$ ,  $V_{TT} = 1.5V$ ,  $V_{ERC} = V_{CC}$  or GND (unless otherwise noted).  $C_L = 30$  pF for B Port and  $C_L = 50$  pF for A Port.

Parameter	From (Input)	To (Output)	Min	Typ (Note 12)	Max	Unit
$f_{MAX}$			160			MHz
$t_{PLH}$	B	A	1.0		4.7	ns
$t_{PHL}$			1.5		4.8	
$t_{PLH}$	LEAB	A	1.2		4.0	ns
$t_{PHL}$			1.2		3.8	
$t_{PLH}$	CLK	A	1.2		4.0	ns
$t_{PHL}$			1.2		4.0	
$t_{PLZ/HZ}$	$\overline{OE}$	A	1.4		4.5	ns
$t_{PZH/ZL}$			1.0		4.0	
$t_{PLZ/HZ}$	$\overline{OEBA}$	A	1.2		4.9	ns
$t_{PZH/ZL}$			1.0		4.0	

**Note 12:** All typical values are at  $V_{CC} = 3.3V$ , and  $T_A = 25^\circ C$ .

<b>A to B AC Electrical Characteristics (GTL16T1655)</b>						
Over recommended range of supply voltage and operating free air temperature, $V = 1.0V$ , $V_{TT} = 1.5V$ (unless otherwise noted). $C_L = 30$ pF for B Port and $C_L = 50$ pF for A Port.						
Symbol	From (Input)	To (Output)	Min	Type (Note 13)	Max	Units
$f_{MAX}$			160			MHz
$t_{PLH}$	A	B	2.6		5.7	ns
$t_{PHL}$	$V_{ERC} = V_{CC}$		0.8		4.5	
$t_{PLH}$	A	B	2.0		4.9	ns
$t_{PHL}$	$V_{ERC} = GND$		0.7		4.0	
$t_{PLH}$	LEAB	B	2.6		5.7	ns
$t_{PHL}$	$V_{ERC} = V_{CC}$		0.8		4.0	
$t_{PLH}$	LEAB	B	2.2		4.9	ns
$t_{PHL}$	$V_{ERC} = GND$		0.7		4.0	
$t_{PLH}$	CLK	B	2.8		5.7	ns
$t_{PHL}$	$V_{ERC} = V_{CC}$		1.0		4.0	
$t_{PLH}$	CLK	B	2.3		5.0	ns
$t_{PHL}$	$V_{ERC} = GND$		0.8		4.0	
$t_{PLH}$	$\overline{OE}$	B	2.7		5.8	ns
$t_{PHL}$	$V_{ERC} = V_{CC}$		0.6		4.0	
$t_{PLH}$	$\overline{OE}$	B	2.1		4.9	ns
$t_{PHL}$	$V_{ERC} = GND$		1.0		4.0	
$t_{PLH}$	$\overline{OEAB}$	B	2.6		5.8	ns
$t_{PHL}$	$V_{ERC} = V_{CC}$		0.6		4.0	
$t_{PLH}$	$\overline{OEAB}$	B	2.0		4.9	ns
$t_{PHL}$	$V_{ERC} = GND$		0.6		3.5	
$t_{FALL/RISE}$ $V_{ERC} = V_{CC}$	Transition Time, B outputs (0.6V to 1.3V)		0.7/0.7	2.0/2.5		ns
$t_{FALL/RISE}$ $V_{ERC} = GND$	Transition Time, B outputs (0.6V to 1.3V)		0.7/0.7	1.5/2.0		ns
<b>Note 13:</b> All Typical values are at $V_{CC} = 3.3V$ and $T_A = 25^\circ C$						

### Extended Electrical Characteristics (GTLP)

Over recommended ranges of supply voltage and operating free-air temperature  $V_{REF} = 1.0V$  (unless otherwise noted).  
 $C_L = 30$  pF for B Port and  $C_L = 50$  pF for A Port.

Symbol	From (Input)	To (Output)	Min	Typ (Note 14)	Max	Unit
$t_{OSLH}$ (Note 15)	A	B		0.4	1.0	ns
$t_{OSHL}$ (Note 15)				0.4	1.0	ns
$t_{PV(HL)}$ (Note 16) (Note 17)	A	B			1.5	ns
$t_{OSLH}$ (Note 15)	CLKAB	B		0.3	0.9	ns
$t_{OSHL}$ (Note 15)				0.3	0.6	ns
$t_{PV(HL)}$ (Note 16)(Note 17)	CLKAB	B			1.2	ns
$t_{OSLH}$ (Note 15)	B	A		0.3	1.0	ns
$t_{OSHL}$ (Note 15)				0.3	1.0	ns
$t_{OST}$ (Note 15)	B	A		0.6	1.5	ns
$t_{PV}$ (Note 16)	B	A			1.6	ns
$t_{OSLH}$ (Note 15)	CLKAB	A		0.3	0.6	ns
$t_{OSHL}$ (Note 15)				0.3	0.6	ns
$t_{OST}$ (Note 15)	CLKAB	A		0.5	1.0	ns
$t_{PV}$ (Note 16)	CLKAB	A			1.1	ns

**Note 14:** All typical values are at  $V_{CC} = 3.3V$ , and  $T_A = 25^{\circ}C$ .

**Note 15:**  $t_{OSHL}/t_{OSLH}$  and  $t_{OST}$ —Output to output skew is defined as the absolute value of the difference between the actual propagation delay for all outputs within the same packaged device. The specifications are given for specific worst case  $V_{CC}$  and temperature and apply to any outputs switching in the same direction either HIGH-to-LOW ( $t_{OSHL}$ ) or LOW-to-HIGH ( $t_{OSLH}$ ) or in opposite directions both HL and LH ( $t_{OST}$ ). This parameter is guaranteed by design and statistical process distribution. Actual skew values between the GTLP outputs could vary on the backplane due to the loading and impedance seen by the device.

**Note 16:**  $t_{PV}$ —Part to part skew is defined as the absolute value of the difference between the actual propagation delay for all outputs from device to device. The parameter is specified for a specific worst case  $V_{CC}$  and temperature. This parameter is guaranteed by design and statistical process distribution. Actual skew values between the GTLP outputs could vary on the backplane due to the loading and impedance seen by the device.

**Note 17:** Due to the open drain structure on GTLP outputs,  $t_{OST}$  and  $t_{PV(LH)}$  in the A-to-B direction are not specified. Skew on these paths is dependent on the  $V_{TT}$  and  $R_T$  values on the backplane.

<b>AC Operating Requirements (GTL)</b>					
Over recommended ranges of supply voltage and operating free-air temperature, $V_{TT} = 1.2V$ and $V_{ref} = 0.8V$ (unless otherwise noted).					
Parameter			Min	Max	Units
$f_{MAX}$	Maximum Clock Frequency		160		MHz
$t_{WIDTH}$	Pulse Duration	LE HIGH	3.0		ns
		CLK HIGH or LOW	3.0		ns
$t_{SU}$	Setup Time	Data before CLK $\uparrow$	2.5		ns
		Data before LE $\downarrow$ (CLK = X)	2.5		
$t_{HOLD}$	Hold Time	Data after CLK $\uparrow$	0.5		ns
		Data after LE $\downarrow$ (CLK = X)	0.5		

<b>B to A AC Electrical Characteristics (GTL)</b>						
Over recommended range of supply voltage and operating free air temperature, $V_{ref} = 0.8V$ , $V_{TT} = 1.2V$ , $V_{ERC} = V_{CC}$ or GND (unless otherwise noted). $C_L = 30pF$ for B Port and $C_L = 50 pF$ for A Port.						
Parameter	From (Input)	To (Output)	Min	Typ (Note 18)	Max	Units
$f_{MAX}$			160			MHz
$t_{PLH}$	B	A	1.0		4.7	ns
$t_{PHL}$			1.2		4.8	
$t_{PLH}$	LEBA	A	1.0		4.4	ns
$t_{PHL}$			1.1		4.0	
$t_{PLH}$	CLK	A	1.0		4.2	ns
$t_{PHL}$			1.1		4.1	
$t_{PLZ/HZ}$	$\overline{OE}$	A	1.5		4.6	ns
$t_{PZH/ZL}$			1.2		4.2	
$t_{PLZ/HZ}$	$\overline{OEBA}$	A	1.2		4.9	ns
$t_{PZH/ZL}$			1.0		4.0	

**Note 18:** All Typical values are at  $V_{CC} = 3.3V$  and  $T_A = 25^\circ C$ .

### A to B AC Electrical Characteristics (GTL)

Over recommended range of supply voltage and operating free air temperature,  $V_{REF} = 0.8V$ ,  $V_{TT} = 1.2V$  (unless otherwise noted).  
 $C_L = 30$  pF for B Port and  $C_L = 50$  pF for A Port.

Symbol	From (Input)	To (Output)	Min	Typ (Note 19)	Max	Units
$f_{MAX}$			160			MHz
$t_{PLH}$	A	B	2.2		5.7	ns
$t_{PHL}$	$V_{ERC} = V_{CC}$		1.0		4.7	
$t_{PLH}$	A	B	1.5		4.8	ns
$t_{PHL}$	$V_{ERC} = GND$		0.9		4.0	
$t_{PLH}$	LEAB	B	2.2		5.7	ns
$t_{PHL}$	$V_{ERC} = V_{CC}$		1.0		4.1	
$t_{PLH}$	LEAB	B	1.7		5.0	ns
$t_{PHL}$	$V_{ERC} = GND$		0.9		4.4	
$t_{PLH}$	CLK	B	2.8		5.8	ns
$t_{PHL}$	$V_{ERC} = V_{CC}$		1.0		4.3	
$t_{PLH}$	CLK	B	2.3		5.0	ns
$t_{PHL}$	$V_{ERC} = GND$		1.0		4.3	
$t_{PLH}$	$\overline{OE}$	B	2.5		5.8	ns
$t_{PHL}$	$V_{ERC} = V_{CC}$		0.8		4.3	
$t_{PLH}$	$\overline{OE}$	B	1.7		4.9	ns
$t_{PHL}$	$V_{ERC} = GND$		0.9		4.3	
$t_{PLH}$	$\overline{OEAB}$	B	2.2		5.8	ns
$t_{PHL}$	$V_{ERC} = V_{CC}$		0.8		4.3	
$t_{PLH}$	$\overline{OEAB}$	B	1.7		4.9	ns
$t_{PHL}$	$V_{ERC} = GND$		0.9		3.8	
$t_{FALL/RISE}$ $V_{ERC} = V_{CC}$	Transition Time, B outputs (0.6V to 1.3V)		0.7/0.7	2.0/2.5		ns
$t_{FALL/RISE}$ $V_{ERC} = V_{CC}$	Transition Time, B outputs (0.6V to 1.3V)		0.7/0.7	1.5/2.0		ns

**Note 19:** All Typical values are at  $V_{CC} = 3.3V$  and  $T_A = 25^\circ C$ .

### Extended Electrical Characteristics (GTL)

Over recommended ranges of supply voltage and operating free-air temperature  $V_{REF} = 0.8V$  (unless otherwise noted).  
 $C_L = 30$  pF for B Port and  $C_L = 50$  pF for A Port.

Symbol	From (Input)	To (Output)	Min	Typ (Note 20)	Max	Unit
$t_{OSLH}$ (Note 21)	A	B		0.4	1.0	ns
$t_{OSHL}$ (Note 21)				0.4	1.0	ns
$t_{PV(HL)}$ (Note 22) (Note 23)	A	B			1.5	ns
$t_{OSLH}$ (Note 21)	CLKAB	B		0.3	0.9	ns
$t_{OSHL}$ (Note 21)				0.3	0.6	ns
$t_{PV(HL)}$ (Note 22)(Note 23)	CLKAB	B			1.2	ns
$t_{OSLH}$ (Note 21)	B	A		0.3	1.0	ns
$t_{OSHL}$ (Note 21)				0.3	1.0	ns
$t_{OST}$ (Note 21)	B	A		0.6	1.5	ns
$t_{PV}$ (Note 22)	B	A			1.6	ns
$t_{OSLH}$ (Note 21)	CLKAB	A		0.3	0.6	ns
$t_{OSHL}$ (Note 21)				0.3	0.6	ns
$t_{OST}$ (Note 21)	CLKAB	A		0.5	1.0	ns
$t_{PV}$ (Note 22)	CLKAB	A			1.1	ns

**Note 20:** All typical values are at  $V_{CC} = 3.3V$ , and  $T_A = 25^\circ C$ .

**Note 21:**  $t_{OSHL}/t_{OSLH}$  and  $t_{OST}$ —Output to output skew is defined as the absolute value of the difference between the actual propagation delay for all outputs within the same packaged device. The specifications are given for specific worst case  $V_{CC}$  and temperature and apply to any outputs switching in the same direction either HIGH-to-LOW ( $t_{OSHL}$ ) or LOW-to-HIGH ( $t_{OSLH}$ ) or in opposite directions both HL and LH ( $t_{OST}$ ). This parameter is guaranteed by design and statistical process distribution. Actual skew values between the GTL outputs could vary on the backplane due to the loading and impedance seen by the device.

**Note 22:**  $t_{PV}$ —Part to part skew is defined as the absolute value of the difference between the actual propagation delay for all outputs from device to device. The parameter is specified for a specific worst case  $V_{CC}$  and temperature. This parameter is guaranteed by design and statistical process distribution. Actual skew values between the GTL outputs could vary on the backplane due to the loading and impedance seen by the device.

**Note 23:** Due to the open drain structure on GTL outputs,  $t_{OST}$  and  $t_{PV(LH)}$  in the A-to-B direction are not specified. Skew on these paths is dependent on the  $V_{TT}$  and  $R_T$  values on the backplane.

## Test Circuits and Timing Waveforms

**Test Circuit for A Outputs**

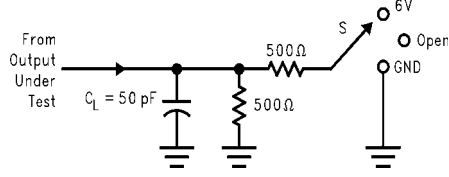

Test	S
$t_{PLH}/t_{PHL}$	Open
$t_{PLZ}/t_{PZL}$	6V
$t_{PHZ}/t_{PZH}$	GND

**Test Circuit for B Outputs**

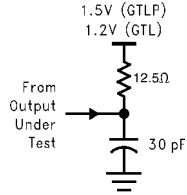

**Note A:**  $C_L$  includes probes and Jig capacitance.  
**Note B:** For B Port,  $C_L = 30$  pF is used for worst case.

**Voltage Waveform - Propagation Delay Times**

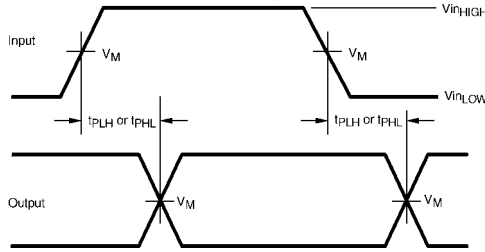

**Voltage Waveform - Setup and Hold Times**

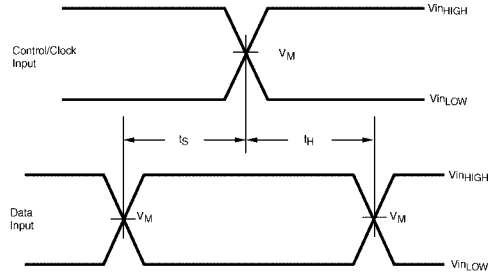

**Voltage Waveform - Pulse Width**

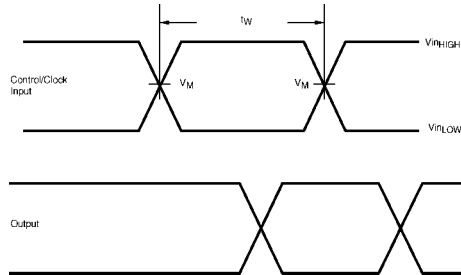

**Voltage Waveform - Enable and Disable Times**

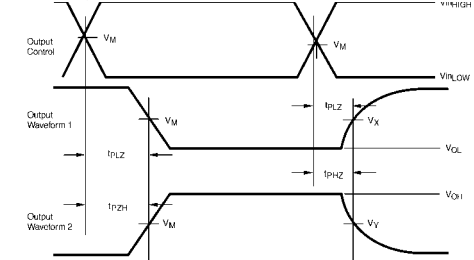

Output Waveform 1 is for an output with internal conditions such that the output is LOW except when disabled by the control output  
 Output Waveform 2 is for an output with internal conditions such that the output is HIGH except when disabled by the control output

**Input and Measure Conditions**

	A or LVTTTL Pins	B or GTLP Pins
$V_{inHIGH}$	3.0	1.5
$V_{inLOW}$	0.0	0.0
$V_M$	1.5	1.0
$V_X$	$V_{OL} + 0.3V$	N/A
$V_Y$	$V_{OH} - 0.3V$	N/A

All input pulses have the following characteristics: Frequency = 10MHz,  $t_{RISE} = t_{FALL} = 2$  ns,  $Z_O = 50\Omega$   
 The outputs are measured one at a time with one transition per measurement

**Physical Dimensions** inches (millimeters) unless otherwise noted

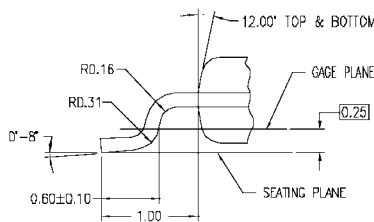
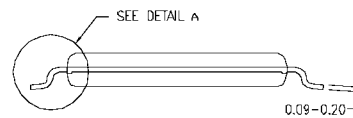
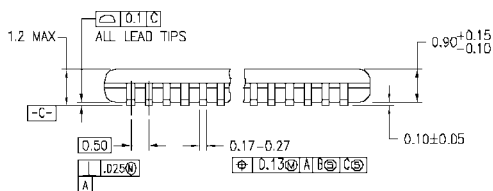
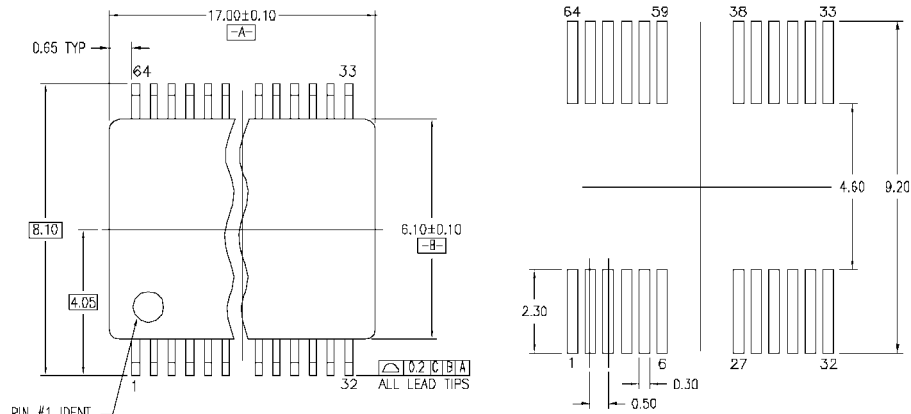

**NOTES:**

- A. CONFORMS TO JEDEC REGISTRATION MO-153, VARIATION EF, REF NOTE B, DATE 7/93.
- B. DIMENSIONS ARE IN MILLIMETERS.
- C. DIMENSIONS ARE EXCLUSIVE OF BURRS, MOLD FLASH, AND TIE BAR EXTRUSIONS.
- D. DIMENSIONS AND TOLERANCES PER ANSI Y14.5M, 1982.

MTD64REV B

**64-Lead Thin Shrink Small Outline Package (TSSOP), JEDEC MO-153, 6.1mm Wide Package Number MTD64**

Fairchild does not assume any responsibility for use of any circuitry described, no circuit patent licenses are implied and Fairchild reserves the right at any time without notice to change said circuitry and specifications.

**LIFE SUPPORT POLICY**



FAIRCHILD'S PRODUCTS ARE NOT AUTHORIZED FOR USE AS CRITICAL COMPONENTS IN LIFE SUPPORT DEVICES OR SYSTEMS WITHOUT THE EXPRESS WRITTEN APPROVAL OF THE PRESIDENT OF FAIRCHILD SEMICONDUCTOR CORPORATION. As used herein:

1. Life support devices or systems are devices or systems which, (a) are intended for surgical implant into the body, or (b) support or sustain life, and (c) whose failure to perform when properly used in accordance with instructions for use provided in the labeling, can be reasonably expected to result in a significant injury to the user.
2. A critical component in any component of a life support device or system whose failure to perform can be reasonably expected to cause the failure of the life support device or system, or to affect its safety or effectiveness.

[www.fairchildsemi.com](http://www.fairchildsemi.com)

## Looking for pricing, stock, or lifecycle information?

Click below to explore more details on WIN SOURCE:

-  [View GTLP16T1655MTDX on WIN SOURCE](#)
-  [Fairchild/ON Semiconductor](#) Information

## Optimize Your Supply Chain with WIN SOURCE Solutions

-  Global Sourcing Solution
-  Obsolete Management
-  Cost Control Management
-  Shortage Management
-  Alternative Solution
-  Excess Inventory Management