

GP2W1001YP

Low Profile Type IrDA Transceiver Module Compliant with IrDA1.1

■ Features

1. Integrated package of light emitter and receiver.
(10.0×4.4×H3.5 mm)
2. Low profile type (Height:3.5 mm)
3. Compliant with IrDA1.0 and IrDA1.1
4. Low voltage operation type
(Supply voltage:2.4V to 5.5V)
5. Low dissipation current thanks to power down mode
(Dissipation current at shut-down mode:Max. 1μA)
6. Applicable for reflow soldering
7. With shield case

■ Applications

1. Personal computers
2. Personal information tools

■ Absolute Maximum Ratings (Ta=25°C)

Parameter	Symbol	Rating	Unit
Supply voltage	V _{CC}	6	V
Transmission signal duty ratio	TXduty	50	%
Operating temperature	T _{opr}	-10 to +70	°C
Storage temperature	T _{stg}	-20 to +85	°C

Note) Transmission signal duty ratio show the time share of H level of transmission wave at TX terminal. The frequency shall be 1kHz or more.

■ Outline Dimensions

(Unit : mm)

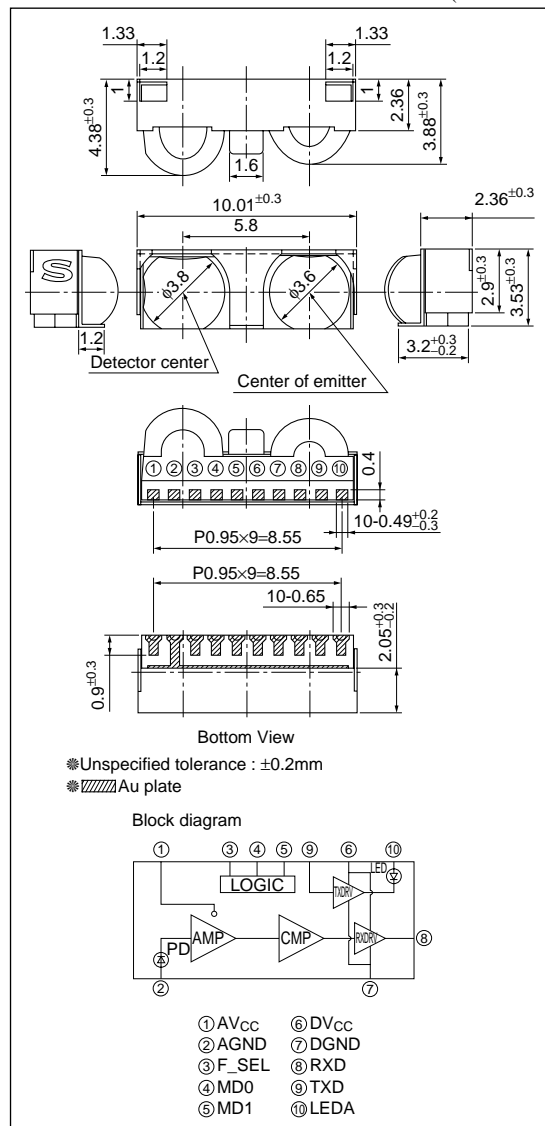

■ Recommended Operating Conditions (Ta=25°C)

Parameter	Symbol	Rating	Unit
Operating Supply voltage	V _{CC}	2.7 to 5.5	V
Operating temperature	T _{opr}	0 to +70	°C
SIR bit rate	–	9.6 to 115.2	kbps
FIR bit rate	–	1.152/4	Mbps

■ Electro-optical Characteristics (Ta=25±3°C, V_{CC}=3.3±0.1V, 5±0.1V, Ambient illuminance of detecting face: 100lx or less)

Parameter		Symbol	Conditions	MIN.	TYP.	MAX.	Unit
Receiver side	Dissipation current at no input signal	I _{CC}	RXOUT:H, TXIN:L, V _{CC} =3.3V	–	–	1.2	mA
			RXOUT:H, TXIN:L, V _{CC} =5.0V	–	–	1.5	mA
	S/D dissipation current	I _{CCS}	RXOUT:H, TXIN:L, V _{CC} =3.3V	–	0.1	1	μA
			RXOUT:H, TXIN:L, V _{CC} =5.0V	–	0.2	2	μA
	Dissipation current	I _{CCP}	Peak Value, V _{CC} =3.3V (2.4Ω), 5.0V (6.8Ω)	–	400	600	mA
	Switching time (Shut down to stand by)	trSD		–	–	1.5	ms
	Receiver sensitivity (–15°≤θ≤+15°)	S _{rxθ}	SIR:9.6k to 115.2kbps	0.04	–	5 000	W/m ²
			FIR:1.152M/4Mbps	0.01	–	5 000	W/m ²
	Low level output voltage	V _{OL}	V _{CC} =3.3, 5.0V	–	–	0.4	V
	High level output voltage	V _{OH}	V _{CC} =3.3, 5.0V	V _{CC} -0.4	–	–	V
	Rise time	t _{rrA}	SIR:9.6k to 115.2kbps	–	–	200	ns
		t _{rrB}	FIR:1.152M/4Mbps	–	–	40	ns
	Fall time	t _{frA}	SIR:9.6k to 115.2kbps	–	–	200	ns
		t _{frB}	FIR:1.152M/4Mbps	–	–	40	ns
	Peak sensitivity wavelength	λ _{ex}		–	940	–	nm
	Low level pules width		t _{w1}	SIR:Pulse width 19.53μs(9.6kbps), Duty 3/16	1	–	22
t _{w2}			SIR:Pulse width 1.63μs(115.2kHz), Duty 3/16	1	–	3	μs
t _{w3}			FIR:Pulse width 217ns(1.152Mbps), Duty 1/4	110	–	500	ns
t _{w4}			FIR:Pules width Single 125ns(4Mbps), Duty 1/4	85	–	165	ns
t _{w5}			FIR:Pules width Double 250ns(4Mbps), Duty 1/4	210	–	290	ns
Peak emission wavelength	λ _{ex}		850	880	900	nm	
Transmitter side	Radiant intensity	φ=0°	Low Power	–	15	–	mW/sr
		φ=0°	Middle Power	–	60	–	mW/sr
		–15°≤φ≤+15°	Full Power	100	–	500	mW/sr
	Low level input voltage	V _{IL}	V _{CC} =3.3, 5.0V	–	–	V _{CC} ×0.2	V
	High level input voltage	V _{IH}	V _{CC} =3.3, 5.0V	V _{CC} ×0.2	–	–	V
	TXin terminal input current	I _{IH}	TXIN=V _{CC} =5.0V	–	–	50	μA
I _{IL}		TXIN=GND	–0.1	0	0.1	μA	
Transmission signal rise time	t _{rx}		–	–	40	ns	
Transmission signal fall time	t _{fx}		–	–	40	ns	

■ Truth Table

Input		Output	
TXD (Transmitter)	*1 Receiver	State of LED (Transmitter)	RXD terminal
High	–	ON	X
Low	ON	OFF	Low
Low	OFF	OFF	High

X:Do not care

*1 External optical signal receiving state of photodiode

■ Input Output Logic Table

MD0	MD1	F_SEL	TXD	RXD terminal mode	TXO *2	Remarks
1	0	X	0	Shut down	Shut down	—
	0	1	0	RXA	X	Latch TXD *1
	0	1	1	RXB	X	Latch TXD *1
0	0	0	X	RXA	HPW	TXO Output High Power mode
0	1	0	X	↓	MPW	TXO Output Middle Power mode
1	1	0	X	↓	LPW	TXO Output Low Power mode
0	0	1	X	RXB	HPW	TXO Output High Power mode
0	1	1	X	↓	MPW	TXO Output Middle Power mode
1	1	1	X	↓	LPW	TXO Output Low Power mode

*1 F_SEL → 0:reset latching state of TXD, and turn to RXA channel.
 RXA:RXA channel mode:115kbps or less (SIR 115.2kbps, 9 600bps)
 RXB:RXB channel mode:115kbps or more (FIR 1.152Mbps, 4Mbps)
 *2 LED operating mode

Fig.1 Recommended External Circuit

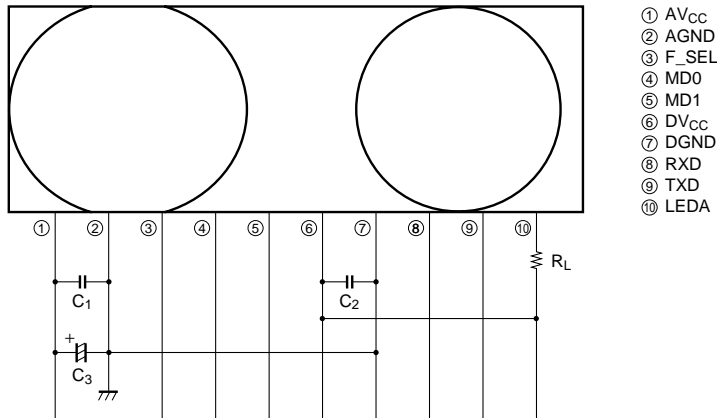

Components	Recommended values
C1•C2	1μF±10% (Note 1)
C3	4.7μF±10% (Note 2)
RL	2.4Ω±5% 1/2W (VCC=3.3V)
	6.8Ω±5% 1/2W (VCC=5V)

(Note 1) Please locate nearby this transceiver choosing the ceramic capacitor with higher frequency feature

(Note 2) Please choose the most suitable CX according to the noise level and noise frequency of power supply

Fig.2 Output Waveform Specification(Receiver side)(CL≤10pF)

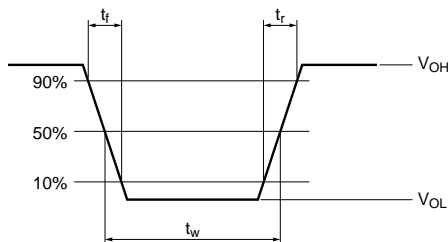
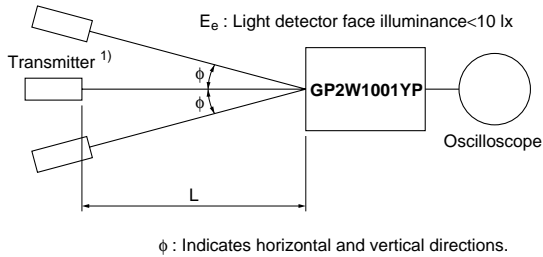

Fig.3 Standard Optical System(Receiver side)



Transfer rate	T_1	T_2	T_2/T_1	Radiant intensity
9.6kbps	104 μ s	19.53 μ s	3/16	40mW/sr
115.2kbps	8.68 μ s	1.63 μ s	3/16	40mW/sr
1.152Mbps	868ns	217ns	1/4	100mW/sr
4Mbps (S)	500ns	125ns	1/4	100mW/sr
4Mbps (W)	1 000ns	250ns	1/4	100mW/sr

The light emitting diode (SHARP GL710, $\lambda_p=850$ to 900nm) is used as the transmitter, where the following continuous signals are transmitted.
 In Fig.3, output signal shall be complete receiver side electro-optical characteristics.

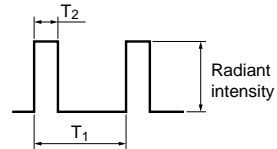

Fig.4 Output Waveform Specification(Transmitter side)

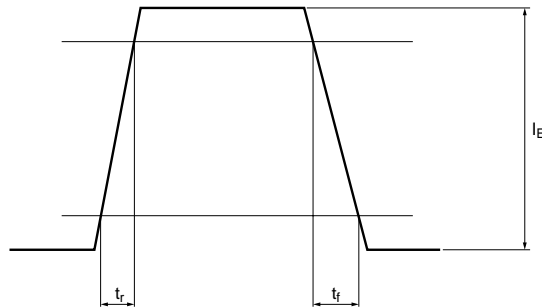

Fig.5 Standard Optical System(Transmitter side)

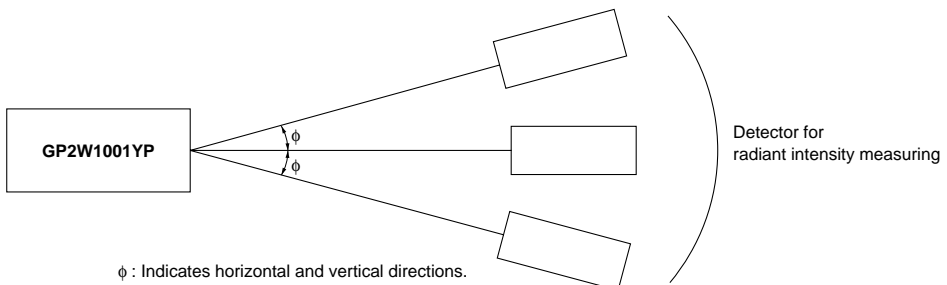

Fig.6 Recommended Circuit of Transmitter side

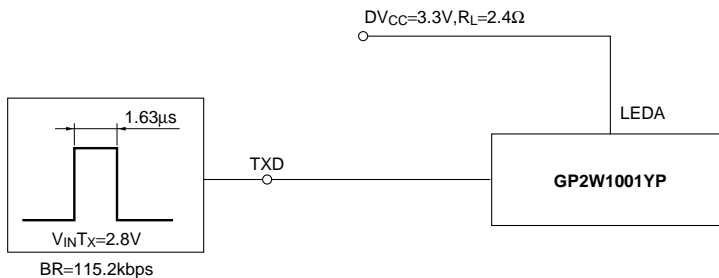

Fig.7 Peak Forward Current vs. Ambient Temperature

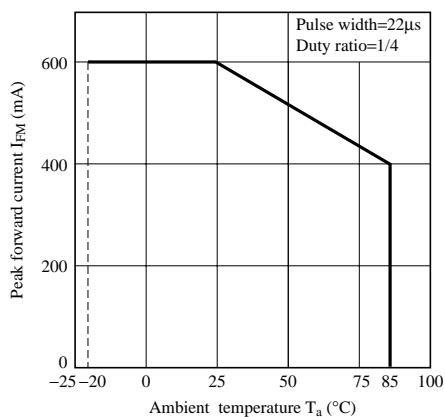

Fig.8 Recommended PCB Foot Pattern

Dimensions are shown for reference

(unit : mm)

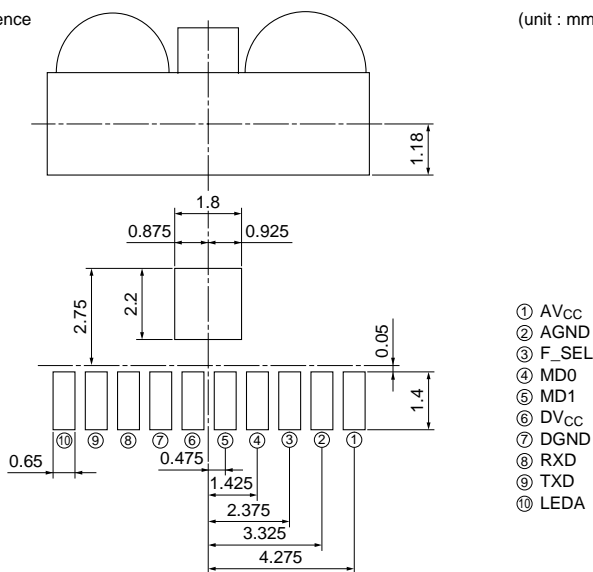
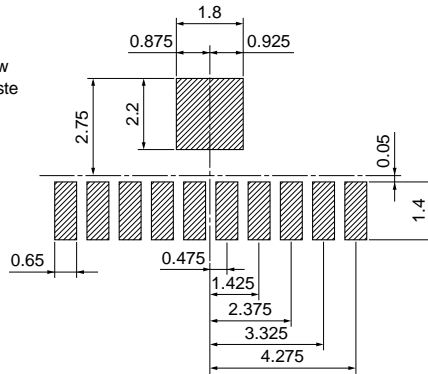

Fig.9 Recommended Size of Solder Creamed Paste (Reference)

Dimensions are shown for reference.
Please open the solder mask as below
so that the size of solder creamed paste
for this device before reflow soldering
must be as large as one of the foot
pattern land indicated at Fig.8

(unit : mm)



▨ : Solder paste area

NOTICE





- The circuit application examples in this publication are provided to explain representative applications of SHARP devices and are not intended to guarantee any circuit design or license any intellectual property rights. SHARP takes no responsibility for any problems related to any intellectual property right of a third party resulting from the use of SHARP's devices.
- Contact SHARP in order to obtain the latest device specification sheets before using any SHARP device. SHARP reserves the right to make changes in the specifications, characteristics, data, materials, structure, and other contents described herein at any time without notice in order to improve design or reliability. Manufacturing locations are also subject to change without notice.
- Observe the following points when using any devices in this publication. SHARP takes no responsibility for damage caused by improper use of the devices which does not meet the conditions and absolute maximum ratings to be used specified in the relevant specification sheet nor meet the following conditions:
 - (i) The devices in this publication are designed for use in general electronic equipment designs such as:
 - Personal computers
 - Office automation equipment
 - Telecommunication equipment [terminal]
 - Test and measurement equipment
 - Industrial control
 - Audio visual equipment
 - Consumer electronics
 - (ii) Measures such as fail-safe function and redundant design should be taken to ensure reliability and safety when SHARP devices are used for or in connection with equipment that requires higher reliability such as:
 - Transportation control and safety equipment (i.e., aircraft, trains, automobiles, etc.)
 - Traffic signals
 - Gas leakage sensor breakers
 - Alarm equipment
 - Various safety devices, etc.
 - (iii) SHARP devices shall not be used for or in connection with equipment that requires an extremely high level of reliability and safety such as:
 - Space applications
 - Telecommunication equipment [trunk lines]
 - Nuclear power control equipment
 - Medical and other life support equipment (e.g., scuba).
- Contact a SHARP representative in advance when intending to use SHARP devices for any "specific" applications other than those recommended by SHARP or when it is unclear which category mentioned above controls the intended use.
- If the SHARP devices listed in this publication fall within the scope of strategic products described in the Foreign Exchange and Foreign Trade Control Law of Japan, it is necessary to obtain approval to export such SHARP devices.
- This publication is the proprietary product of SHARP and is copyrighted, with all rights reserved. Under the copyright laws, no part of this publication may be reproduced or transmitted in any form or by any means, electronic or mechanical, for any purpose, in whole or in part, without the express written permission of SHARP. Express written permission is also required before any use of this publication may be made by a third party.
- Contact and consult with a SHARP representative if there are any questions about the contents of this publication.

Looking for pricing, stock, or lifecycle information?

Click below to explore more details on WIN SOURCE:

-  [View GP2W1001YP on WIN SOURCE](#)
-  [Sharp Microelectronics](#) Information

Optimize Your Supply Chain with WIN SOURCE Solutions

-  Global Sourcing Solution
-  Obsolete Management
-  Cost Control Management
-  Shortage Management
-  Alternative Solution
-  Excess Inventory Management