



**THE DATASHEET OF  
TGA3042-SMTR7**



### Product Description

Qorvo’s TGA3042-SM is a packaged high power MMIC amplifier fabricated on Qorvo’s production 0.15um GaN on SiC process (QGaN15). The TGA3042-SM operates from 7 – 10.5 GHz and typically provides 4.5 W saturated output power with power-added efficiency of 38.5% and large-signal gain of 23.5 dB. This combination of wideband performance provides the flexibility designers are looking for to improve system performance while reducing size and cost.

The TGA3042-SM is matched to 50Ω with integrated DC blocking capacitors on both RF I/O ports simplifying system integration. The wideband performance makes it ideally suited in support of multiple radar and communication bands.

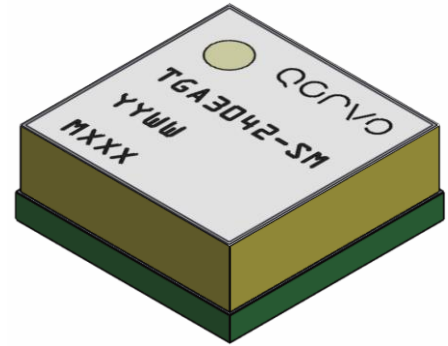

### Functional Block Diagram

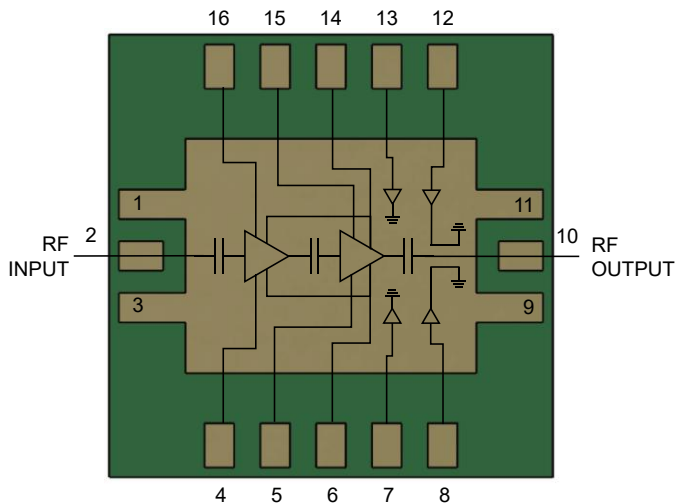

### Applications

- Radar
- Communications

### Product Features

- Frequency Range: 7 – 10.5 GHz
- P<sub>OUT</sub>: 36.5 dBm at P<sub>IN</sub> = 13 dBm
- PAE: 38.5 % at P<sub>IN</sub> = 13 dBm
- Large Signal Gain: 23.5 dB at P<sub>IN</sub> = 13 dBm
- Small Signal Gain: 32 dB
- Bias: V<sub>D</sub> = 20 V, I<sub>DQ</sub> = 200 mA
- Package Dimensions: 4.50 x 4.50 x 1.74 mm

*Performance is typical across frequency. Please reference electrical specification table and data plots for more details.*

### Ordering Information

Part No.	Description
TGA3042-SM	7 – 10.5 GHz 4.5 W GaN Power Amplifier
TGA3042-SMPCB4B01	Evaluation Board

### Absolute Maximum Ratings

Parameter	Value / Range
Drain Voltage ( $V_D$ )	29.5 V
Gate Voltage Range ( $V_G$ )	-8 to 0 V
Drain Current ( $I_D$ )	720 mA
Gate Current ( $I_G$ )	See chart pg. 13
Power Dissipation ( $P_{DISS}$ ), 85°C	15.4 W
Input Power ( $P_{IN}$ ), CW, 50Ω, $V_D=20$ V, $I_{DQ}=200$ mA, 85 °C	23 dBm
Input Power ( $P_{IN}$ ), CW, VSWR 3:1, $V_D=20$ V, $I_{DQ}=200$ mA 85 °C	23 dBm
Mounting Temperature (30 Seconds)	260 °C
Storage Temperature	-55 to 150 °C

Operation of this device outside the parameter ranges given above may cause permanent damage. These are stress ratings only, and functional operation of the device at these conditions is not implied.

### Recommended Operating Conditions

Parameter	Value / Range
Drain Voltage ( $V_D$ )	20 V
Drain Current ( $I_{DQ}$ )	200 mA
Gate Voltage Range ( $V_G$ )	-2.8 to -2.0 V

Electrical specifications are measured at specified test conditions. Specifications are not guaranteed over all recommended operating conditions.

### Electrical Specifications

Parameter		Min	Typ	Max	Units
Operational Frequency Range		7		10.5	GHz
Output Power ( $P_{in} = 13$ dBm)	7.0 GHz	35.0	36.3		dBm
	9.0 GHz	35.0	36.5		dBm
	10.5 GHz	34.5	35.9		dBm
Power Added Efficiency ( $P_{in} = 13$ dBm)	7.0 GHz	30.0	41.1		%
	9.0 GHz	30.0	38.9		%
	10.5 GHz	28.0	37.8		%
3 <sup>rd</sup> Order Intermodulation Level ( $P_{OUT}/Tone = 26$ dBm)	7.0 GHz		-23.2		dBc
	9.0 GHz		-24.7		dBc
	10.5 GHz		-23.4		dBc
Small Signal Gain	7.0 GHz		33.3		dB
	9.0 GHz		32.9		dB
	10.5 GHz		30.6		dB
Input Return Loss	7.0 GHz		12		dB
	9.0 GHz		15		dB
	10.5 GHz		18		dB
Output Return Loss	7.0 GHz		9		dB
	9.0 GHz		13		dB
	10.5 GHz		10		dB
Output Power Temperature Coefficient (25 – 85 °C)			-0.006		dB/°C
Sm. Signal Gain Temperature Coefficient			-0.059		dB/°C

Test conditions unless otherwise noted: 25 °C,  $V_D = 20$ ,  $I_{DQ} = 200$  mA

### Performance Plots – Large Signal (CW)

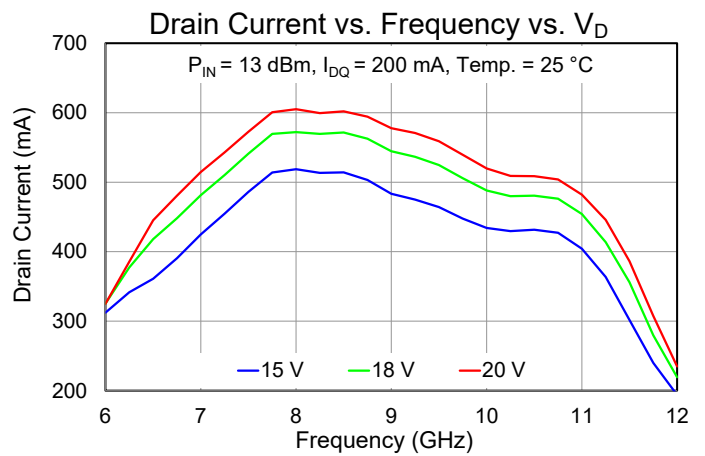
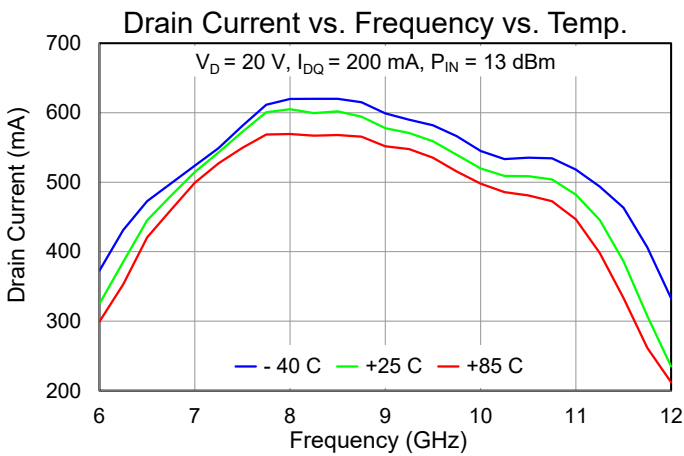
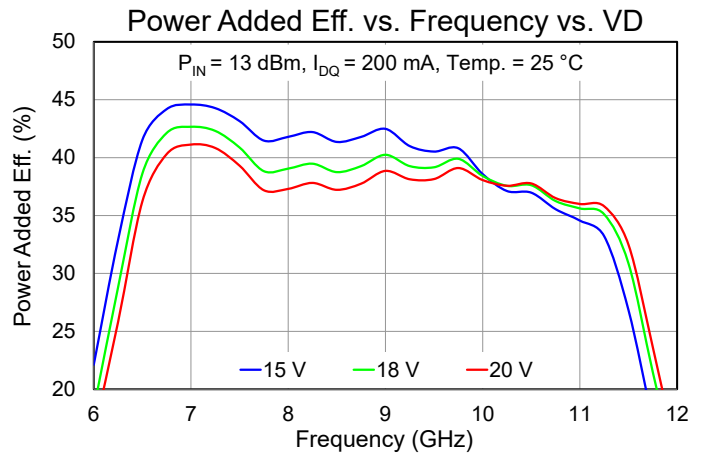
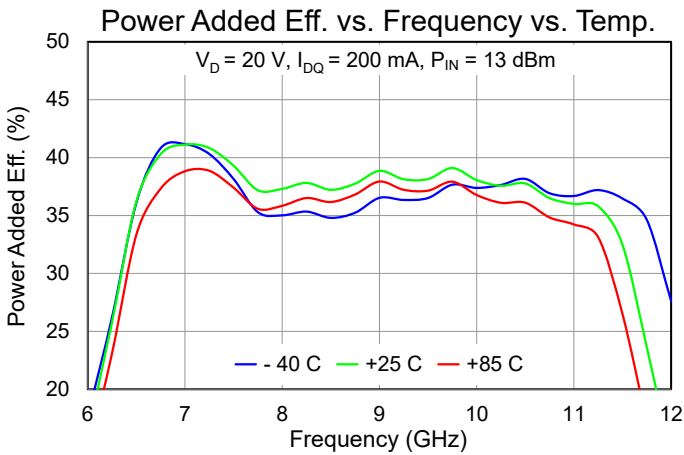
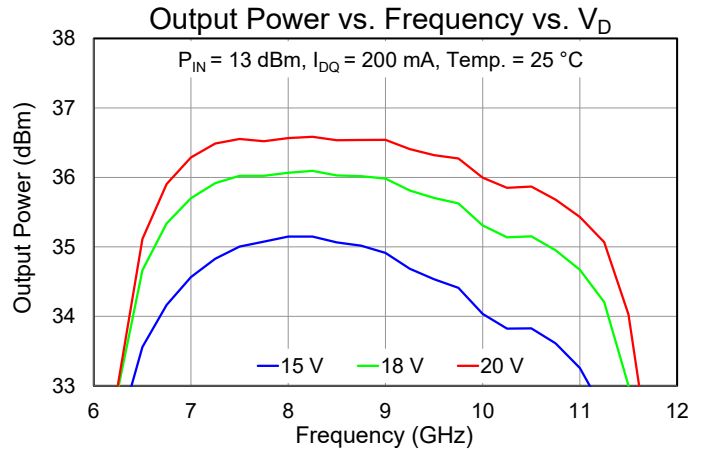
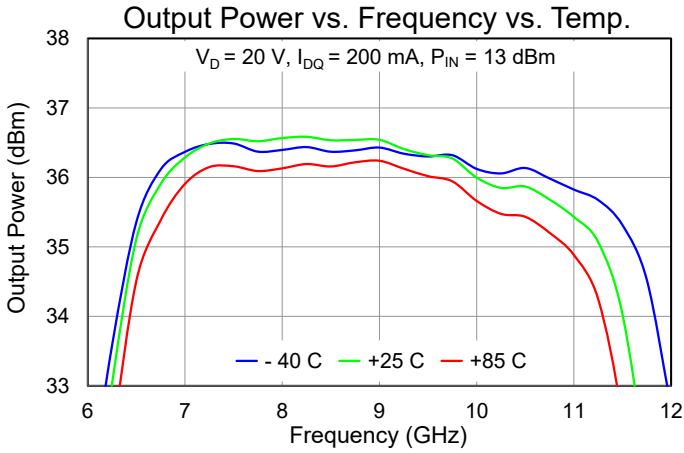

### Performance Plots – Large Signal (CW)

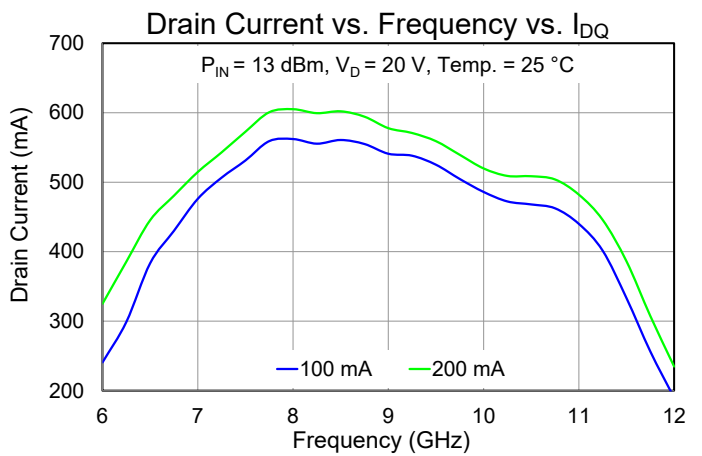
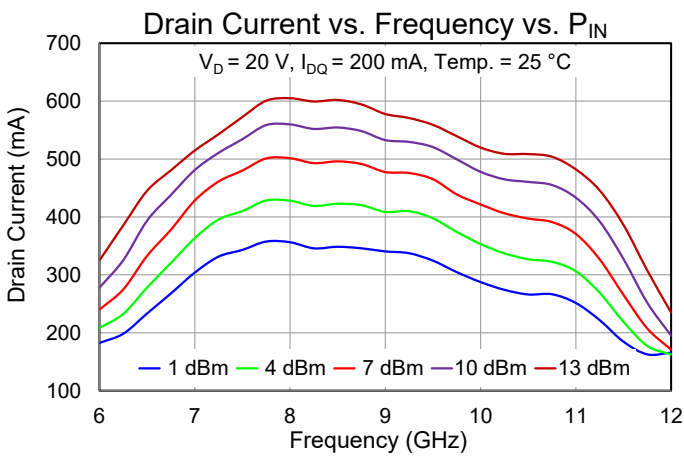
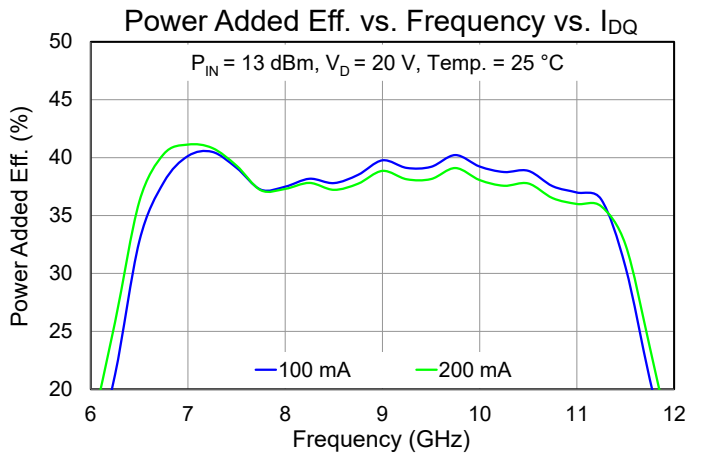
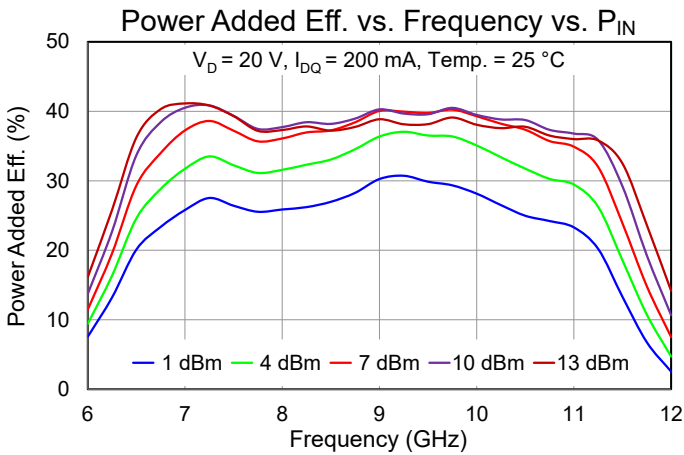
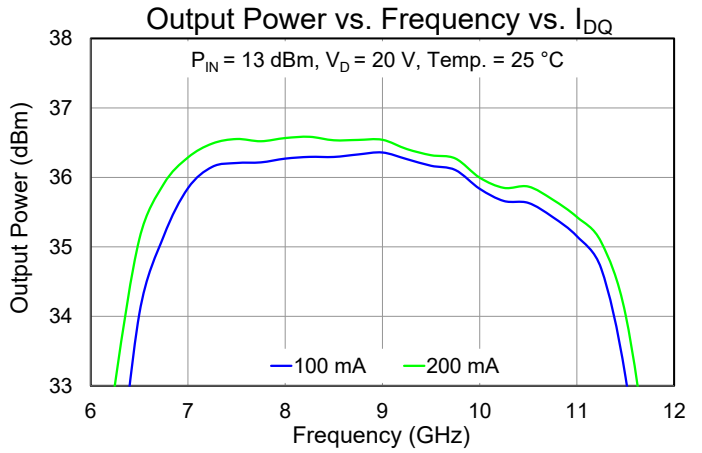
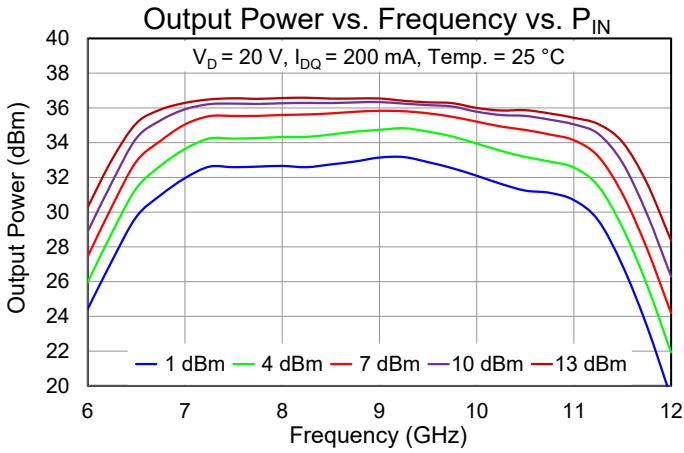

### Performance Plots – Large Signal (CW)

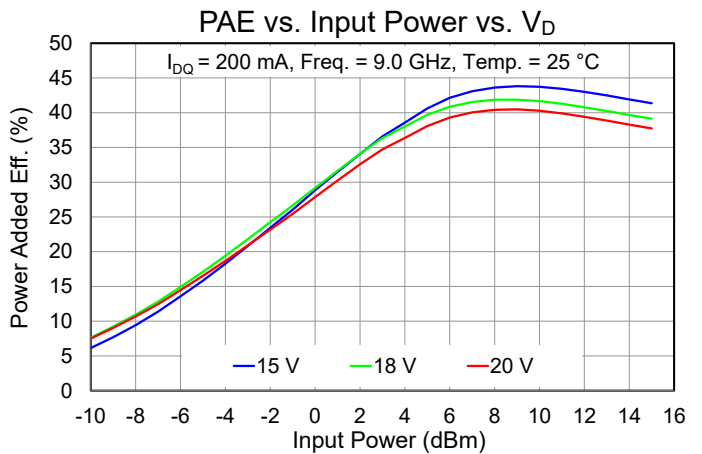
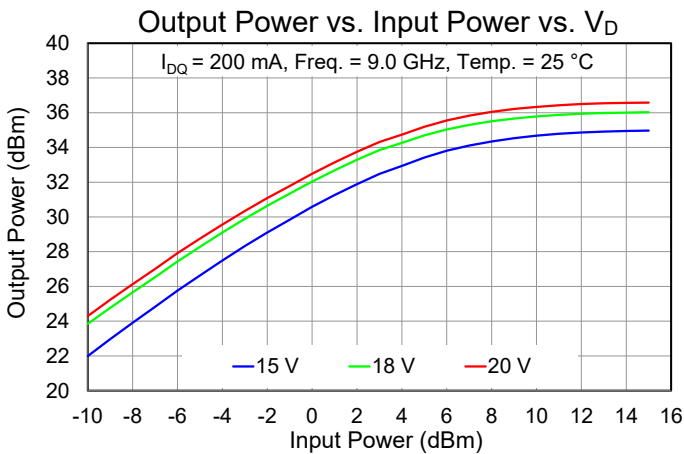
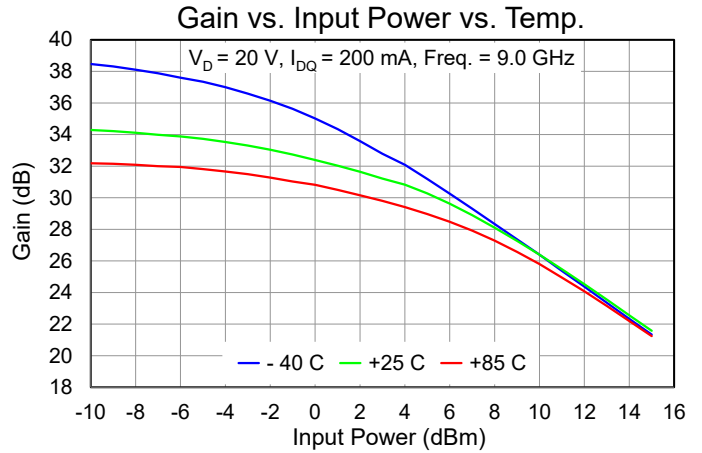
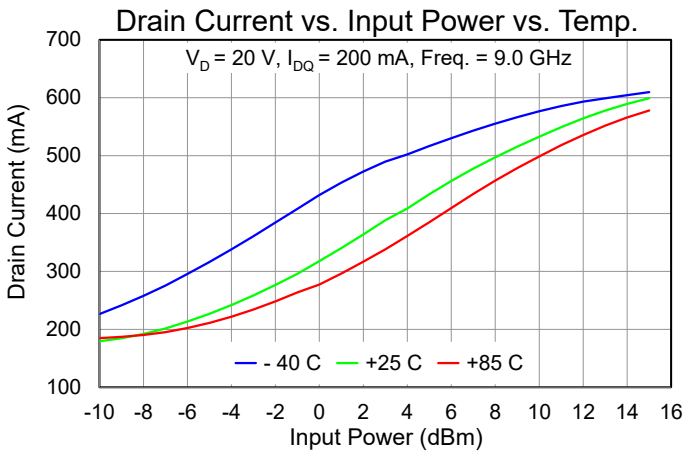
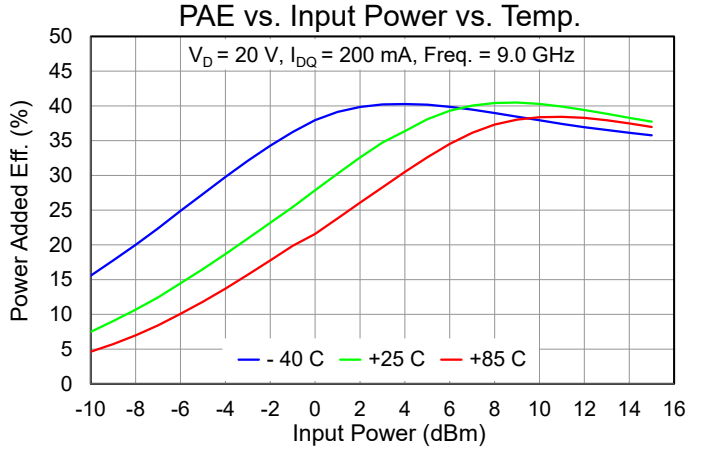
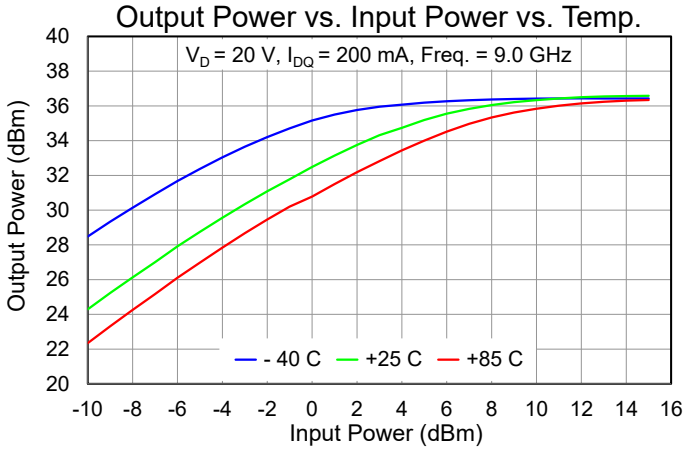

### Performance Plots – Large Signal (CW)

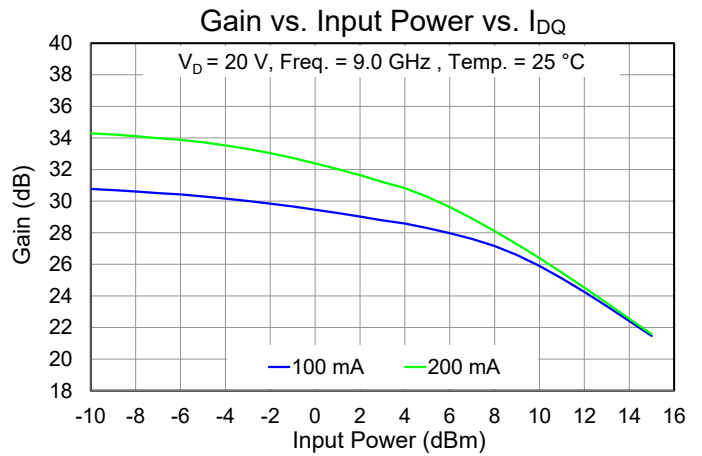
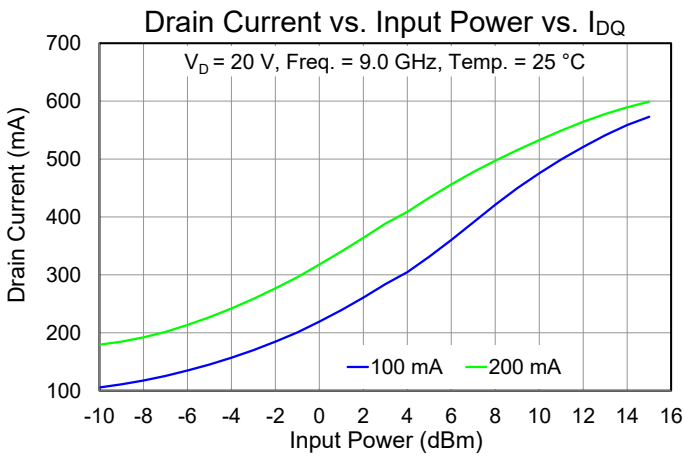
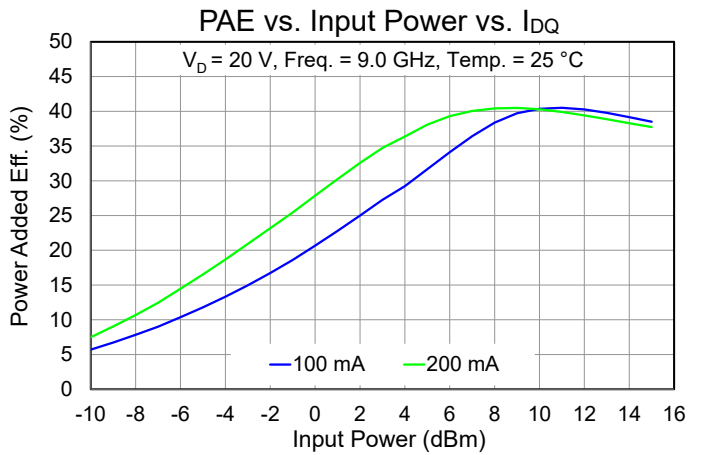
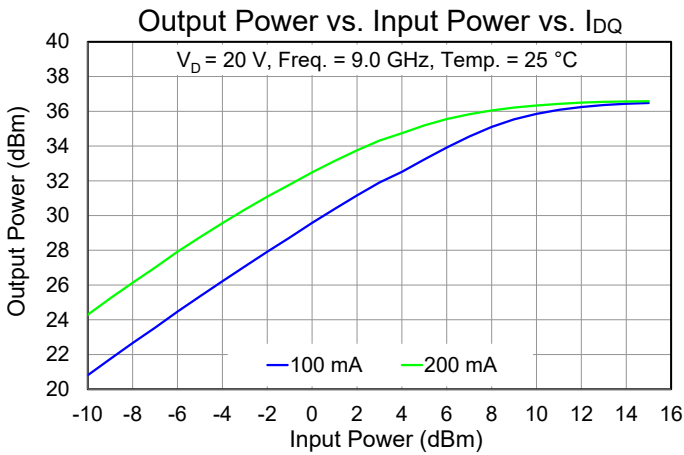
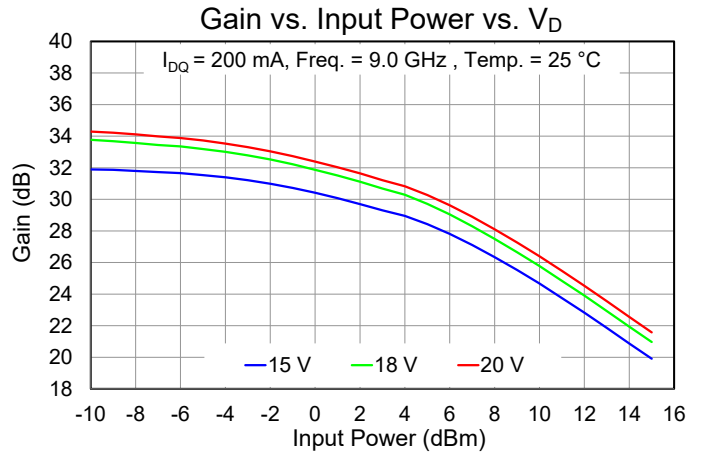
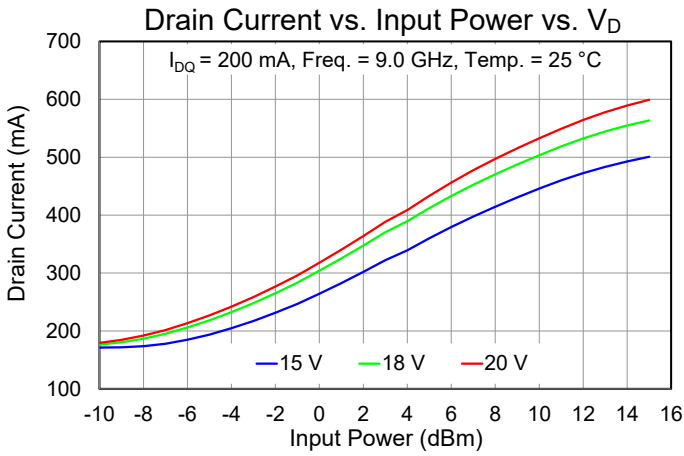

### Performance Plots – Linearity

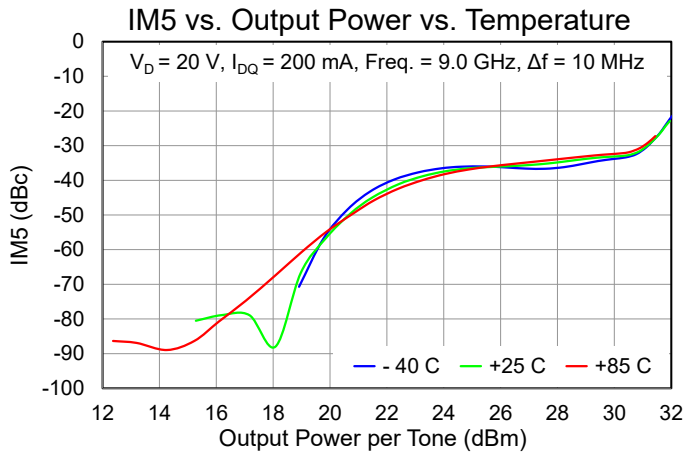
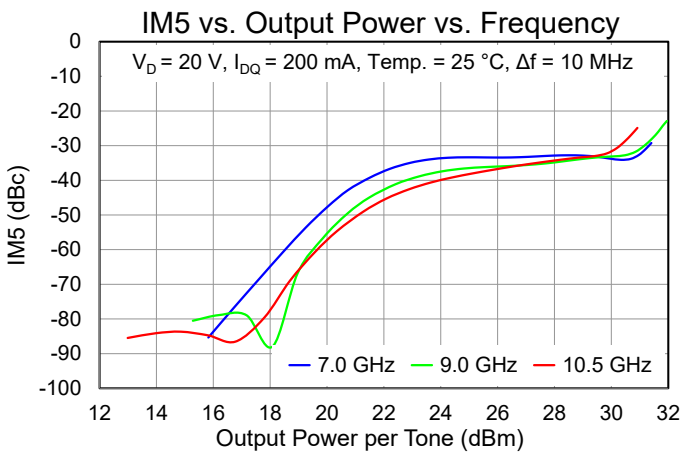
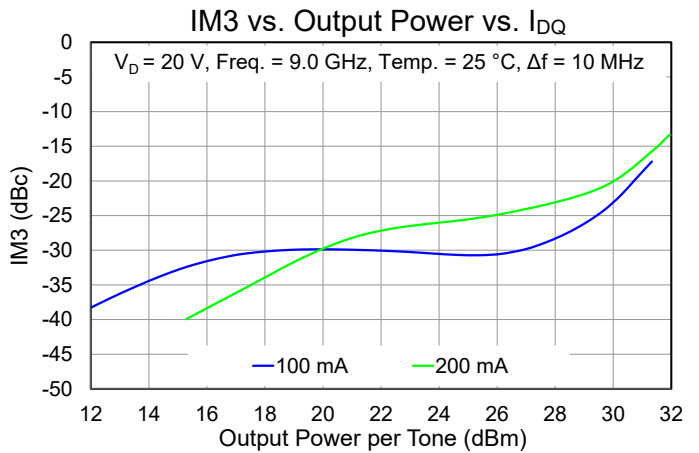
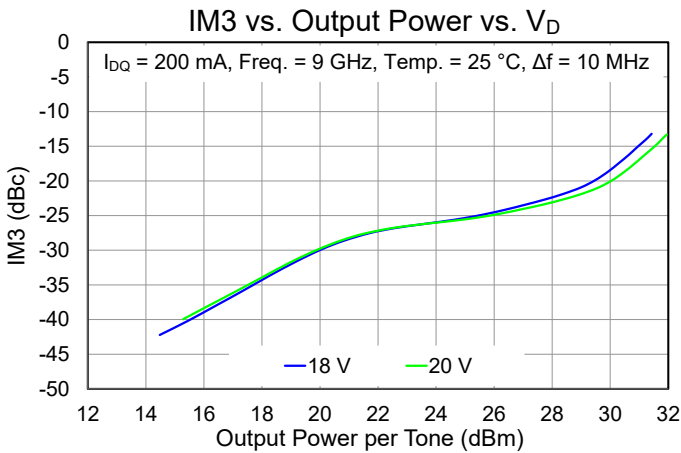
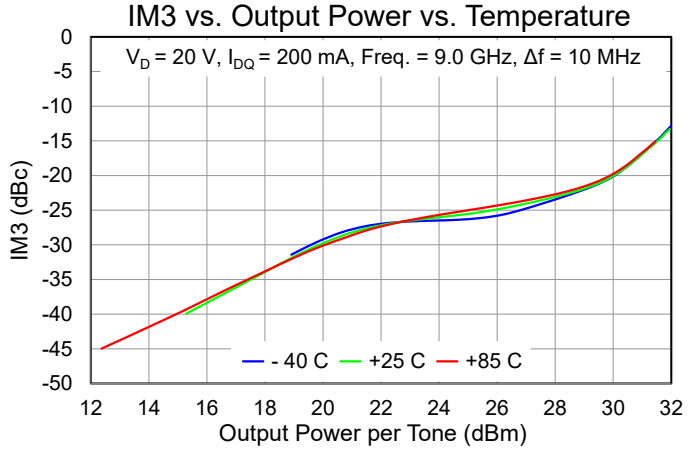
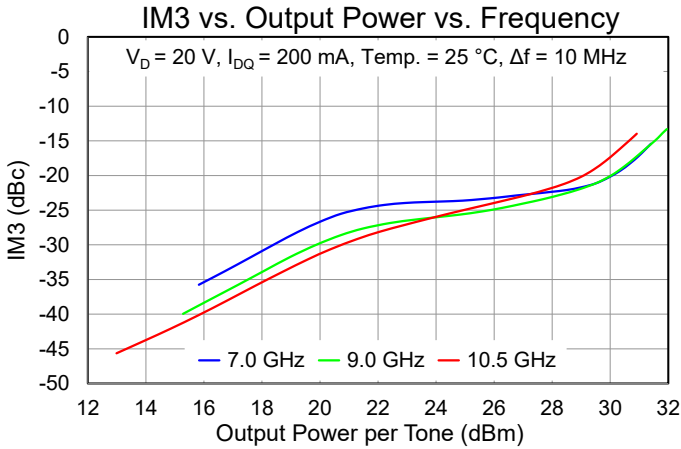

### Performance Plots – Linearity, Harmonics

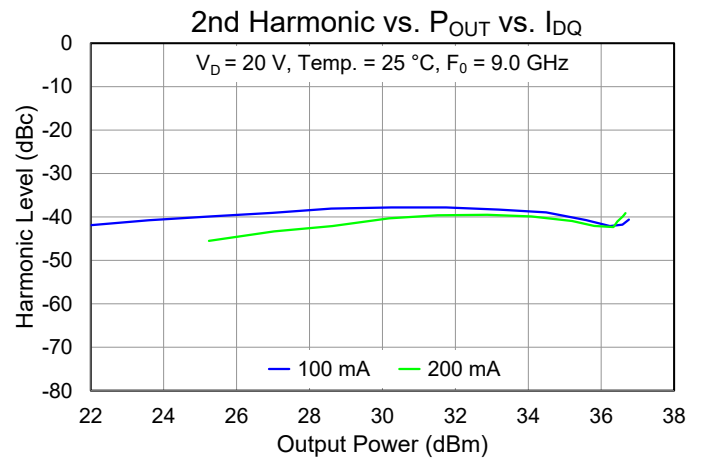
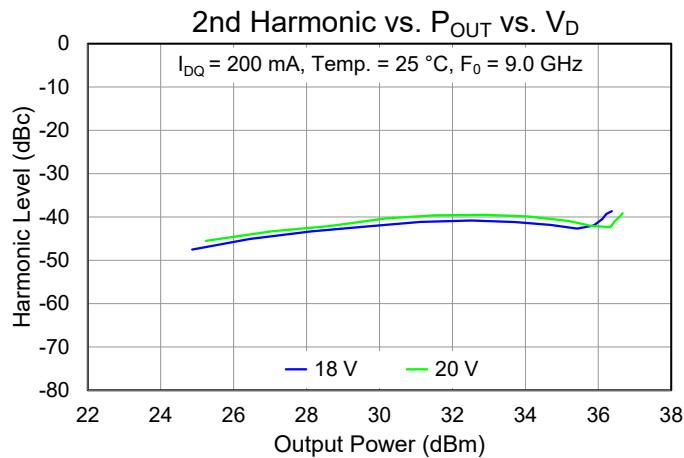
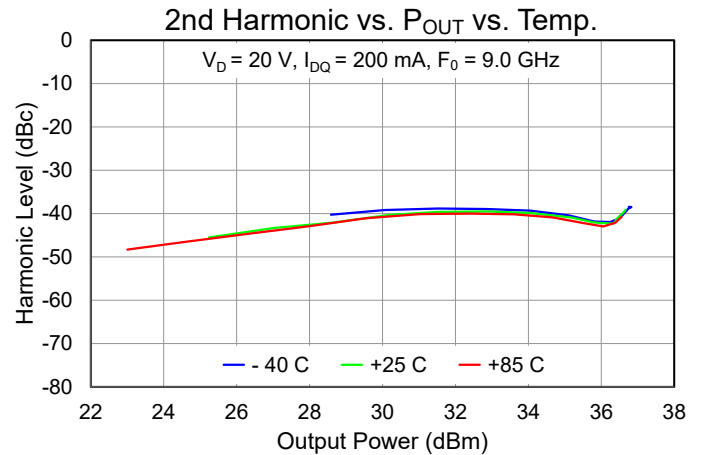
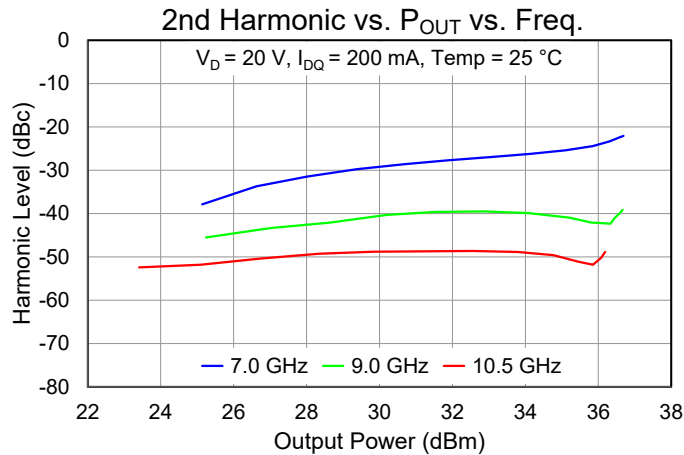
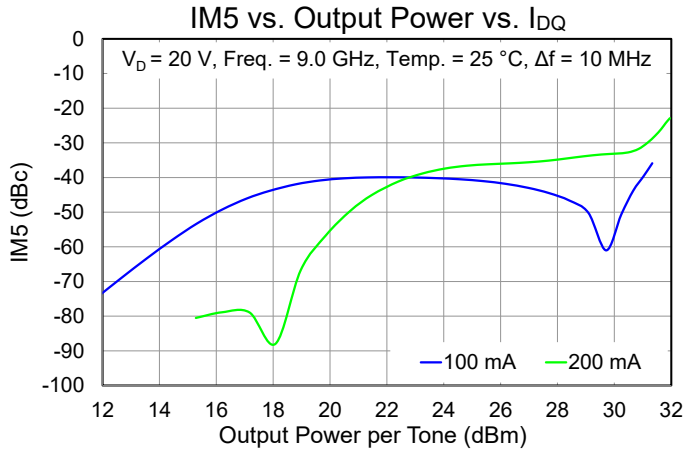
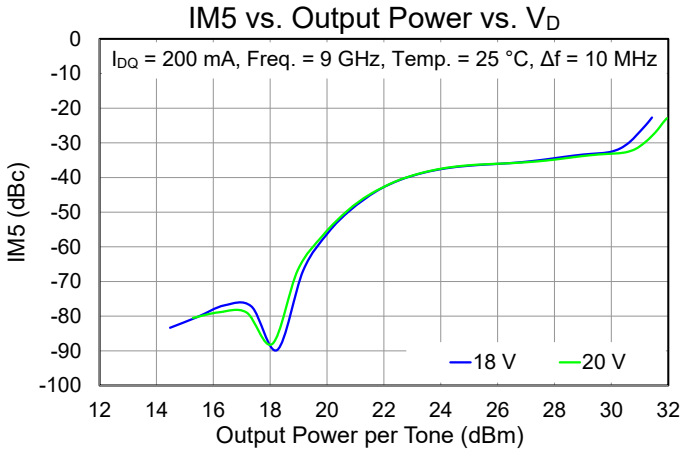

### Performance Plots – Harmonics

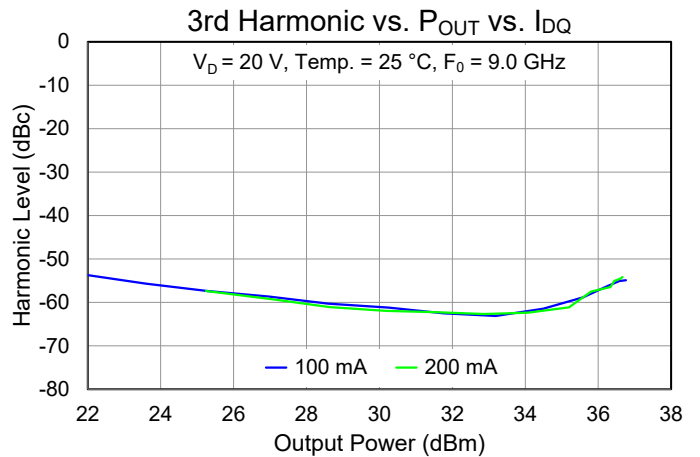
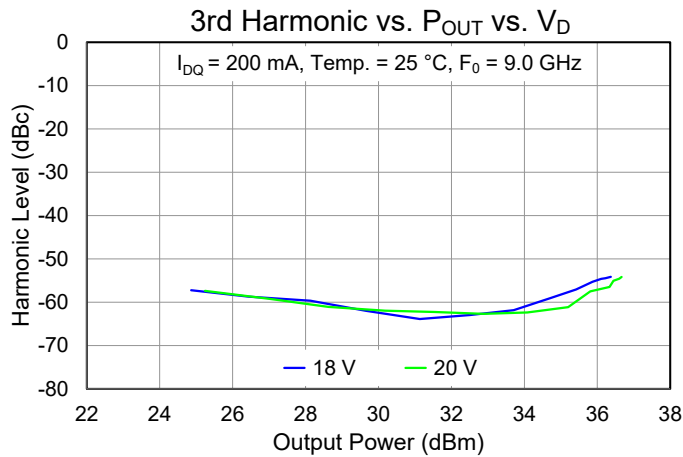
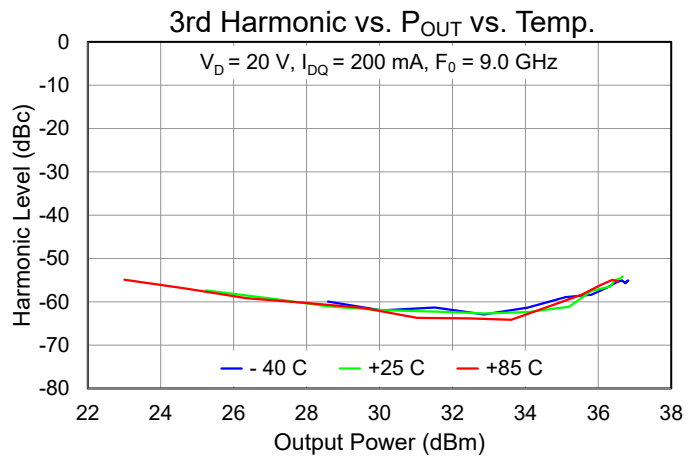
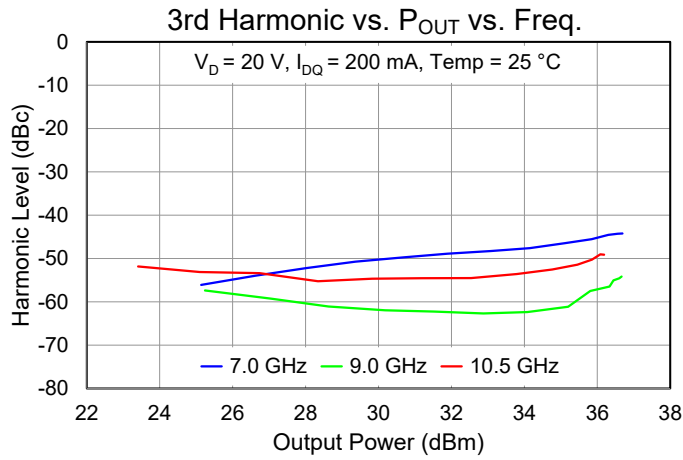

### Performance Plots – Detector Voltage

Note:  $V_{\Delta} = V_{REF} - V_{DET}$

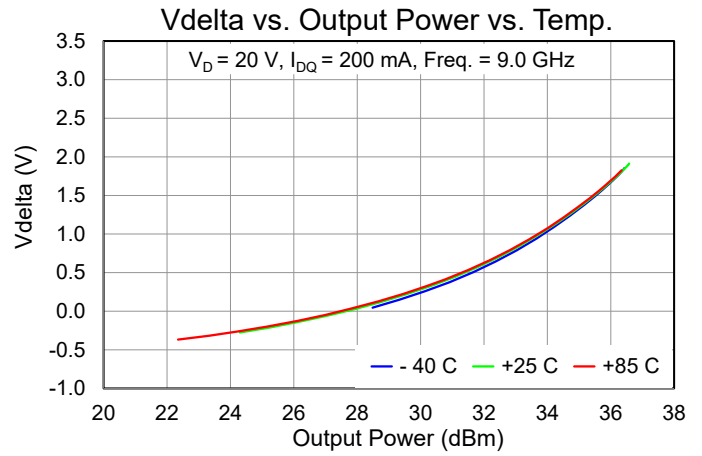
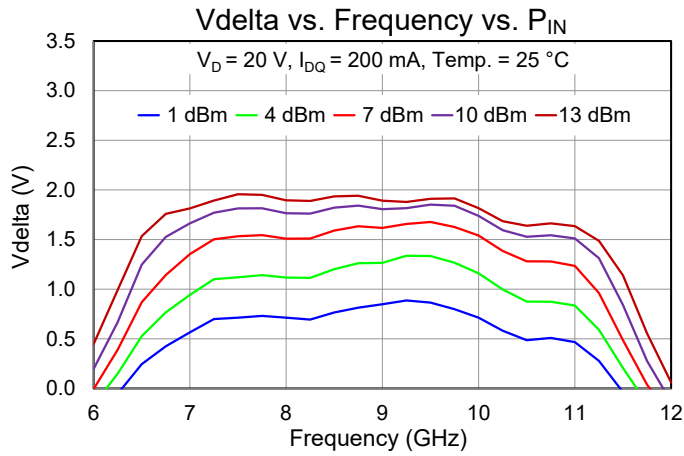
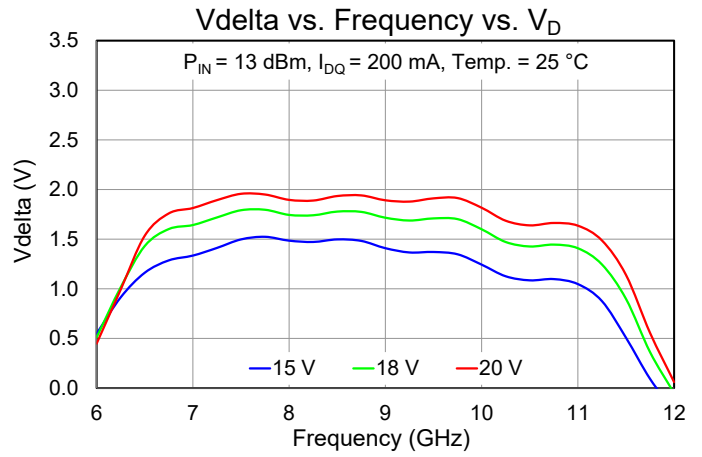
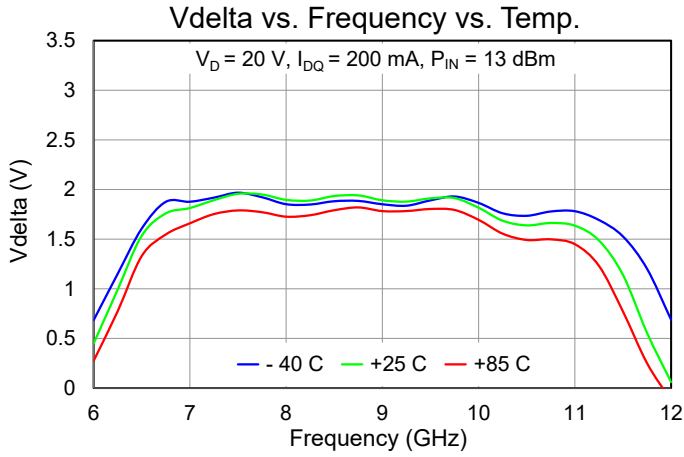

### Performance Plots – Small Signal

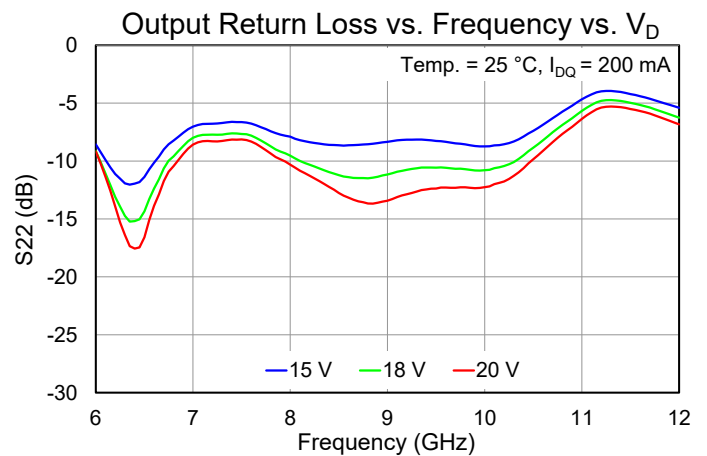
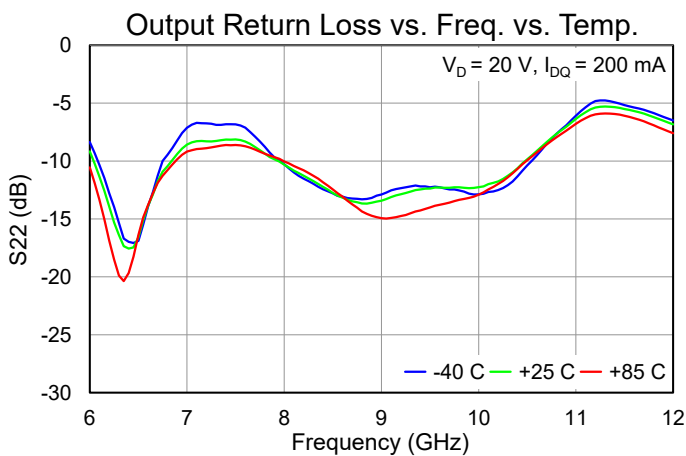
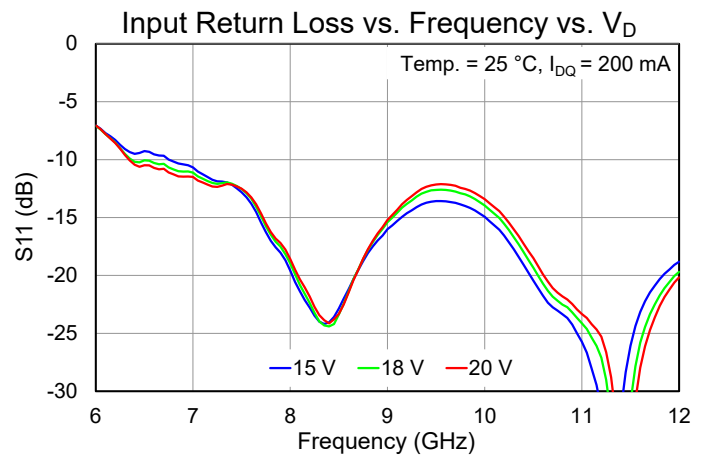
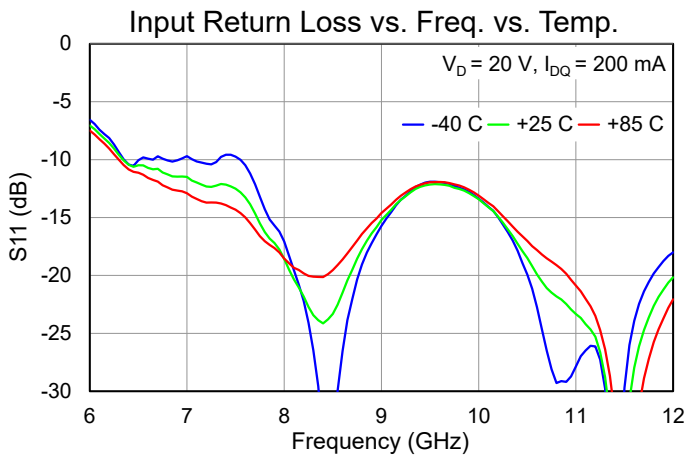
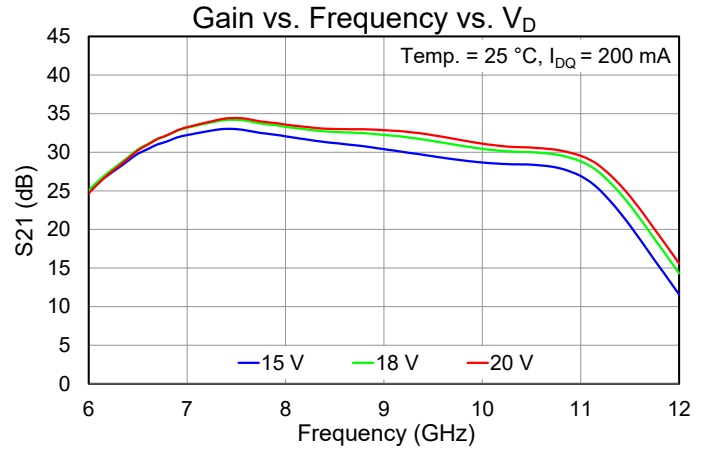
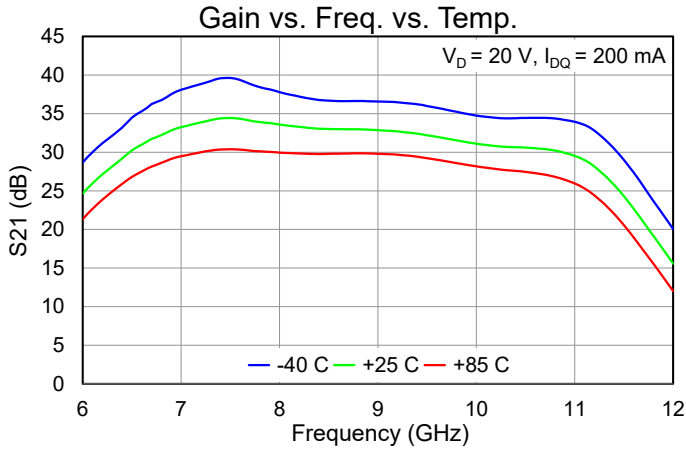

### Performance Plots – Small Signal

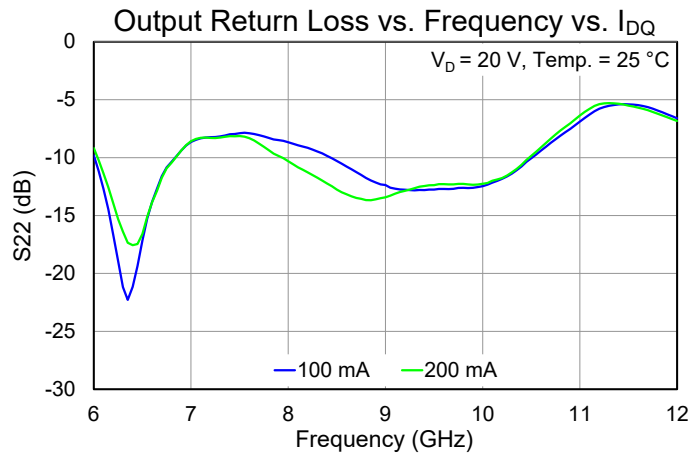
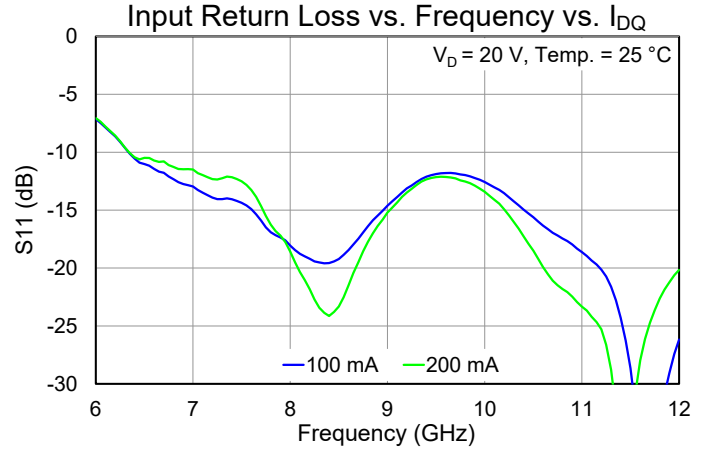
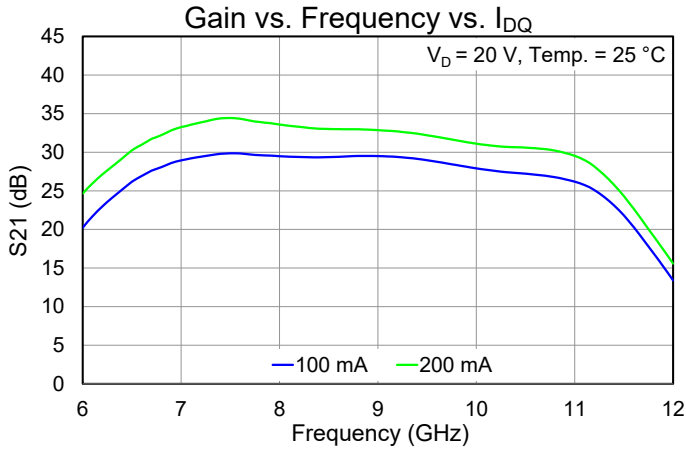

### Thermal and Reliability Information

Parameter	Test Conditions	Value	Units
Thermal Resistance ( $\theta_{JC}$ ) <sup>1</sup>	$T_{BASE} = 85^\circ\text{C}$ , $V_D = +20\text{ V}$ , $I_{DQ} = 200\text{ mA}$ , $P_{DISS} = 4.0\text{ W}$	7.1	$^\circ\text{C/W}$
Channel Temperature ( $T_{CH}$ ) (Quiescent, No RF) <sup>2</sup>		113	$^\circ\text{C}$
Thermal Resistance ( $\theta_{JC}$ ) <sup>1</sup>	$T_{BASE} = 85^\circ\text{C}$ , $V_D = +20\text{ V}$ , $I_{DQ} = 200\text{ mA}$ , Freq = 7.75 GHz, $P_{IN} = 13\text{ dBm}$ , $I_{D\_Drive} = 569\text{ mA}$ , $P_{OUT} = 36.1\text{ dBm}$ , $P_{DISS} = 7.33\text{ W}$	7.5	$^\circ\text{C/W}$
Channel Temperature ( $T_{CH}$ ) (Under RF drive) <sup>2</sup>		140	$^\circ\text{C}$

Notes:

1. Thermal resistance referenced to the back of the package, with a fixed base temperature of 85 °C.
2. IR scan equivalent. Refer to the following document: [GaN Device Channel Temperature, Thermal Resistance, and Reliability Estimates](#)

### Power Dissipation and Maximum Gate Current

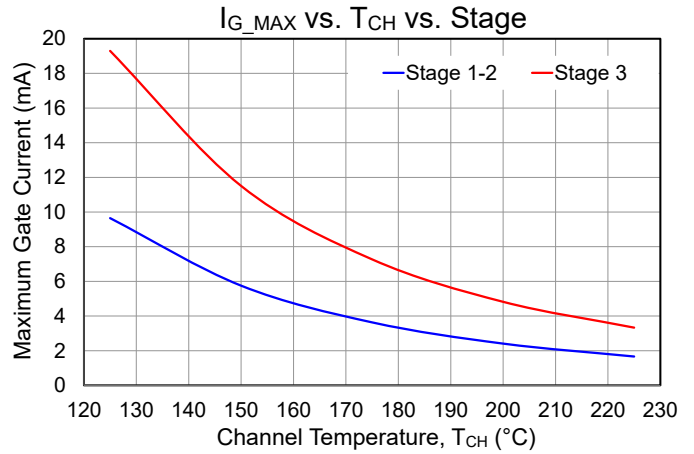
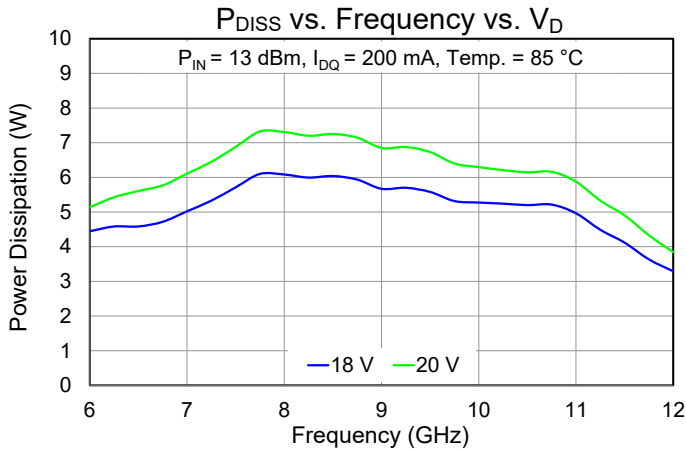

## Application Information

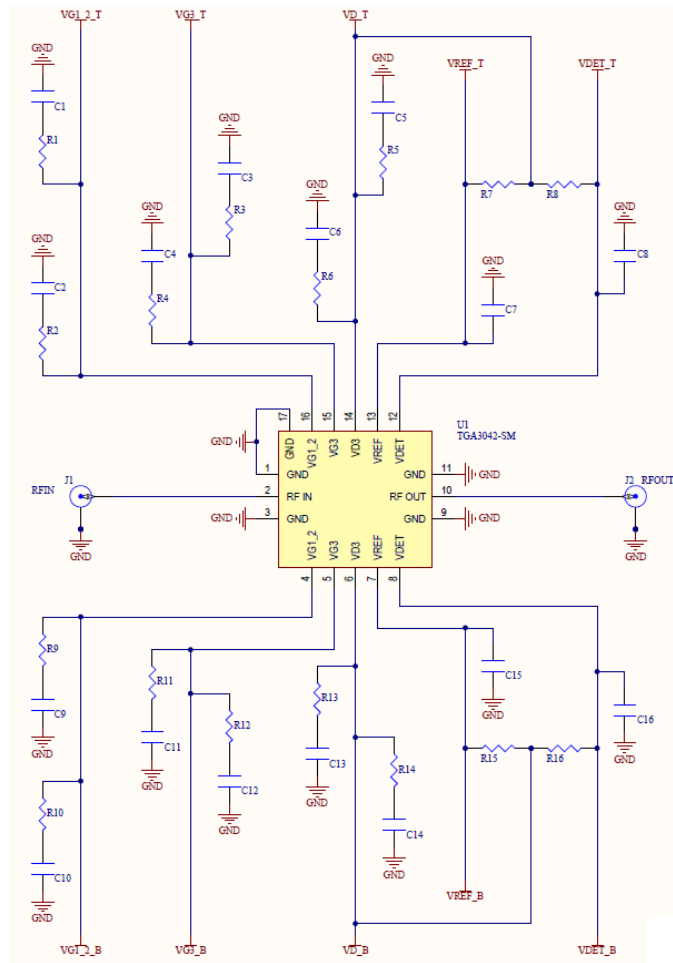

### Bias Up Procedure

1. Set  $I_D$  limit to 1000 mA,  $I_G$  limit to 20 mA
2. Apply -5 V to  $V_G$
3. Apply +20 V to  $V_D$ ; ensure  $I_{DQ}$  is approx. 0 mA
4. Adjust  $V_G$  until  $I_{DQ} = 200$  mA ( $V_G \sim -2.2$  V Typ.).
5. Turn on RF supply

### Bias Down Procedure

1. Turn off RF supply
2. Reduce  $V_G$  to -5 V; ensure  $I_{DQ}$  is approx. 0 mA
3. Set  $V_D$  to 0 V
4. Turn off  $V_D$  supply
5. Turn off  $V_G$  supply

## Evaluation Board (EVB) Layout

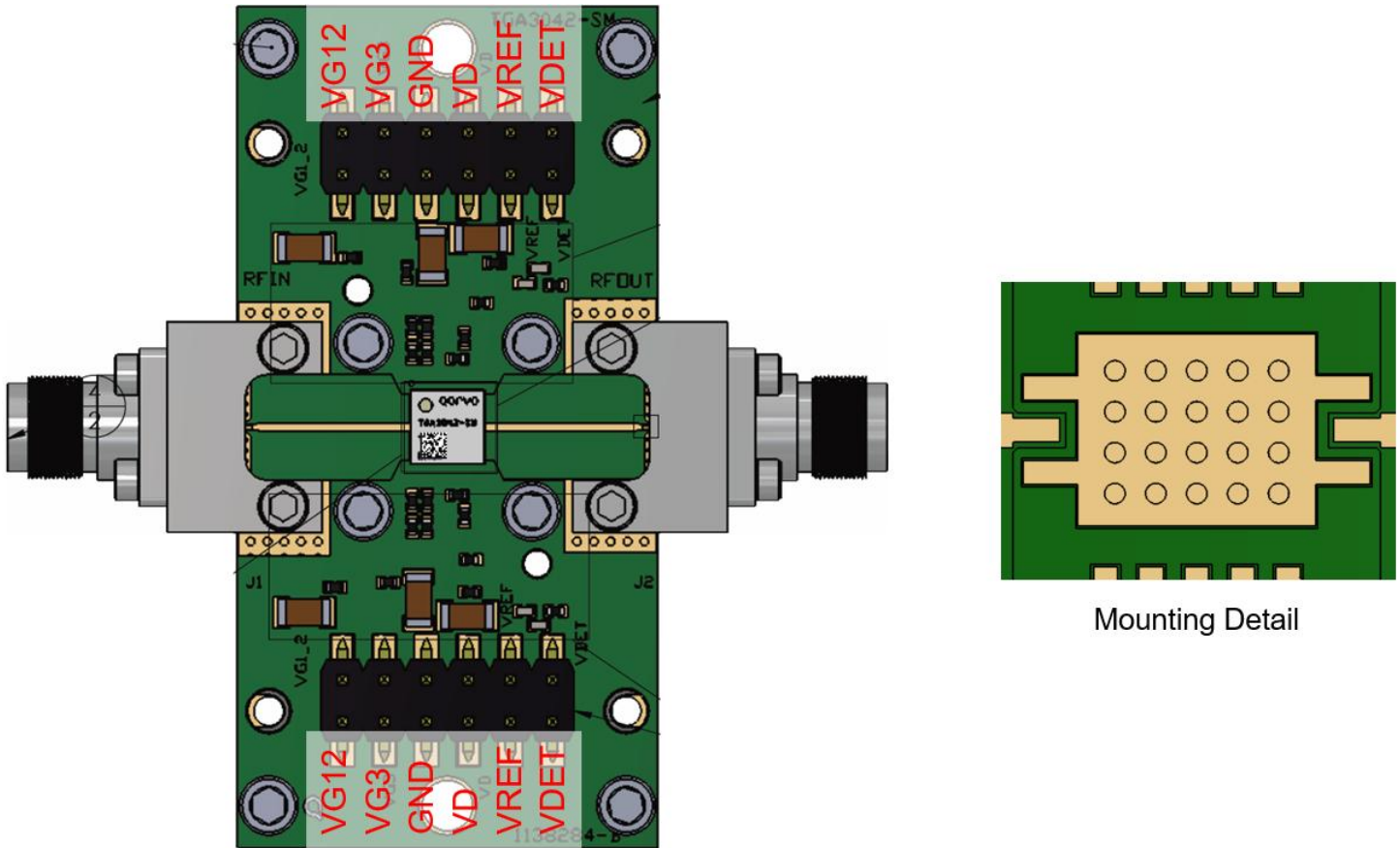

**NOTES:**

1. RF Layer is 8 mil thick Rogers Corp. RO4003C,  $\epsilon_r = 3.38$ . Both metal layers are 0.5 oz. copper.
2. TGA3042-SM can be biased from either the top side or the bottom side. Bypassing components are required for the side(s) being biased. Bypass components are required for the side not biased if using the EVB PCB layout in other applications. Do not include metal traces for applications using the EVB PCB layout if biasing and bypassing from one side only

## Bill of Materials

Reference Des.	Value	Description	Manuf.	Part Number
C1, C3, C5, C10, C12, C14	1.0 uF	CAP CER 50V 5% X7R 1206	Various	
C2, C4, C6–C9, C11, C13, C15, C16	1000 pF	CAP, 0402, 1000pF, 10%, 100V, X7R	Various	
R7, R8, R15, R16	25.5 k $\Omega$	RES, 1/16W, 1%, 0402	Various	
R1–R6, R9–R14	5.1 $\Omega$	RES, 5%, 0402, 1/10W	Various	
J1, J2	N/A	2.92 mm RF Edge Launch Connector	Southwest Microwave	1092-01A-5

### Mechanical Information

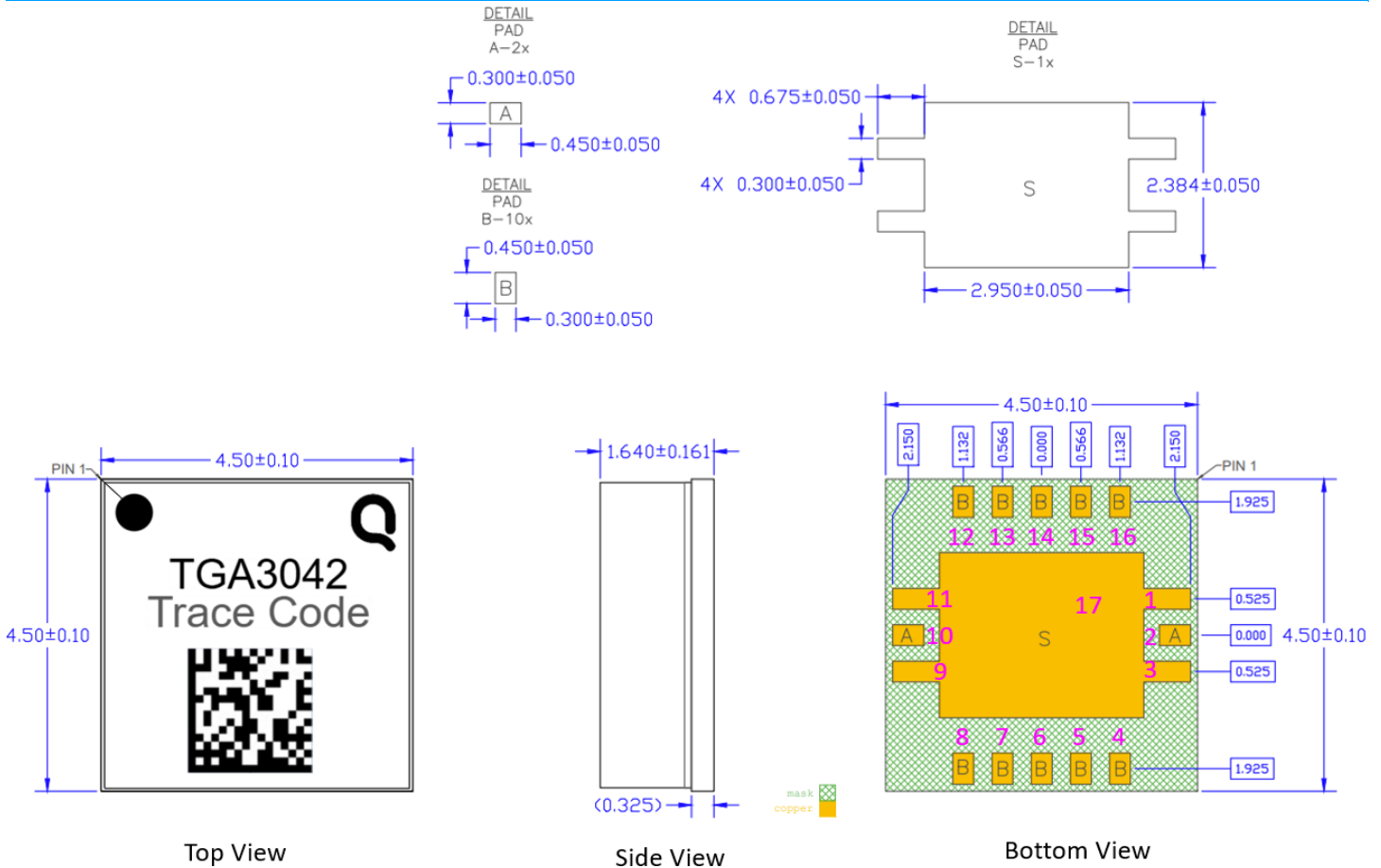

Units: millimeters

Tolerances: unless specified:  $x.xx = \pm 0.25$ ;  $x.xxx = \pm 0.100$

Materials: Base: Laminate. Lid: Laminate

All metalized features are gold plated, Part is epoxy sealed

2DID Marking can be used to trace part manufacturing information

### Pin Description

Pad No.	Symbol	Description
1, 3, 9, 11, Center (17)	GND	Ground. Must be grounded on the PCB. Conductive filled vias recommended for least inductance and improved thermal performance (see Mounting Detail)
2	RF <sub>IN</sub>	RF Input; matched to 50 Ω; DC blocked
4, 16	V <sub>G1-2</sub>	Stage 1-2 Gate Voltage. Can be biased from either side. Bias network is required; see recommended Application Information and EVB Layout above.
5, 15	V <sub>G3</sub>	Stage 3 Gate Voltage. Can be biased from either side. Bias network is required; see recommended Application Information and EVB Layout above.
6, 14	V <sub>D</sub>	Drain voltage; Drain can be biased from either side. Bias network is required; see recommended Application Information and EVB Layout above.
7, 13	V <sub>REF</sub>	Reference voltage
8, 12	V <sub>DET</sub>	Detector voltage
10	RF <sub>OUT</sub>	RF Output; matched to 50 Ω; DC blocked

## Application PCB Land Patterns and Masks

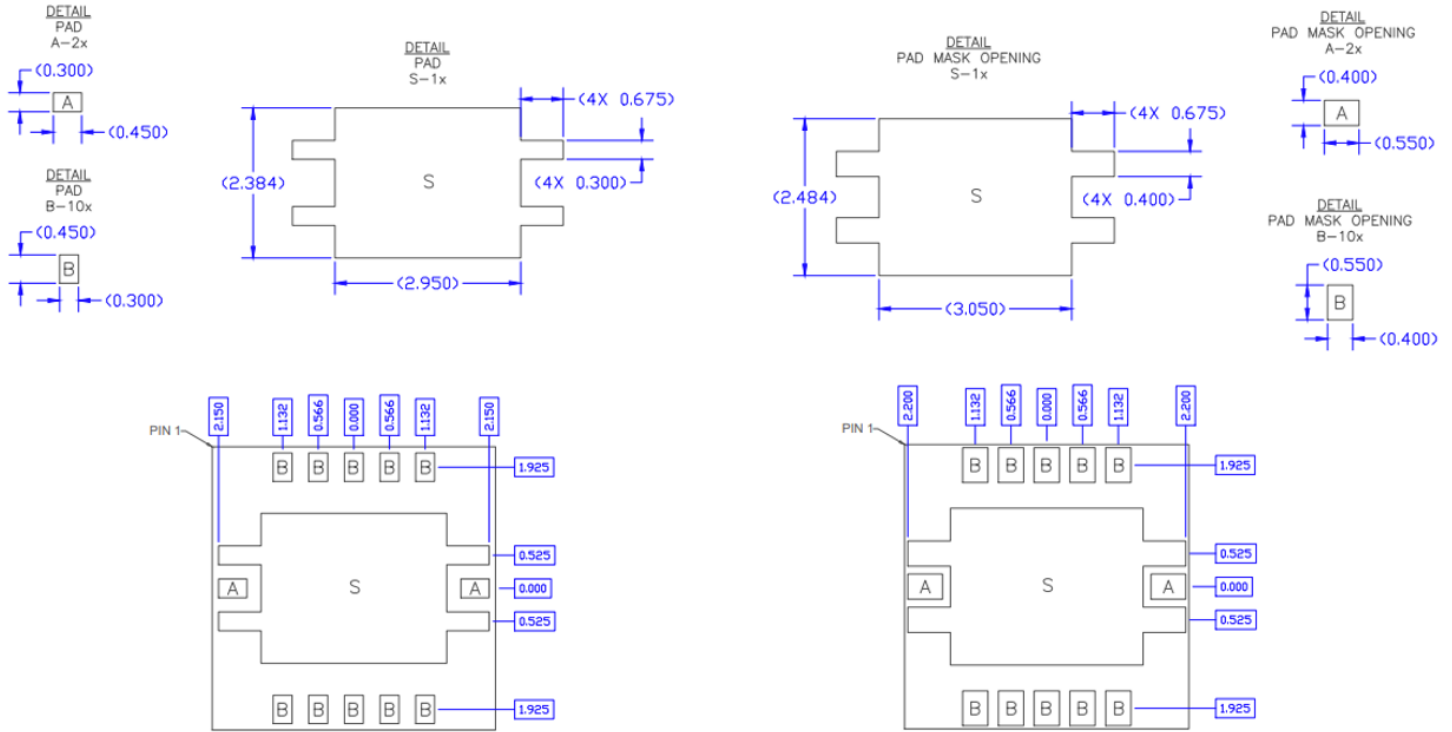

Recommended Land Pattern

Recommended Land Pattern Mask

Units: Millimeters (mm)

Tolerances: unless specified: x.xx = ± 0.25; x.xxx = ± 0.100

## Assembly Notes

Compatible with lead-free soldering processes with 260°C peak reflow temperature.

This package is air-cavity and non-hermetic, and therefore cannot be subjected to aqueous washing. The use of no-clean solder to avoid washing after soldering is highly recommended.

Contact plating: Ni-Au.

Solder rework not recommended.

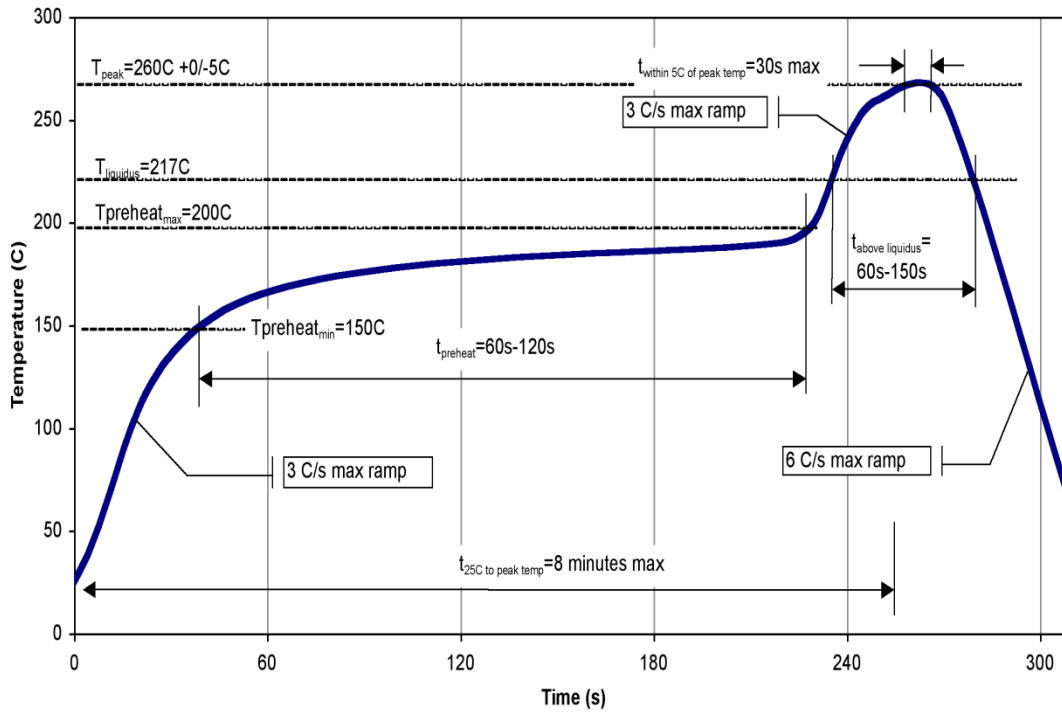

Recommended Soldering Temperature Profile

## Handling Precautions

Parameter	Rating	Standard
ESD – Human Body Model (HBM)	0B	ESDA / JEDEC JS-001-2017
ESD – Charged Device Model (CDM)	C2a	ESDA / JEDEC JS-002-2018
MSL – Convection Reflow 260 °C	3	IPC/JEDEC J-STD-020



**Caution!**  
ESD-Sensitive Device

## RoHS Compliance

This product is compliant with the 2011/65/EU RoHS directive (Restrictions on the Use of Certain Hazardous Substances in Electrical and Electronic Equipment), as amended by Directive 2015/863/EU.

This product also has the following attributes:

- Lead Free
- Antimony Free
- TBBP-A (C<sub>15</sub>H<sub>12</sub>Br<sub>4</sub>O<sub>2</sub>) Free
- PFOS Free
- SVHC Free

## Contact Information

For the latest specifications, additional product information, worldwide sales and distribution locations:

**Tel: 1-844-890-8163**

**Web: [www.qorvo.com](http://www.qorvo.com)**

**Email: [info-sales@qorvo.com](mailto:info-sales@qorvo.com)**

For technical questions and application information: **Email: [info-products@qorvo.com](mailto:info-products@qorvo.com)**

## Important Notices

The information contained in this Data Sheet and any associated documents (“Data Sheet Information”) is believed to be reliable; however, Qorvo makes no warranties regarding the Data Sheet Information and assumes no responsibility or liability whatsoever for the use of or reliance on said information. All Data Sheet Information is subject to change without notice. Customers should obtain and verify the latest relevant Data Sheet Information before placing orders for Qorvo® products. Information concerning Qorvo’s product life cycles is available at <https://www.qorvo.com/support/product-lifecycle-information>. Data Sheet Information or the use thereof does not grant, explicitly, implicitly or otherwise any rights or licenses with respect to patents or any other intellectual property whether with regard to such Data Sheet Information itself or anything described by such information.

Qorvo grants you permission to use this Data Sheet and any associated resources only to develop an application that uses the Qorvo products described in the Data Sheet and any associated resources. Other reproduction and display of this Data Sheet and any associated resources is prohibited.

Qorvo’s products are provided subject to Qorvo’s [Terms of Sale](#) or provided in conjunction with such Qorvo products. Qorvo objects to and rejects any additional or different terms customer may have proposed regarding the purchase of Qorvo products.

DATA SHEET INFORMATION DOES NOT CONSTITUTE A WARRANTY WITH RESPECT TO THE PRODUCTS DESCRIBED HEREIN, AND QORVO HEREBY DISCLAIMS ANY AND ALL WARRANTIES WITH RESPECT TO SUCH PRODUCTS WHETHER EXPRESS OR IMPLIED BY LAW, COURSE OF DEALING, COURSE OF PERFORMANCE, USAGE OF TRADE OR OTHERWISE, INCLUDING THE IMPLIED WARRANTIES OF MERCHANTABILITY AND FITNESS FOR A PARTICULAR PURPOSE. Without limiting the generality of the foregoing, Qorvo® products are not warranted or authorized for use as critical components in medical, life-saving, or life-sustaining applications, or other applications where a failure would reasonably be expected to cause severe personal injury or death. Applications described in the Data Sheet Information are for illustrative purposes only. Customers are responsible for validating that a particular product described in the Data Sheet Information is suitable for use in a particular application.

© 2026 Qorvo US, Inc. All rights reserved. This document is subject to copyright laws in various jurisdictions worldwide and may not be reproduced or distributed, in whole or in part, without the express written consent of Qorvo US, Inc.

## Looking for pricing, stock, or lifecycle information?

Click below to explore more details on WIN SOURCE:

 [View TGA3042-SMTR7 on WIN SOURCE](#)

 [Qorvo US Inc. Information](#)

## Optimize Your Supply Chain with WIN SOURCE Solutions

-  Global Sourcing Solution
-  Obsolete Management
-  Cost Control Management
-  Shortage Management
-  Alternative Solution
-  Excess Inventory Management