

G6B

PCB Power Relay

High Capacity and High Dielectric Strength Miniature Relay with Fully Sealed Construction in 5 A (8 A) SPST-NO(1a), SPST-NO+SPST-NC(1a1b), DPST-NO(2a), DPST-NC(2b) Types

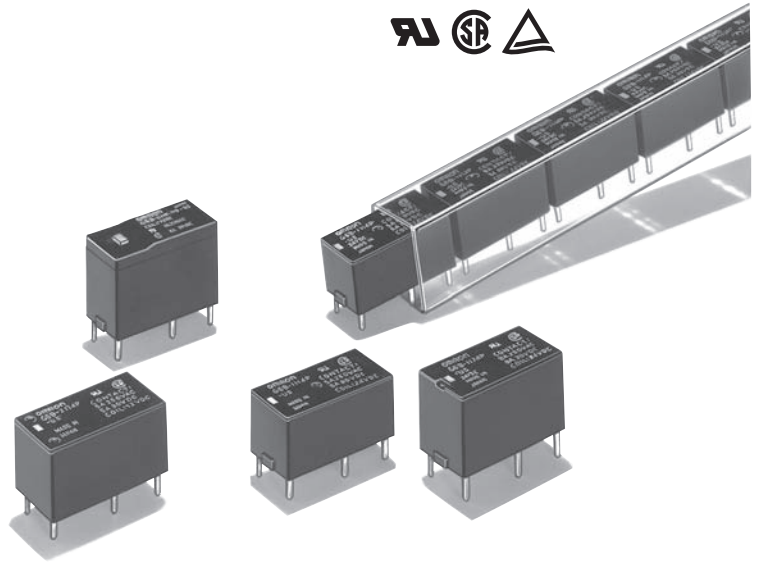

- P6B model for connecting sockets are available.
- High insulation with dielectric strength of 3,000VAC between coil and contacts (impulse withstand voltage of 6 kV).
- Standard model conforms to UL/CSA standards.
- AgSnIn contacts suitable for loads that generate surge voltage (inductive load, capacity load, etc.) are available. (-FD type)
- Ultrasonic cleanable models are available. (-U type)
- Operation indicator & built-in surge absorption diode models are available. (-ND type)
- 2-Pole type available.
- High-reliability models are available.

G6B-1184P-US model (The relay used in Terminal Relay G6B-48BND)

RoHS Compliant

Application Examples

- Ideal for output applications of control equipments

Model Number Legend

G6B□-□□□□□□-□-□-□-□-□-□
 1 2 3 4 5 6 7 8 9 10 11

1. Relay Function

- None: Single-side stable
 U : Single-winding latching (G6B□-1114 models only)
 K : Double-winding latching (G6B□-1114 models only)

2. Contact Form

- 21: SPST-NO + SPST-NC
 22: DPST-NO
 20: DPST-NC
 11: SPST-NO

3. Classification

- 1: Standard
 7: High-capacity
 8: Single crossbar

4. Enclosure rating

- 4: Fully sealed
 7: Flux protection

5. Terminal Shape

- P: Straight PCB terminals
 Socket mounting terminals
 C: Self-clinching PCB

6. Contact material

- None: Standard (Ag-alloy (Cd free))
 FD : AgSnIn contact
 (Suitable for DC inductive load with high inrush current)

7. Coil Polarity

- None: 5, 6 Terminal (+), 1, 2 Terminal (-)
 1 : 5, 6 Terminal (-), 1, 2 Terminal (+)

8. Operation Indicator Diode Availability

- None: Standard
 ND : Operation indicator & coil surge absorption diode
 (for -1177 type only)

9. Approved Standards

- US: UL/CSA

10. Washability

- None: Standard
 U : For ultrasonically cleanable

11. Mounting

- None: Mounted directly to PCB
 P6B : Mounted to Socket

Ordering Information

Standard Models (UL, CSA certified)

Number of poles	Relay Function	Contact form	Contact material Terminals	Standard (Ag-alloy (Cd free))		AgSnIn contact		Minimum packing unit
				Model	Rated coil voltage	Model	Rated coil voltage	
1-pole	Single-side stable	SPST-NO (1a) (Standard)	Straight PCB	G6B-1114P-US	5, 6, 12, 24 VDC	G6B-1114P-FD-US	5, 6, 12, 24 VDC	100 pcs/tray
			Self-clinching PCB	G6B-1114C-US	5, 6, 12, 24 VDC	G6B-1114C-FD-US	12, 24 VDC	
		SPST-NO (1a) (High-capacity)	Straight PCB	G6B-1174P-US	5, 6, 12, 24 VDC	G6B-1174P-FD-US	5, 6, 12, 24 VDC	20 pcs/tube
			Self-clinching PCB	G6B-1174C-US	5, 12, 24 VDC	G6B-1174C-FD-US	5, 12, 24 VDC	
		SPST-NO (1a) (High-reliability)	Straight PCB	G6B-1184P-US	5, 12, 24 VDC	---	---	100 pcs/tray
			Self-clinching PCB	---	---	---	---	
	Single-winding latching	SPST-NO (1a) (Standard)	Straight PCB	G6BU-1114P-US	5, 6, 12, 24 VDC	G6BU-1114P-FD-US	5, 12, 24 VDC	100 pcs/tray
			Self-clinching PCB	G6BU-1114C-US	12 VDC	---	---	
	Double-winding latching	SPST-NO (1a) (Standard)	Straight PCB	G6BK-1114P-US	5, 6, 12, 24 VDC	G6BK-1114P-FD-US	5, 6, 12, 24 VDC	100 pcs/tray
			Self-clinching PCB	G6BK-1114C-US	5, 6, 12, 24 VDC	G6BK-1114C-FD-US	24 VDC	
	Single-side stable	SPST-NO (1a) (Built-in high-capacity operation indicator & diode)	Straight PCB	G6B-1177P-ND-US	5, 12, 24 VDC	G6B-1177P-FD-ND-US	5, 12, 24 VDC	100 pcs/tray
			Self-clinching PCB	G6B-1177C-ND-US	5, 12, 24 VDC	G6B-1177C-FD-ND-US	12, 24 VDC	
2-pole	Single-side stable	SPST-NO (1a)+ SPST-NC (1b) (Standard)	Straight PCB	G6B-2114P-US	5, 6, 12, 24 VDC	G6B-2114P-FD-US	5, 6, 12, 24 VDC	100 pcs/tray
			Self-clinching PCB	G6B-2114C-US	5, 12, 24 VDC	G6B-2114C-FD-US	5, 12 VDC	
		DPST-NO (2a) (Standard)	Straight PCB	G6B-2214P-US	5, 6, 12, 24 VDC	G6B-2214P-FD-US	5, 6, 12, 24 VDC	
			Self-clinching PCB	G6B-2214C-US	5, 12, 24 VDC	G6B-2214C-FD-US	5, 12, 24 VDC	
		DPST-NC (2b) (Standard)	Straight PCB	G6B-2014P-US	5, 6, 12, 24 VDC	G6B-2014P-FD-US	5, 6, 12, 24 VDC	
			Self-clinching PCB	G6B-2014C-US	5, 6, 12, 24 VDC	G6B-2014C-FD-US	12, 24 VDC	

Note: AgSnIn contact models are highly welding-resistant, and roughening of contacts due to inrush current and inductive load is lessened.

Models for Reverse Coil Polarity

Number of poles	Relay Function	Contact form	Contact material Terminals	Standard (Ag-alloy (Cd free))		AgSnIn contact		Minimum packing unit
				Model	Rated coil voltage	Model	Rated coil voltage	
1-pole	Single-side stable	SPST-NO (1a) (Standard)	Straight PCB	G6B-1114P-1-US	5, 6, 12, 24 VDC	G6B-1114P-FD-1-US	24 VDC	100 pcs/tray
			Self-clinching PCB	---	---	---	---	
		SPST-NO (1a) (High-capacity)	Straight PCB	G6B-1174P-1-US	5, 12, 24 VDC	---	---	20 pcs/tube
			Self-clinching PCB	---	---	---	---	
	Single-winding latching	SPST-NO (1a) (Standard)	Straight PCB	G6BU-1114P-1-US	5, 12 VDC	---	---	100 pcs/tray
			Self-clinching PCB	---	---	---	---	
	Double-winding latching	SPST-NO (1a) (Standard)	Straight PCB	G6BK-1114P-1-US	5, 6, 12, 24 VDC	---	---	100 pcs/tray
			Self-clinching PCB	---	---	---	---	
2-pole	Single-side stable	SPST-NO (1a)+ SPST-NC (1b) (Standard)	Straight PCB	G6B-2114P-1-US	5, 6, 12, 24 VDC	G6B-2114P-FD-1-US	12, 24 VDC	100 pcs/tray
			Self-clinching PCB	---	---	---	---	
		DPST-NO (2a) (Standard)	Straight PCB	G6B-2214P-1-US	5, 12, 24 VDC	---	---	
			Self-clinching PCB	---	---	---	---	

Note: AgSnIn contact models are highly welding-resistant, and roughening of contacts due to inrush current and inductive load is lessened.

● Models for Ultrasonically Cleanable

Number of poles	Relay Function	Contact form	Contact material Terminals	Standard (Ag-alloy (Cd free))		AgSnIn contact		Minimum packing unit
				Model	Rated coil voltage	Model	Rated coil voltage	
1-pole	Single-side stable	SPST-NO (1a) (Standard)	Straight PCB	G6B-1114P-US-U	5, 6, 12, 24 VDC	G6B-1114P-FD-US-U	6, 12, 24 VDC	100 pcs/tray
			Self-clinching PCB	G6B-1114C-US-U	5, 12, 24 VDC	---	---	
	Single-winding latching	SPST-NO (1a) (Standard)	Straight PCB	G6BU-1114P-US-U	24 VDC	---	---	
			Self-clinching PCB	---	---	---	---	
	Double-winding latching	SPST-NO (1a) (Standard)	Straight PCB	G6BK-1114P-US-U	5, 6, 12, 24 VDC	G6BK-1114P-FD-US-U	12, 24 VDC	
			Self-clinching PCB	G6BK-1114C-US-U	24 VDC	---	---	
2-pole	Single-side stable	SPST-NO (1a)+ SPST-NC (1b) (Standard)	Straight PCB	G6B-2114P-US-U	5, 12, 24 VDC	G6B-2114P-FD-US-U	5, 12, 24 VDC	
			Self-clinching PCB	---	---	---	---	
		DPST-NO (2a) (Standard)	Straight PCB	G6B-2214P-US-U	5, 6, 12, 24 VDC	G6B-2214P-FD-US-U	5, 12, 24 VDC	
			Self-clinching PCB	G6B-2214C-US-U	12, 24 VDC	---	---	
		DPST-NC (2b) (Standard)	Straight PCB	G6B-2014P-US-U	5, 12, 24 VDC	G6B-2014P-FD-US-U	5, 12, 24 VDC	
			Self-clinching PCB	---	---	---	---	

Note: When ordering, add the rated coil voltage to the model number.

Example: G6B-1114P-US DC5

 └── Rated coil voltage

However, the notation of the coil voltage on the product case as well as on the packing will be marked as □□ VDC.

● Connecting Sockets (Sold Separately)

Applicable relay	Model	Minimum ordering unit
G6B-1114P(-FD)-US-P6B G6B-1174P(-FD)-US-P6B G6B-1177P(-FD)-ND-US-P6B G6BU-1114P-US-P6B	P6B-04P	20 pcs
G6BK-1114P-US-P6B	P6B-06P	
G6B-2114P-US-P6B G6B-2214P-US-P6B G6B-2014P-US-P6B	P6B-26P	
Removal Tool	P6B-Y1	1 pcs
Hold-down Clips	P6B-C2	

- Note 1. G6B-1174P-US-P6B and G6B-1177P-ND-US-P6B are rated for 8 A when mounted on a PCB. However, when used with the P6B-04P socket models, the allowable current is derated to 5 A.
2. The P6B sockets are designed to be used with G6B-□□□□P(-FD)-US-P6B relays. Only use G6B relays that include "-P6B" in their model numbers with the sockets. Do not use standard G6B's that omit "-P6B" from their model numbers with the sockets.
3. The hold-down clips of the P6B-C2 model are not suitable for the G6B-1174P and G6B-1177P models since they have different heights.
4. Products with UL/CSA certification marks will be supplied for orders of standard models.

■ Ratings

● Coil: 1-Pole, Single-side Stable Type (Including models for ultrasonically cleanable)

Item Rated voltage	Rated current (mA)	Coil resistance (Ω)	Must operate voltage (V)	Must release voltage (V)	Max. voltage (V)	Power consumption (mW)
			% of rated voltage			
5 VDC	40	125	70% max.	10% min.	160% (at 23°C)	Approx. 200
6 VDC	33.3	180				
12 VDC	16.7	720				
24 VDC	8.3	2,880				

● Coil: 2-Pole, Single-side Stable Type (Including models for ultrasonically cleanable)

Item Rated voltage	Rated current (mA)	Coil resistance (Ω)	Must operate voltage (V)	Must release voltage (V)	Max. voltage (V)	Power consumption (mW)
			% of rated voltage			
5 VDC	60	83.3	80% max.	10% min.	140% (at 23°C)	Approx. 300
6 VDC	50	120				
12 VDC	25	480				
24 VDC	12.5	1,920				

● Coil: Single-winding Latching Type (Including models for ultrasonically cleanable)

Item Rated voltage	Rated current (mA)	Coil resistance (Ω)	Must set voltage (V)	Must reset voltage (V)	Max. voltage (V)	Power consumption	
			% of rated voltage			Set coil (mW)	Reset coil (mW)
5 VDC	40	125	70% max.	70% max.	160% (at 23°C)	200	200
6 VDC	33.3	180					
12 VDC	16.7	720					
24 VDC	8.3	2,880					

● Coil: Double-winding Latching Type (Including models for ultrasonically cleanable)

Item Rated voltage	Rated current (mA)		Coil resistance (Ω)		Must set voltage (V)	Must reset voltage (V)	Max. voltage (V)	Power consumption	
	Set coil	Reset coil	Set coil	Reset coil	% of rated voltage			Set coil (mW)	Reset coil (mW)
5 VDC	56	56	89.2	89.2	70% max.	70% max.	130% (at 23°C)	280	280
6 VDC	46.8	46.8	128.5	128.5					
12 VDC	23.3	23.3	515	515					
24 VDC	11.7	11.7	2,060	2,060					

● Coil: Operation Indicator Model (Flux-resistant type. Do not wash down with water.)

Item Rated voltage	Rated current (mA)	Coil resistance (Ω)	Must operate voltage (V)	Must release voltage (V)	Max. voltage (V)	Power consumption (mW)
			% of rated voltage			
5 VDC	43	116	70% max.	10% min.	130% (at 23°C)	Approx. 200
12 VDC	19.7	610				Approx. 240
24 VDC	11.3	2,120				Approx. 275

Note 1. The rated current and coil resistance are measured at a coil temperature of 23°C with a tolerance of ±10%.

2. The operating characteristics are measured at a coil temperature of 23°C.

3. The "Max. voltage" is the maximum voltage that can be applied to the relay coil.

● Contacts

Item	Model	Resistive load		Inductive load (cosφ = 0.4; L/R = 7 ms)		Resistive load		Inductive load (cosφ = 0.4; L/R = 7 ms)	
		Resistive load	Inductive load (cosφ = 0.4; L/R = 7 ms)	Resistive load	Inductive load (cosφ = 0.4; L/R = 7 ms)	Resistive load	Inductive load (cosφ = 0.4; L/R = 7 ms)	Resistive load	Inductive load (cosφ = 0.4; L/R = 7 ms)
Model	G6B-1114P(-FD)(-1)-US G6BU-1114P(-FD)(-1)-US G6BK-1114P(-FD)(-1)-US G6B-1114C(-FD)-US G6BU-1114C-US G6BK-1114C(-FD)-US								
Model	G6B-1174P(-FD)(-1)-US G6B-1177P(-FD)-ND-US G6B-1174C(-FD)-US G6B-1177C(-FD)-ND-US								
Model	G6B-1184P-US								
Model	G6B-2114P(-FD)(-1)-US G6B-2214P(-FD)(-1)-US G6B-2014P(-FD)-US G6B-2114C(-FD)-US G6B-2214C(-FD)-US G6B-2014C(-FD)-US								
Contact type	Single		Single crossbar		Single				
Contact material	Ag-Alloy (Cd free)		Au-alloy + Ag (Cd free)		Ag-Alloy (Cd free)				
Rated load	5 A (3 A) at 250 VAC 5 A (3 A) at 30 VDC	2 A (2 A) at 250 VAC 2 A (2 A) at 30 VDC	8 A (5 A) at 250 VAC 8 A (5 A) at 30 VDC	2 A (2 A) at 250 VAC 2 A (2 A) at 30 VDC	2 A at 250 VAC 2 A at 30 VDC	0.5 A at 250 VAC 0.5 A at 30 VDC	5 A (3 A) at 250 VAC 5 A (3 A) at 30 VDC	1.5 A (1.5 A) at 250 VAC 1.5 A (1.5 A) at 30 VDC	
Rated carry current	5 A (5 A)		8 A (5 A)		2A		5 A (5 A)		
Max. switching voltage	380 VAC, 125 VDC								
Max. switching current	5 A (5 A)		8 A (5 A)		2A		5 A (5 A)		

Note 1. The values in the parentheses () are for -FD models only.

2. Use the -FD type for inductive load and switching load which contact roughening is small.

Characteristics

Model		G6B-1114P(-FD)(-1)-US G6B-1174P(-FD)(-1)-US G6B-1114C(-FD)-US G6B-1174C(-FD)-US	G6BU-1114P(-FD)(-1)-US G6BU-1114C-US	G6BK-1114P(-FD)(-1)-US G6BK-1114C(-FD)-US	G6B-1177P(-FD)-ND-US G6B-1177C(-FD)-ND-US	G6B-1184P-US	G6B-2114P(-FD)(-1)-US G6B-2214P(-FD)(-1)-US G6B-2014P(-FD)(-1)-US G6B-2114C(-FD)-US G6B-2214C(-FD)-US G6B-2014C(-FD)-US
Item	Classification	Single-side stable	Single-winding latching	Double-winding latching	Built-in operation indicator & surge absorption diode	Single-side stable	Single-side stable
Contact resistance *1		30 mΩ max.				50 mΩ max.	30 mΩ max.
Operate (set) time		10 ms max.					
Release (reset) time		10 ms max.					
Min. set pulse width		-	15 ms (at 23°C)		-		
Min. reset pulse width		-	15 ms (at 23°C)		-		
Insulation resistance *2		1,000 MΩ min.					
Dielectric strength	Between coil and contacts	3,000 VAC, 50/60 Hz for 1 min		2,000 VAC, 50/60 Hz for 1 min	3,000 VAC, 50/60 Hz for 1 min		
	Between contacts of the same polarity	1,000 VAC, 50/60 Hz for 1 min					
	Between contacts of different polarity	-					
	Between set and reset coils	-	250 VAC, 50/60 Hz for 1 min		-		
Impulse withstand voltage (between coil and contacts)		6 kV 1.2 × 50 μs	4.5 kV 1.2 × 50 μs		6 kV 1.2 × 50 μs	-	6 kV 1.2 × 50 μs
Vibration resistance	Destruction	10 to 55 to 10 Hz, 0.75 mm single amplitude (1.5 mm double amplitude)					
	Malfunction	10 to 55 to 10 Hz, 0.75 mm single amplitude (1.5 mm double amplitude)					
Shock resistance	Destruction	1,000 m/s ²					
	Malfunction	100 m/s ²	300 m/s ²		100 m/s ²		
Durability	Mechanical	50,000,000 operations min. (at 18,000 operations/hr)					
	Electrical	100,000 operation min. (at 1,800 operations/hr under rated load)					
Failure rate (P level) (reference value) *3		10 mA at 5 VDC				1 mA at 1 VDC	10 mA at 5 VDC
Ambient operating temperature		-25°C to 70°C (with no icing or condensation)					
Ambient operating humidity		5% to 85%					
Weight		Approx. 3.5 to 4.6 g	Approx. 3.5 g	Approx. 3.7 g	Approx. 5.4 g	Approx. 3.5 g	Approx. 4.5 g

Note 1. The values here are initial values.

2. The G6B-1177P(-FD)-ND model is flux-resistant. Do not wash it down with water.

*1. The contact resistance was measured with 1 A at 5 VDC using a voltage-drop method.

*2. Measurement conditions: The insulation resistance was measured with a 500 VDC megohmmeter at the same locations as the dielectric strength was measured. (Except the location between set/reset coil)

*3. This value was measured at a switching frequency of 120 operations/min.

Engineering Data

Maximum Switching Current

G6B-1114P-US
G6B-1174P-FD-US

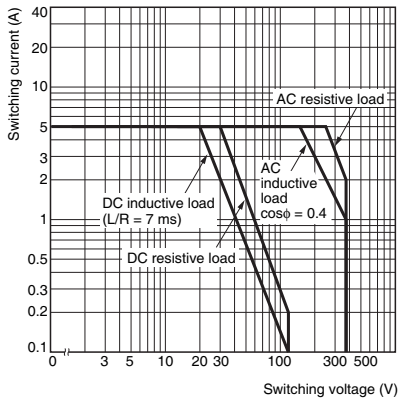

G6B-1174P-US

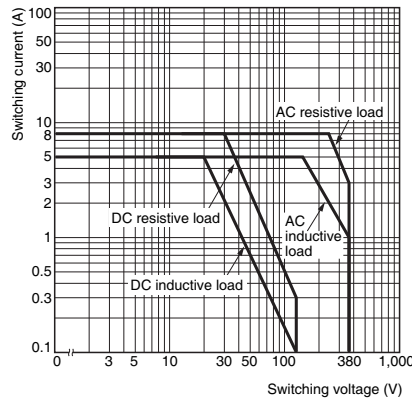

G6B-2114P-US
G6B-2214P-US
G6B-2014P-US

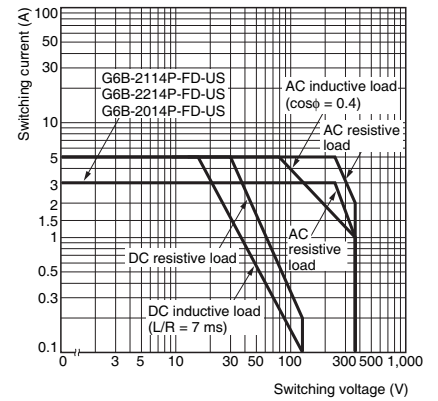

Durability

G6B-1114P-US
G6B-1174P-US
G6B-1174P-FD-US

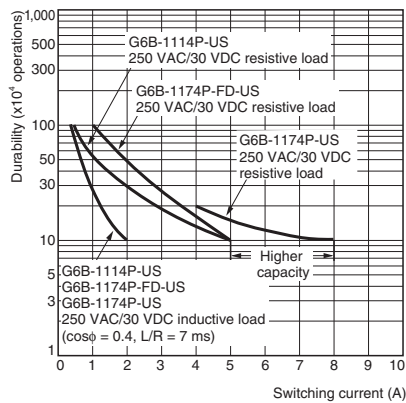

G6B-2114P(-FD)-US
G6B-2214P(-FD)-US
G6B-2014P(-FD)-US

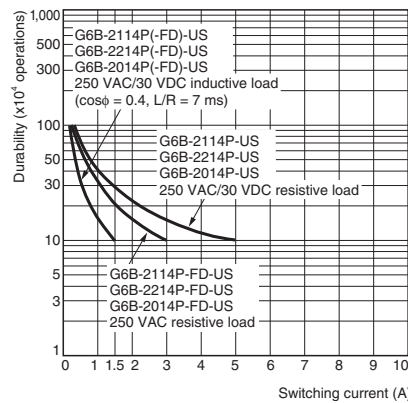

Ambient Temperature vs. Maximum Coil Voltage

G6B-1114P-US
G6B-1174P-US
G6B-1174P-FD-US

G6B-2114P-US
G6B-2214P-US
G6B-2014P-US

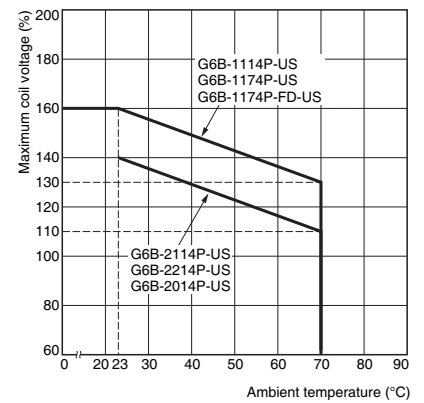

Note: The maximum coil voltage refers to the maximum value in a varying range of operating power voltage, not a continuous voltage.

Ambient Temperature vs. Must Operate and Must Release Voltage

G6B-1114P-US

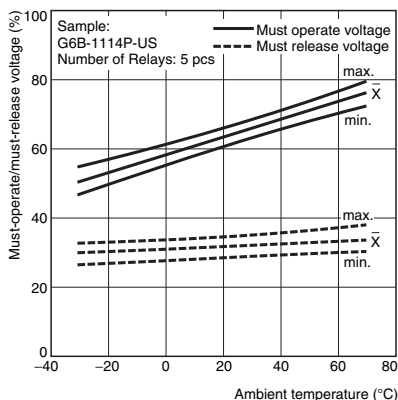

Mutual Magnetic Interference

G6B-1114P-US

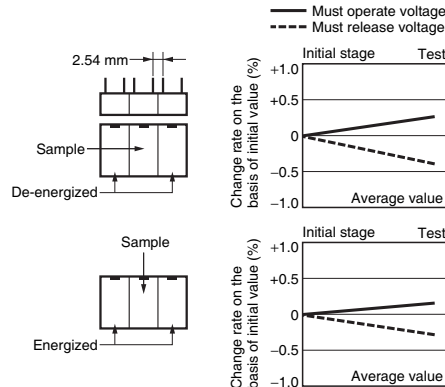

G6B-1114P-US

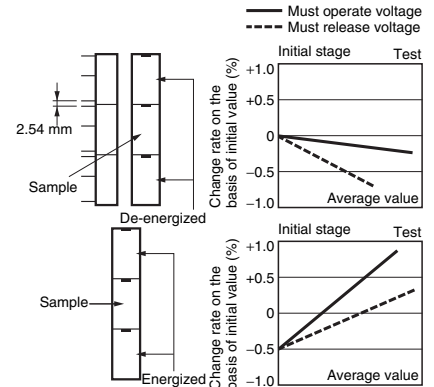

● Shock Malfunction

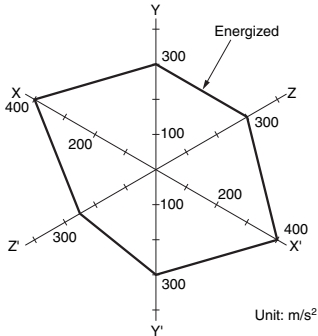

Sample: G6B-1114P-US
 Number of Relays: 12 pcs
 Test Conditions: Shock is applied in $\pm X$, $\pm Y$, and $\pm Z$ directions three times each with without energizing the Relays to check the number of malfunctions.
 Requirement: None malfunction 100 m/s²

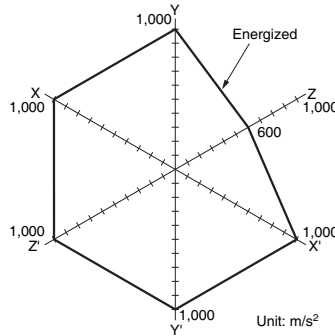
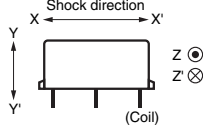

Sample: G6B-1174P-US
 G6B-1174P-FD-US
 Test Conditions: Shock is applied in $\pm X$, $\pm Y$, and $\pm Z$ directions three times each with without energizing the Relays to check the number of malfunctions.
 Requirement: None malfunction 100 m/s²

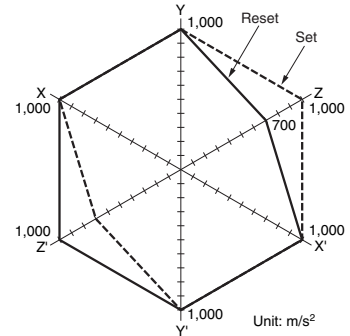
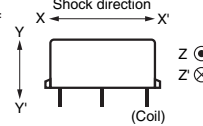

Sample: G6BK-1114P-US
 Number of Relays: 12 pcs
 Test Conditions: The value at which malfunction occurred was measured after applying shock to the test piece 3 times each in 6 directions along 3 axes.
 Standard value: 300 m/s²

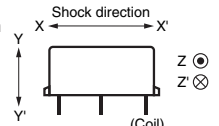

● Hot Start

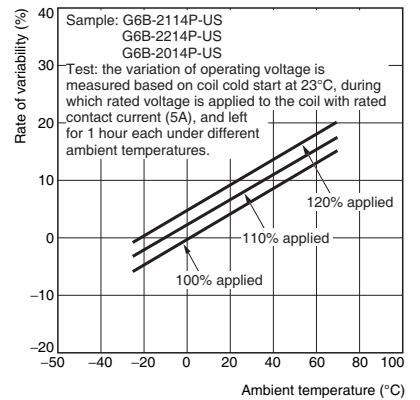
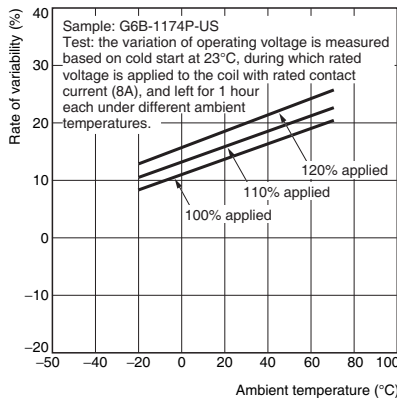
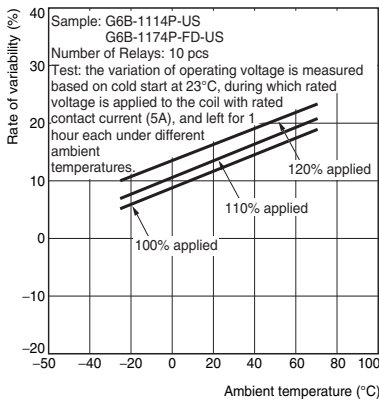

■ Dimensions

(Unit: mm)

1-pole Single-side Stable Models (SPST-NO(1a))

Straight PCB
 G6B-1114P(-FD)(-1)-US
 G6B-1184P-US

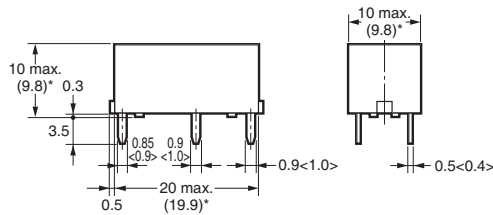
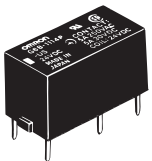

* Average value
 Dimensions in pointed brackets <> are for the Relay mounted to Socket.

PCB Mounting Holes
 (BOTTOM VIEW)
 Tolerance: ± 0.1 mm

Terminal Arrangement/
 Internal Connections
 (BOTTOM VIEW)

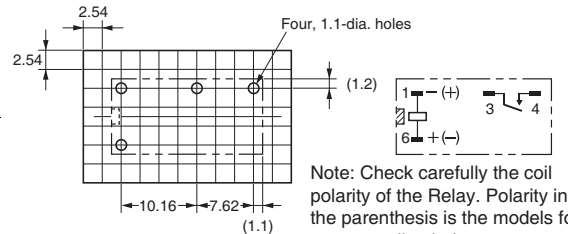

Note: Check carefully the coil polarity of the Relay. Polarity in the parenthesis is the models for reverse coil polarity.

Note: Orientation marks are indicated as follows:

Self-clinching PCB G6B-1114C(-FD)-US

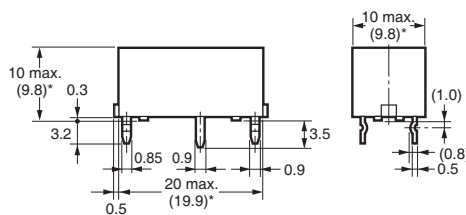
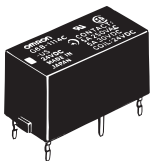

* Average value

1-pole Single-side Stable Models (SPST-NO(1a))

Straight PCB

G6B-1174P(-FD)(-1)-US

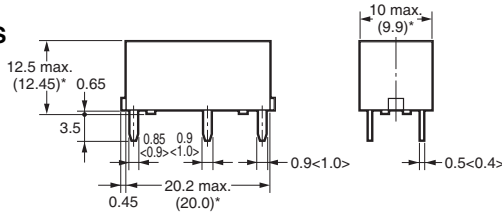
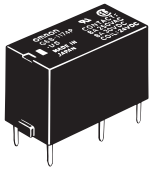

* Average value

Dimensions in pointed brackets < > are for the Relay mounted to Socket.

PCB Mounting Holes (BOTTOM VIEW)

Tolerance: ± 0.1 mm

Terminal Arrangement/ Internal Connections (BOTTOM VIEW)

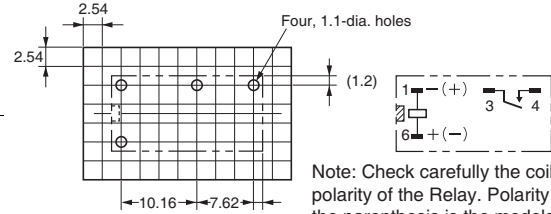

Note: Check carefully the coil polarity of the Relay. Polarity in the parenthesis is the models for reverse coil polarity.

Note: Orientation marks are indicated as follows:

Self-clinching PCB

G6B-1174C(-FD)-US

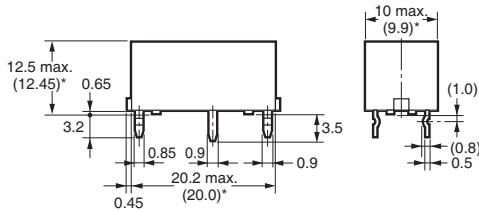
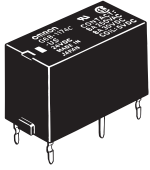

* Average value

1-pole Single-winding Latching Model (SPST-NO(1a))

Straight PCB

G6BU-1114P(-1)-US

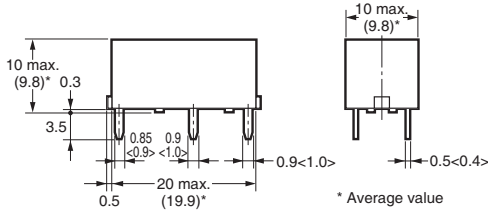
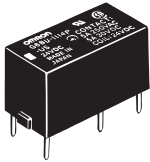

* Average value

Dimensions in pointed brackets < > are for the Relay mounted to Socket.

PCB Mounting Holes (BOTTOM VIEW)

Tolerance: ± 0.1 mm

Terminal Arrangement/ Internal Connections (BOTTOM VIEW)

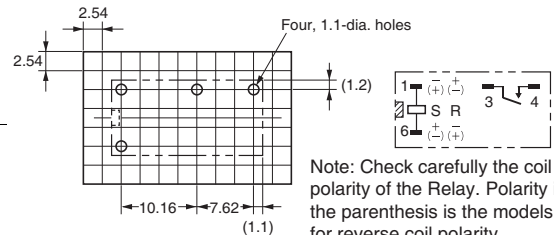

Note: Check carefully the coil polarity of the Relay. Polarity in the parenthesis is the models for reverse coil polarity.

S: Set coil
R: Reset coil

Note: Orientation marks are indicated as follows:

Self-clinching PCB

G6BU-1114C-US

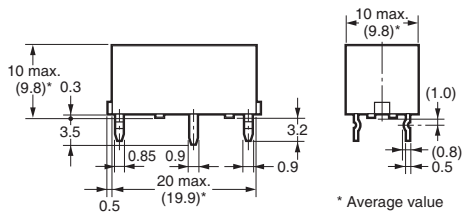
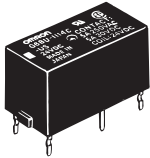

* Average value

1-pole Double-winding Latching Model (SPST-NO(1a))

Straight PCB

G6BK-1114P(-FD)(-1)-US

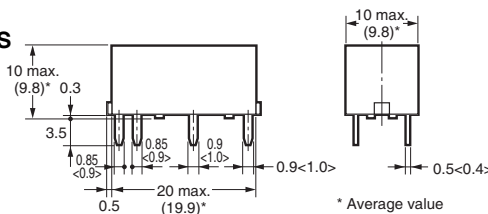
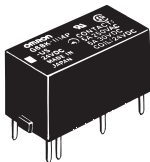

* Average value

Dimensions in pointed brackets < > are for the Relay mounted to Socket.

PCB Mounting Holes (BOTTOM VIEW)

Tolerance: ± 0.1 mm

Terminal Arrangement/ Internal Connections (BOTTOM VIEW)

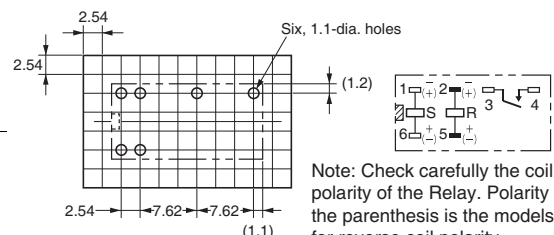

Note: Check carefully the coil polarity of the Relay. Polarity in the parenthesis is the models for reverse coil polarity.

S: Set coil
R: Reset coil

Note: Orientation marks are indicated as follows:

Self-clinching PCB

G6BK-1114C(-FD)-US

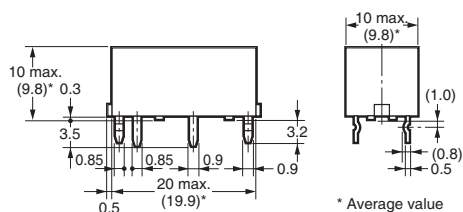
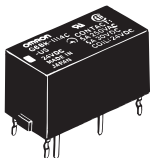

* Average value

1-pole Single-side stable Models (SPST-NO (1a)) (Built-in high capacity operation indicator & surge absorption diode)

Straight PCB

G6B-1177P(-FD)-ND-US

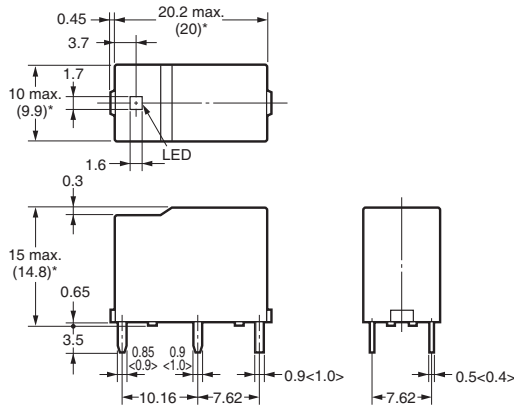
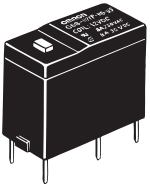

* Average value

Dimensions in pointed brackets < > are for the Relay mounted to Socket.

PCB Mounting Holes (BOTTOM VIEW)
Tolerance: ± 0.1 mm

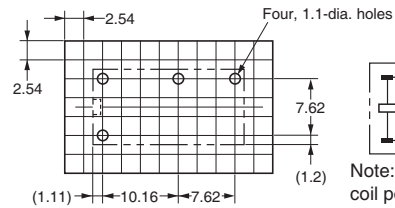

Terminal Arrangement/ Internal Connections (BOTTOM VIEW)

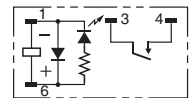

Note: Check carefully the coil polarity of the Relay.

Note: The G6B-1177P-ND-US model has a flux-resistant construction. Do not wash it down with water. Pay attention to the polarity of the coil since the LED and surge absorption diode are built-in.

Self-clinching PCB

G6B-1177C(-FD)-ND-US

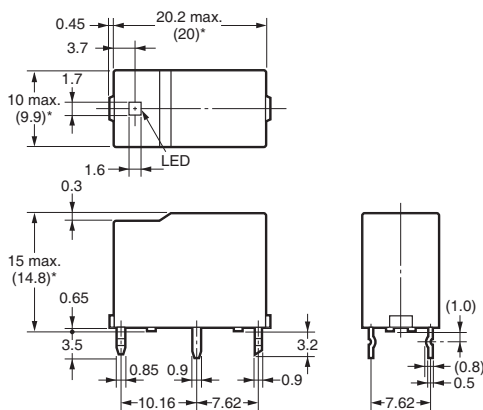
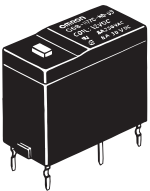

* Average value

Dimensions in pointed brackets < > are for the Relay mounted to Socket.

2-poles Single-side stable Models (SPST-NO (1a) + SPST-NC (1b), DPST-NO (2a), DPST-NC(2b))

Straight PCB

G6B-2114P(-FD)(-1)-US

G6B-2214P(-FD)(-1)-US

G6B-2014P(-FD)-US

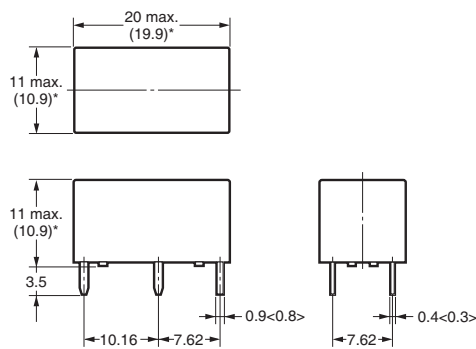
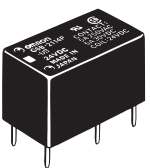

* Average value

Dimensions in pointed brackets < > are for the Relay mounted to Socket.

PCB Mounting Holes (BOTTOM VIEW)
Tolerance: ± 0.1 mm

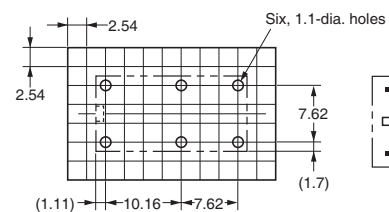

Terminal Arrangement/ Internal Connections (BOTTOM VIEW)

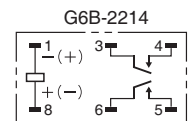
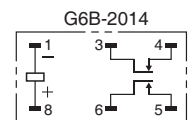
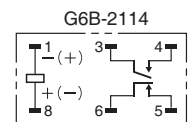

Note: Check carefully the coil polarity of the Relay. Polarity in the parenthesis is the models for reverse coil polarity.

Self-clinching PCB

G6B-2114C(-FD)-US

G6B-2214C(-FD)-US

G6B-2014C(-FD)-US

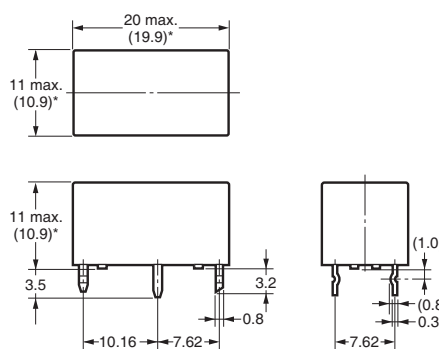
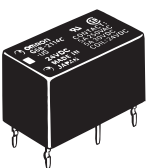

* Average value

Dimensions in pointed brackets < > are for the Relay mounted to Socket.

■Connecting Sockets Dimensions

Socket for 1-pole Single-winding Latching Model and Single-side Stable Model P6B-04P

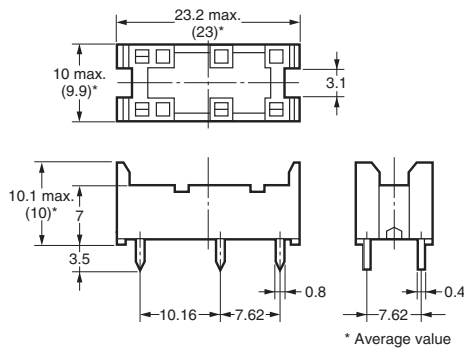
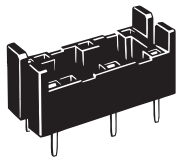

PCB Mounting Holes (BOTTOM VIEW) Tolerance: ±0.1 mm

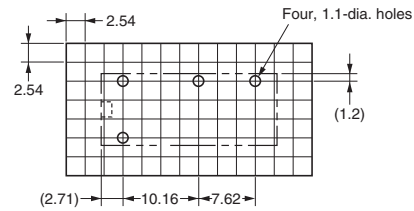

Socket for 1-pole Double-winding Latching Model P6B-06P

G
6
B

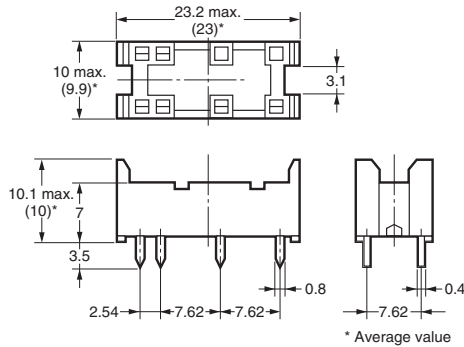
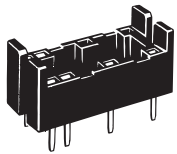

PCB Mounting Holes (BOTTOM VIEW) Tolerance: ±0.1 mm

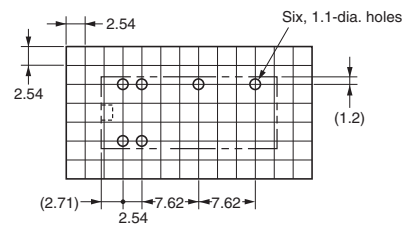

Socket for Double-pole Single-side Stable P6B-26P

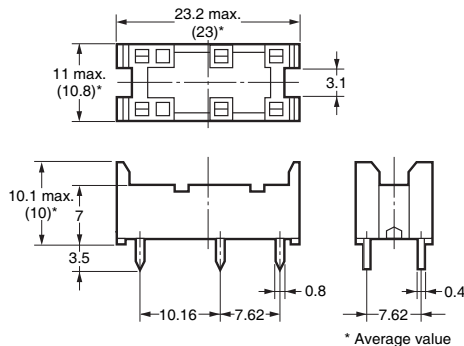
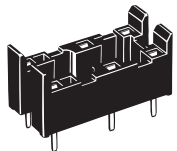

PCB Mounting Holes (BOTTOM VIEW) Tolerance: ±0.1 mm

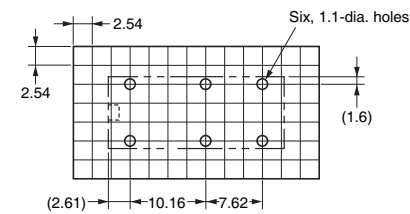

■Removal Tool

P6B-Y1

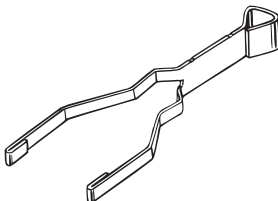

■Hold-down Clips

P6B-C2

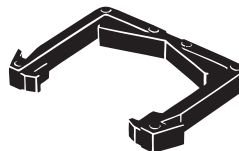

■Related Products

The G6B-4 Terminal Relay series with 4-point output is also available. For details, contact your OMRON sales representative.

Approved Standards

- The approval rating values for overseas standards are different from the performance values determined individually. Confirm the values before use.

UL Recognized:  (File No. E41643)

Model	Contact form	Coil ratings	Contact ratings	Number of test operations
G6B-1114P(-FD)(-1)-US G6B-1114C(-FD)-US	1	3 to 24 VDC	5 A, 250 VAC (General Use) 80°C	6,000
			5 A, 30 VDC (Resistive) 80°C	
			1/8HP, 250 VAC 80°C	1,000
			1/6HP, 250 VAC 80°C	
G6B-1174P(-FD)(-1)-US G6B-1174C(-FD)-US	1	3 to 24 VDC	8 A, 277 VAC (General Use) 80°C	30,000
			8 A, 30 VDC (Resistive) 80°C	
G6B-1184P-US	1	3 to 24 VDC	2 A, 250 VAC (General Use) 80°C	6,000
			2 A, 30 VDC (Resistive) 80°C	
G6B-2114P(-FD)(-1)-US G6B-2214P(-FD)(-1)-US G6B-2014P(-FD)-US G6B-2114C(-FD)-US G6B-2214C(-FD)-US G6B-2014C(-FD)-US	2	3 to 24 VDC	5 A, 250 VAC (General Use) 80°C	6,000
			5 A, 30 VDC (Resistive) 80°C	

CSA Certified:  (File No. LR31928)

Model	Contact form	Coil ratings	Contact ratings	Number of test operations
G6B-1114P(-FD)(-1)-US G6B-1114C(-FD)-US	1	3 to 24 VDC	5 A, 250 VAC (General Use) 80°C	6,000
			5 A, 30 VDC (Resistive) 80°C	
			1/6HP, 250 VAC 80°C	1,000
			360 W, 120 VAC tungsten 80°C	6,000
G6B-1174P(-FD)(-1)-US G6B-1174C(-FD)-US	1	3 to 24 VDC	8 A, 277 VAC (General Use) 80°C	30,000
			8 A, 30 VDC (Resistive) 80°C	
G6B-2114P(-FD)(-1)-US G6B-2214P(-FD)(-1)-US G6B-2014P(-FD)-US G6B-2114C(-FD)-US G6B-2214C(-FD)-US G6B-2014C(-FD)-US	2	3 to 24 VDC	5 A, 250 VAC (General Use) 80°C	6,000
			5 A, 30 VDC (Resistive) 80°C	

EN/IEC, TÜV Certified:  (Registration No. R50158246)

Model	Contact form	Coil ratings	Contact ratings	Number of test operations
G6B-1114P(-1)-US G6B-1114C-US	1	5, 6, 12, 24 VDC	5 A, 250 VAC (cosφ = 1) at 70°C	20,000
			2 A, 250 VAC (cosφ = 0.4) at 70°C	
			5 A, 30 VDC (L/R = 0 ms) at 70°C	
G6B-1174P(-1)-US G6B-1174C-US	1	5, 6, 12, 24 VDC	8 A, 250 VAC (cosφ = 1) at 70°C	
			2 A, 250 VAC (cosφ = 0.4) at 70°C	
			8 A, 30 VDC (L/R = 0 ms) at 70°C	
G6B-2114P(-1)-US G6B-2214P(-1)-US G6B-2014P-US G6B-2114C-US G6B-2214C-US G6B-2014C-US	2	5, 6, 12, 24 VDC	5 A, 250 VAC (cosφ = 1) at 70°C	
			1.5 A, 250 VAC (cosφ = 0.4) at 70°C	
			5 A, 30 VDC (L/R = 0 ms) at 70°C	
G6B-1114P(-FD)(-1)-US G6B-1114C(-FD)-US	1	5, 6, 12, 24 VDC	3 A, 250 VAC (cosφ = 1) at 70°C	10,000
			3 A, 30 VDC (L/R = 0 ms) at 70°C	
G6B-1174P(-FD)(-1)-US G6B-1174C(-FD)-US	1	5, 6, 12, 24 VDC	5 A, 250 VAC (cosφ = 1) at 70°C	
			2 A, 250 VAC (cosφ = 0.4) at 70°C	
			5 A, 30 VDC (L/R = 0 ms) at 70°C	
G6B-2114P(-FD)(-1)-US G6B-2214P(-FD)(-1)-US G6B-2014P(-FD)-US G6B-2114C(-FD)-US G6B-2214C(-FD)-US G6B-2014C(-FD)-US	2	5, 6, 12, 24 VDC	1.5 A, 250 VAC (cosφ = 0.4) at 70°C	
			3 A, 30 VDC (L/R = 0 ms) at 70°C	

■Precautions

● Please refer to “PCB Relays Common Precautions” for correct use.

Correct Use

● Mounting

- When installing more than two Relays side by side on a PCB, keep the gaps as shown below.

It may cause a malfunction if heat is not dissipated smoothly from the Relay.

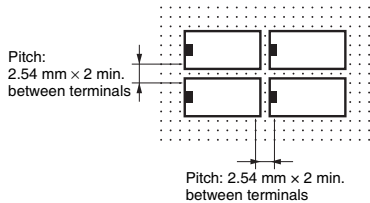

- No specified mounting direction.

● Mounting Height of Sockets and Precautions



- Hold-down clips (for mounting and removal) are also available. (For P6B-C2 model) However, it is not suitable for G6B-1174P and G6B-1177P models.
- Removal tool is also available. (For P6B-Y1 model) However, it is not suitable for G6B-1177P model.

● Inhibit Circuit of the G6B-1177P(-FD)-ND-US Model

- Do not use under conditions in which a surge is included in the power supply, such as when an inductive load is connected in parallel to the coil. Doing so will cause damage to the installed (or built-in) coil surge absorbing diode.

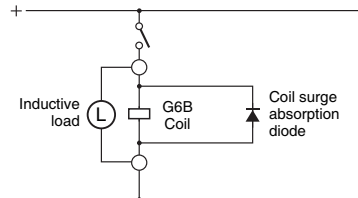

● Using SPDT contact of the SPST-NO+SPST-NC Relay

- Do not construct a circuit so that overcurrent and burning occur if the NO, NC and SPDT contacts are short-circuited with the SPST-NO+SPST-NC Relay. Arcing may generate short-circuiting between contacts if there is short-circuiting because of conversion to the MBB contact caused by asynchronous operation of the NO and NC contacts, the interval between the NO and NC contacts is small, or a large current is left open.

● Other precautions

- The P6B model has a flux-resistant construction. Do not wash it down with water.
- Perform wiring of No.1 and No. 2 of the X terminal as COM for double-winding latching as shown below. The operation stability improves by doing this.

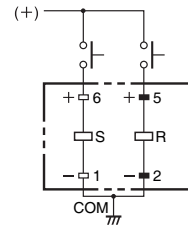



- Check carefully the coil polarity (+ and -) of the Relay G6B-1177P(-FD)-ND-US. Do not reverse the polarity when connecting. Otherwise the built-in coil surge absorption diode may be damaged.
- This Relay is a Power Relay which is suitable for power load switching. Do not use the G6B for signal purposes such as micro load switching under 10 mA.

• Application examples provided in this document are for reference only. In actual applications, confirm equipment functions and safety before using the product.
 • Consult your OMRON representative before using the product under conditions which are not described in the manual or applying the product to nuclear control systems, railroad systems, aviation systems, vehicles, combustion systems, medical equipment, amusement machines, safety equipment, and other systems or equipment that may have a serious influence on lives and property if used improperly. Make sure that the ratings and performance characteristics of the product provide a margin of safety for the system or equipment, and be sure to provide the system or equipment with double safety mechanisms.

Note: Do not use this document to operate the Unit.

Looking for pricing, stock, or lifecycle information?

Click below to explore more details on WIN SOURCE:

-  [View G6B-2114P-1-US 24VDC on WIN SOURCE](#)
-  [Omron Information](#)

Optimize Your Supply Chain with WIN SOURCE Solutions

-  Global Sourcing Solution
-  Obsolete Management
-  Cost Control Management
-  Shortage Management
-  Alternative Solution
-  Excess Inventory Management