



**THE DATASHEET OF
FP4-200-R**



FP4

High current power inductors

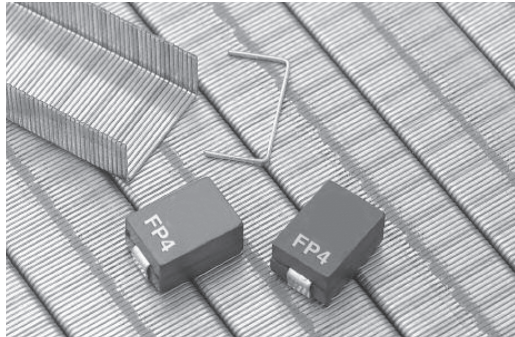

Product description

- High current carrying capacity
- Inductance range from 0.090uH to 0.200uH
- Current range 30 to 72 Amps
- 10.2 x 6.8mm footprint surface mount package in a 5.0mm height
- Ferrite core material
- Halogen free, lead free, RoHS compliant

Applications

- Servers
- Multi-phase and Vcore regulators
- Voltage Regulator Modules (VRMs)
 - Server and desktop
 - Central processing unit (CPU)
 - Graphics processing unit (GPU)
 - Application specific integrated circuit (ASIC)
 - High power density
- Battery power systems
- Graphics cards

Environmental data

- Storage temperature range (component): -40°C to +155°C
- Operating temperature range: -45°C to +155°C (Ambient plus self temperature rise)
- Solder reflow temperature: J-STD-020D compliant



Product specifications

Part number ⁵	OCL ¹ (μH) ±15%	I _{rms} ² (amps)	I _{sat} ³ (amps)	DCR (Ω) typical @ 20°C	DCR (Ω) maximum @ 20°C	Volt-μsec ⁴ (V-μsec)
FP4-100-R	0.100	40	64	0.00038	0.00065	1.33
FP4-120-R	0.120	40	54	0.00038	0.00065	1.33
FP4-150-R	0.150	40	42	0.00038	0.00065	1.33
FP4-200-R	0.200	40	30	0.00038	0.00065	1.33

1. Open Circuit Inductance (OCL) Test parameters: 1MHz, 0.100Vrms, 0.0Adc @20°C.
2. I_{rms}: DC current for an approximate ΔT of 40°C without core loss. Derating is necessary for AC currents. PCB layout, trace thickness and width, airflow, and proximity of other heat generating components will affect the temperature rise. It is recommended that the temperature of the part not exceed 155°C.
3. I_{sat} : Peak current for approximately 30% rolloff @ +20°C.
4. Applied Volt-Time product (V-μs) across the inductor. This value represents the applied V-μs at 500kHz necessary to generate a core loss equal to 10% of the total losses for 40°C temperature rise.
5. Part Number Definition: FP4-xxx-R
FP4 = Product code and size
xxx= Inductance value in uH, R= decimal point
-R suffix = RoHS compliant

Part number ⁵	OCL ¹ (μH) ±15%	I _{rms} ² (amps)	I _{sat} ³ (amps)	DCR (mΩ) @25°C	Volt-μsec ⁴ (V-μsec)
FP4-090SK-R	0.090	33	72	0.423-0.517	1.33

1. Open Circuit Inductance (OCL) Test parameters: 100kHz, 1.0Vrms, 0.0Adc @25°C.
2. I_{rms}: DC current for an approximate ΔT of 40°C without core loss. Derating is necessary for AC currents. PCB layout, trace thickness and width, airflow, and proximity of other heat generating components will affect the temperature rise. It is recommended that the temperature of the part not exceed 155°C.
3. I_{sat} : Peak current for approximately 20% rolloff @ +25°C.
4. Applied Volt-Time product (V-μs) across the inductor. This value represents the applied V-μs at 500kHz necessary to generate a core loss equal to 10% of the total losses for 40°C temperature rise.
5. Part Number Definition: FP4-xxxSK-R
FP4, SK = Product code and size
xxx= Inductance value in uH, R= decimal point
-R suffix = RoHS compliant

Dimensions—mm

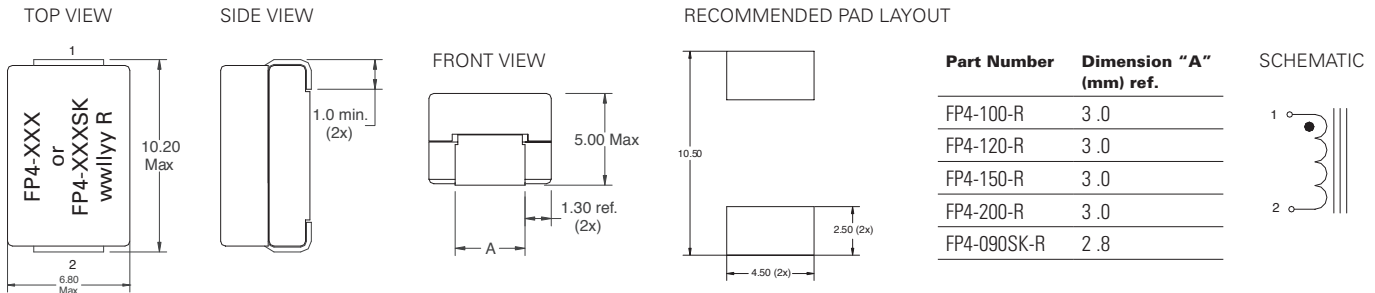

Part marking:

FP4-xxx (FP4=Product code and size),(xxx=inductance value in uH, R=decimal point)
 FP4-xxxSK (FP4, SK=Product code and size),(xxx=inductance value in uH, R=decimal point)
 wwllly = date code, R = revision level
 Tolerances are ±0.15 millimeters unless stated otherwise
 PCB tolerances are ±0.2 millimeters unless stated otherwise
 Do not route traces or vias underneath the inductor

Packaging information (mm)

Supplied in tape and reel packaging, 900 parts per 13" diameter reel.

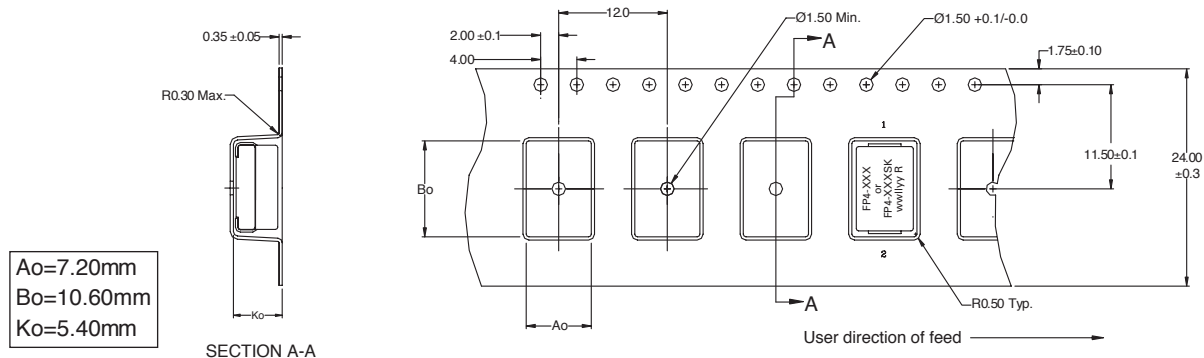

Inductance characteristics

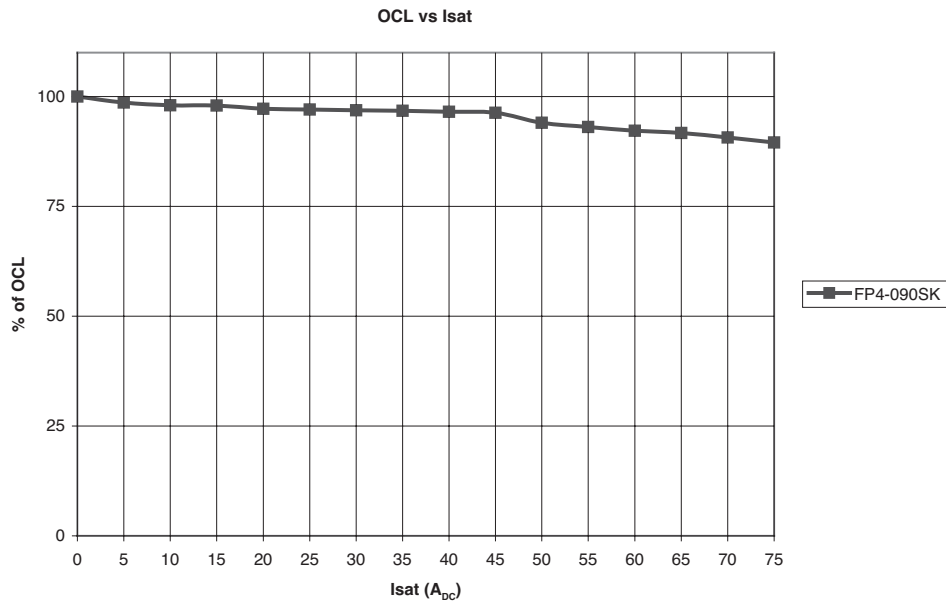
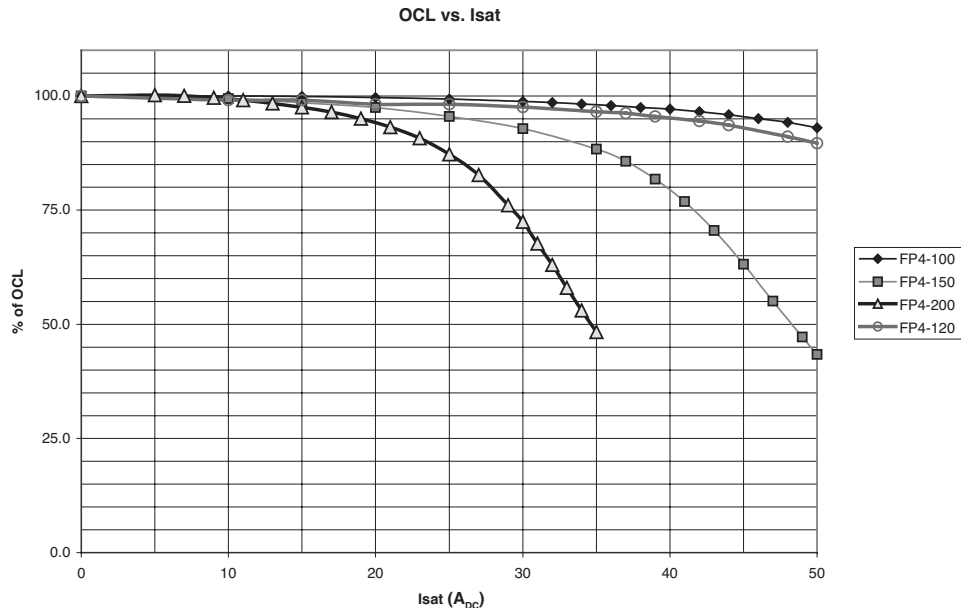

Core loss

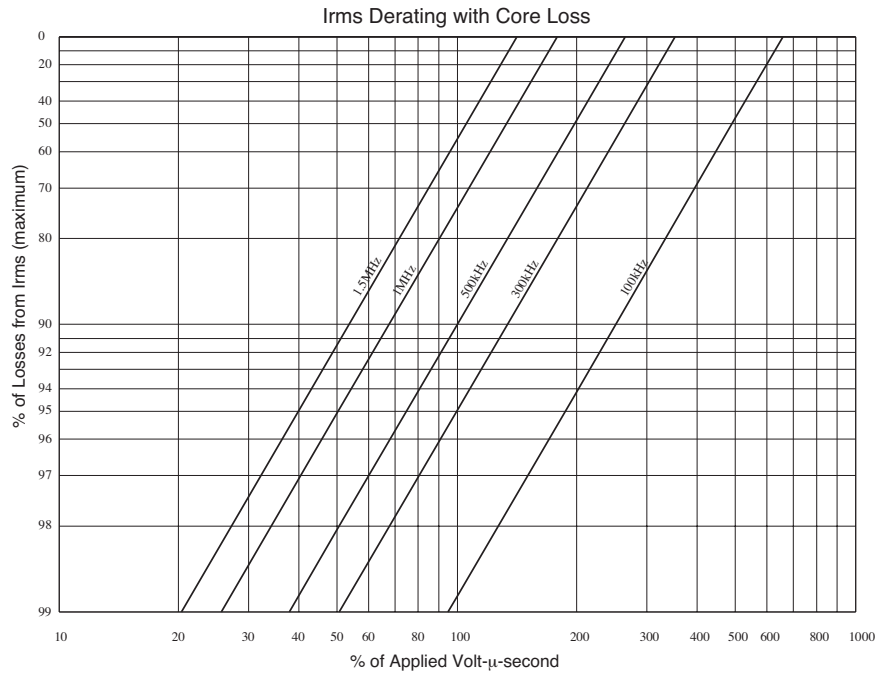

Solder reflow profile

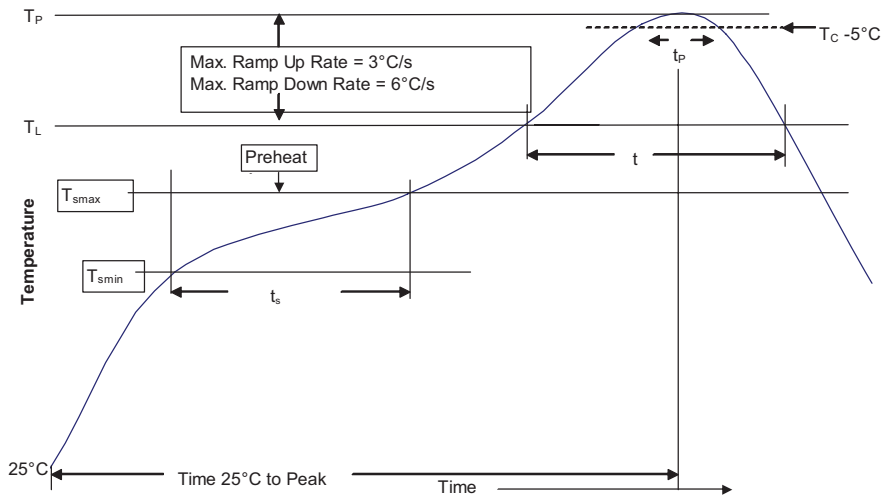

Table 1 - Standard SnPb Solder (T_C)

Package Thickness	Volume mm ³ <350	Volume mm ³ ≥350
<2.5mm)	235°C	220°C
≥2.5mm	220°C	220°C

Table 2 - Lead (Pb) Free Solder (T_C)

Package Thickness	Volume mm ³ <350	Volume mm ³ 350 - 2000	Volume mm ³ >2000
<1.6mm	260°C	260°C	260°C
1.6 – 2.5mm	260°C	250°C	245°C
>2.5mm	250°C	245°C	245°C

Reference JEDEC J-STD-020D

Profile Feature	Standard SnPb Solder	Lead (Pb) Free Solder
Preheat and Soak		
• Temperature min. (T _{smin})	100°C	150°C
• Temperature max. (T _{smax})	150°C	200°C
• Time (T _{smin} to T _{smax}) (t _s)	60-120 Seconds	60-120 Seconds
Average ramp up rate T _{smax} to T _p	3°C/ Second Max.	3°C/ Second Max.
Liquidous temperature (T _L)	183°C	217°C
Time at liquidous (t _L)	60-150 Seconds	60-150 Seconds
Peak package body temperature (T _p)*	Table 1	Table 2
Time (t _p)** within 5 °C of the specified classification temperature (T _C)	20 Seconds**	30 Seconds**
Average ramp-down rate (T _p to T _{smax})	6°C/ Second Max.	6°C/ Second Max.
Time 25°C to Peak Temperature	6 Minutes Max.	8 Minutes Max.

* Tolerance for peak profile temperature (T_p) is defined as a supplier minimum and a user maximum.
 ** Tolerance for time at peak profile temperature (t_p) is defined as a supplier minimum and a user maximum.

Life Support Policy: Eaton does not authorize the use of any of its products for use in life support devices or systems without the express written approval of an officer of the Company. Life support systems are devices which support or sustain life, and whose failure to perform, when properly used in accordance with instructions for use provided in the labeling, can be reasonably expected to result in significant injury to the user.

Eaton reserves the right, without notice, to change design or construction of any products and to discontinue or limit distribution of any products. Eaton also reserves the right to change or update, without notice, any technical information contained in this bulletin.

Eaton
Electronics Division
 1000 Eaton Boulevard
 Cleveland, OH 44122
 United States
 www.eaton.com/elx



© 2015 Eaton
 All Rights Reserved
 Printed in USA
 Publication No. 4119
 December 2015



Eaton is a registered trademark.
 All other trademarks are property of their respective owners.

Looking for pricing, stock, or lifecycle information?

Click below to explore more details on WIN SOURCE:

-  [View FP4-200-R on WIN SOURCE](#)
-  [Eaton Bussmann Information](#)

Optimize Your Supply Chain with WIN SOURCE Solutions

-  Global Sourcing Solution
-  Obsolete Management
-  Cost Control Management
-  Shortage Management
-  Alternative Solution
-  Excess Inventory Management