



**THE DATASHEET OF  
FMS6407MTF20X**



# FMS6407

## Triple Video Drivers with Selectable HD/Progressive/SD/Bypass Filters

### Features

- Three video anti-aliasing or reconstruction filters
- 2:1 Mux inputs for YPbPr / RGB or YPbPr / YC-CV inputs
- Supports D1, D2, D3 and D4 video D-connector (EIAJ CP-4120)
- Selectable 8MHz/15MHz/30MHz 6th order filters plus bypass for SD (480i), Progressive (480p) and HD (1080i/ 720p)
- AC-coupled inputs include DC restore /bias circuitry
- All outputs can drive AC or DC coupled 75Ω loads and provide either 0dB or 6dB of gain
- 0.26% differential gain, 0.11° differential phase
- Lead-free packaging

### Applications

- Progressive scan
- Cable set top boxes
- Satellite set top boxes
- DVD players
- HDTV
- Personal Video Recorders (PVR)
- Video On Demand (VOD)

### Description

The FMS6407 offers comprehensive filtering for TV, set top box or DVD applications. This part consists of a triple 6th order filter with selectable 30MHz, 15MHz, or 8MHz cutoff frequencies. The filters may also be bypassed so that the bandwidth is limited only by the output amplifiers.

A 2 to 1 multiplexer is provided on each filter channel. The triple filters are intended for YPbPr, RGB and YC-CV signals. The DC clamp levels are set according to the input mux selection and the CV\_SEL control input. YPbPr sync tips are clamped to 250mV, 1.125V and 1.125V respectively while RGB sync tips are all clamped to 250mV. CV mode clamps Y and CV to 250mV while C is clamped to 1.125V. Sync clamp timing can be derived from the Y or Green input channel or from the external SYNC\_IN pin.

All channels nominally accept AC coupled 1Vpp signals. Selectable 0dB or 6dB gain allows the outputs to drive 1Vpp or 2Vpp signals into AC or DC coupled terminated loads with a 1Vpp input. Input signals cannot exceed 1.5Vpp and outputs cannot exceed 2.5Vpp.

The FMS6407 draws 525mW from a single 5.0V supply.

### Functional Block Diagram

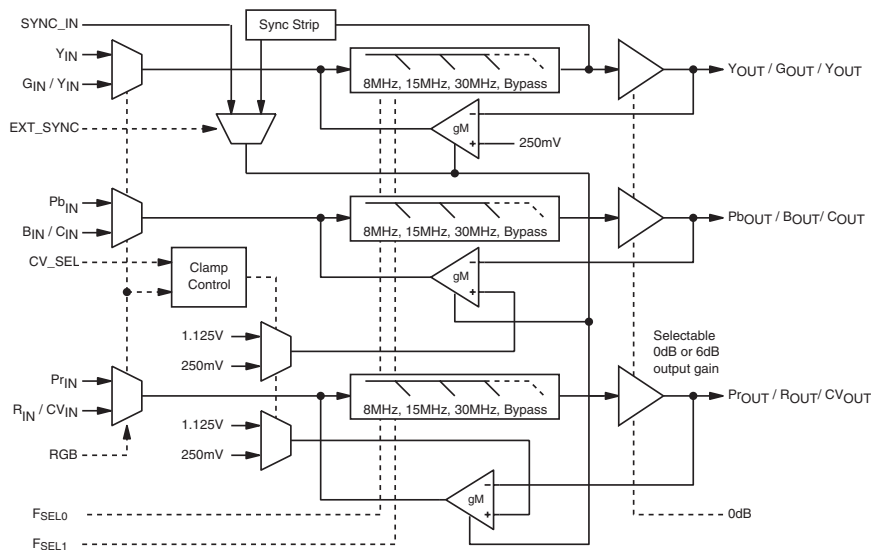

## DC Electrical Specifications

( $T_C = 25^\circ\text{C}$ ,  $V_i = 1V_{pp}$ ,  $V_{CC} = 5.0V$ , all inputs AC coupled with  $0.1\mu\text{F}$ , all outputs AC coupled with  $220\mu\text{F}$  into  $150\Omega$ , referenced to  $400\text{kHz}$ ; unless otherwise noted)

| Symbol       | Parameter                       | Conditions  | Min | Typ   | Max      | Units    |
|--------------|---------------------------------|---|-----|-------|----------|----------|
| $I_{CC}$     | Supply Current <sup>1</sup>     | $V_{CC}$ no load  |     | 105   | 130      | mA       |
| $V_i$        | Input Voltage Max               |   |     | 1.5   |          | $V_{pp}$ |
| $V_{il}$     | Digital Input Low <sup>1</sup>  | $F_{SEL1}$ , $F_{SEL2}$ , RGB, 0dB, EXT_SYNC, CV_SEL, SYNC_IN | 0   |       | 0.8      | V        |
| $V_{ih}$     | Digital Input High <sup>1</sup> | $F_{SEL1}$ , $F_{SEL2}$ , RGB, 0dB, EXT_SYNC, CV_SEL, SYNC_IN | 2.4 |       | $V_{CC}$ | V        |
| $V_{CLAMP1}$ | Output Clamp Voltage            | R,G,B,Y,CV  |     | 250   |          | mV       |
| $V_{CLAMP2}$ | Output Clamp Voltage            | Pb,Pr,C   |     | 1.125 |          | V        |
| PSRR         | Power Supply Rejection Ratio    | DC (all channels)   |     | -40   |          | dB       |

## Standard Definition Electrical Specifications

( $T_C = 25^\circ\text{C}$ ,  $V_i = 1V_{pp}$ ,  $V_{CC} = 5.0V$ ,  $F_{SEL0} = 0$ ,  $F_{SEL1} = 0$ , gain = 6dB,  $R_{SOURCE} = 37.5\Omega$ , all inputs AC coupled with  $0.1\mu\text{F}$ , all outputs AC coupled with  $220\mu\text{F}$  into  $150\Omega$ , referenced to  $400\text{kHz}$ ; unless otherwise noted)

| Symbol        | Parameter                                      | Conditions   | Min  | Typ  | Max | Units         |
|---------------|--|--|------|------|-----|---------------|
| $AV_{SD}$     | SD Gain, 0dB = '0' <sup>1</sup>                | All Channels SD Mode   | 5.6  | 6.0  | 6.4 | dB            |
| $AV_{SD}$     | SD Gain, 0dB = '1' <sup>1</sup>                | All Channels SD Mode   | -0.4 | 0    | 0.4 | dB            |
| $f_{1dBSD}$   | -1dB Bandwidth for SD <sup>1</sup>             | All Channels   | 5.5  | 6.75 |     | MHz           |
| $f_{CSD}$     | -3dB Bandwidth for SD                          | All Channels   |      | 8.2  |     | MHz           |
| $f_{SBSB}$    | Attenuation: SD (Stopband Reject) <sup>1</sup> | All Channels at $f = 27\text{MHz}$                             | 40   | 56   |     | dB            |
| dG            | Differential Gain                              | All Channels   |      | 0.26 |     | %             |
| d $\theta$    | Differential Phase                             | All Channels   |      | 0.11 |     | °             |
| THD           | Output Distortion (All Channels)               | $V_{out} = 1.8V_{pp}$ at 1MHz                                  |      | 0.4  |     | %             |
| $X_{TALK}$    | Crosstalk (Channel-to-Channel)                 | at 1.0MHz  |      | -65  |     | dB            |
| $IN_{MUXISO}$ | $IN_{MUX}$ Isolation                           | at 1.0MHz  |      | -70  |     | dB            |
| SNR           | Signal-to-Noise Ratio                          | All Channels, NTC-7 Weighting, 4.2MHz lowpass, 100kHz Highpass |      | 73   |     | dB            |
| $t_{pdSD}$    | Propagation Delay for SD                       | Delay from Input to Output at 4.5MHz                           |      | 80   |     | ns            |
| T1            | SYNC to SYNC_IN Delay                          |  |      | 10   |     | ns            |
| T2            | SYNC_IN Min Pulse Width                        |  |      | 4    |     | $\mu\text{s}$ |

## Progressive Scan (PS) Electrical Specifications

( $T_C = 25^\circ\text{C}$ ,  $V_i = 1V_{pp}$ ,  $V_{CC} = 5.0V$ ,  $F_{SEL0} = 1$ ,  $F_{SEL1} = 0$ , gain = 6dB,  $R_{SOURCE} = 37.5\Omega$ , all inputs AC coupled with  $0.1\mu\text{F}$ , all outputs AC coupled with  $220\mu\text{F}$  into  $150\Omega$ , referenced to  $400\text{kHz}$ ; unless otherwise noted)

| Symbol      | Parameter                          | Conditions           | Min  | Typ  | Max | Units |
|-------------|------------------------------------|----------------------|------|------|-----|-------|
| $AV_{PS}$   | PS Gain, 0dB = '0' <sup>1</sup>    | All Channels PS Mode | 5.6  | 6.0  | 6.4 | dB    |
| $AV_{PS}$   | PS Gain, 0dB = '1' <sup>1</sup>    | All Channels PS Mode | -0.4 | 0    | 0.4 | dB    |
| $f_{1dBPS}$ | -1dB Bandwidth for PS <sup>1</sup> | All Channels         | 10   | 13.5 |     | MHz   |

**Note:**

1. 100% tested at  $25^\circ\text{C}$ .

## Progressive Scan (PS) Electrical Specifications (Continued)

( $T_C = 25^\circ\text{C}$ ,  $V_i = 1V_{pp}$ ,  $V_{CC} = 5.0V$ ,  $F_{SEL0} = 1$ ,  $F_{SEL1} = 0$ , gain = 6dB,  $R_{SOURCE} = 37.5\Omega$ , all inputs AC coupled with  $0.1\mu\text{F}$ , all outputs AC coupled with  $220\mu\text{F}$  into  $150\Omega$ , referenced to 400kHz; unless otherwise noted)

| Symbol     | Parameter                                      | Conditions                          | Min | Typ | Max | Units         |
|------------|--|-------------------------------------|-----|-----|-----|---------------|
| $f_{CPS}$  | -3dB Bandwidth for PS                          | All Channels                        |     | 15  |     | MHz           |
| $f_{SBPS}$ | Attenuation: PS (Stopband Reject) <sup>1</sup> | All Channels at $f = 54\text{MHz}$  | 40  | 48  |     | dB            |
| $t_{pdPS}$ | Propagation Delay for PS                       | Delay from Input to Output at 10MHz |     | 45  |     | ns            |
| T1         | SYNC to SYNC_IN Delay                          |                                     |     | 10  |     | ns            |
| T2         | SYNC_IN Min Pulse Width                        |                                     |     | 2   |     | $\mu\text{s}$ |

## High Definition Electrical Specifications

( $T_C = 25^\circ\text{C}$ ,  $V_i = 1V_{pp}$ ,  $V_{CC} = 5.0V$ ,  $F_{SEL0} = 0$ ,  $F_{SEL1} = 1$ , gain = 6dB,  $R_{SOURCE} = 37.5\Omega$ , all inputs AC coupled with  $0.1\mu\text{F}$ , all outputs AC coupled with  $220\mu\text{F}$  into  $150\Omega$ , referenced to 400kHz; unless otherwise noted)

| Symbol      | Parameter                                      | Conditions                            | Min  | Typ | Max | Units         |
|-------------|--|---------------------------------------|------|-----|-----|---------------|
| $AV_{HD}$   | HD Gain, 0dB = '0' <sup>1</sup>                | All Channels HD Mode                  | 5.6  | 6.0 | 6.4 | dB            |
| $AV_{HD}$   | HD Gain, 0dB = '1' <sup>1</sup>                | All Channels HD Mode                  | -0.4 | 0   | 0.4 | dB            |
| $f_{1dBHD}$ | -1dB Bandwidth for HD <sup>1</sup>             | All Channels                          | 20   | 28  |     | MHz           |
| $f_{CHD}$   | -3dB Bandwidth for HD                          | All Channels                          |      | 32  |     | MHz           |
| $f_{SBHD}$  | Attenuation: HD (Stopband Reject) <sup>1</sup> | All Channels at $f = 74.25\text{MHz}$ | 30   | 40  |     | dB            |
| $t_{pdHD}$  | Propagation Delay for HD                       | Delay from Input to Output at 20MHz   |      | 26  |     | ns            |
| T1          | SYNC to SYNC_IN Delay                          |                                       |      | 10  |     | ns            |
| T2          | SYNC_IN Min Pulse Width                        |                                       |      | 1.5 |     | $\mu\text{s}$ |

## Bypass (Wide Bandwidth) Electrical Specifications

( $T_C = 25^\circ\text{C}$ ,  $V_i = 1V_{pp}$ ,  $V_{CC} = 5.0V$ ,  $F_{SEL0} = 1$ ,  $F_{SEL1} = 1$ , gain = 6dB,  $R_{SOURCE} = 37.5\Omega$ , all inputs AC coupled with  $0.1\mu\text{F}$ , all outputs AC coupled with  $220\mu\text{F}$  into  $150\Omega$ , referenced to 400kHz; unless otherwise noted)

| Symbol      | Parameter                       | Conditions                          | Min  | Typ | Max | Units |
|-------------|---------------------------------|-------------------------------------|------|-----|-----|-------|
| $AV_{WB}$   | WB Gain, 0dB = '0' <sup>1</sup> | All Channels WB Mode                | 5.6  | 6.0 | 6.4 | dB    |
| $AV_{WB}$   | WB Gain, 0dB = '1' <sup>1</sup> | All Channels WB Mode                | -0.4 | 0   | 0.4 | dB    |
| $f_{1dBWB}$ | -1dB Bandwidth for WB           | All Channels                        |      | 50  |     | MHz   |
| $f_{CWB}$   | -3dB Bandwidth for WB           | All Channels                        |      | 80  |     | MHz   |
| $t_{pdWB}$  | Propagation Delay for WB        | Delay from Input to Output at 20MHz |      | 10  |     | ns    |

**Note:**

1. 100% tested at 25°C.

## Absolute Maximum Ratings (beyond which the device may be damaged)

| Parameter                                       | Min  | Max            | Units |
|---|------|----------------|-------|
| DC Supply Voltage                               | -0.3 | 6              | V     |
| Analog and Digital I/O                          | -0.3 | $V_{CC} + 0.3$ | V     |
| Output Current, Any One Channel (Do not exceed) |      | 60             | mA    |

**Note:**

Functional operation under any of these conditions is NOT implied. Performance and reliability are guaranteed only if operating conditions are not exceeded.

## Reliability Information

| Parameter   | Min | Typ  | Max | Units |
|---|-----|------|-----|-------|
| Junction Temperature                                |     |      | 150 | °C    |
| Storage Temperature Range                           | -65 |      | 150 | °C    |
| Lead Temperature (Soldering, 10s)                   |     |      | 300 | °C    |
| Thermal Resistance ( $\theta_{JA}$ ), TSSOP-20      |     | 74   |     | °C/W  |
| Thermal Resistance ( $\theta_{JA}$ ), ePAD TSSOP-20 |     | 37.6 |     | °C/W  |

**Note:**

Package thermal resistance ( $\theta_{JA}$ ), JEDEC standard multi-layer test boards, still air.

## Recommended Operating Conditions

| Parameter                                | Min  | Typ | Max  | Units    |
|--|------|-----|------|----------|
| Operating Temperature Range              | 0    |     | 70   | °C       |
| $V_{CC}$ Range                           | 4.75 | 5.0 | 5.25 | V        |
| Input Source Resistance ( $R_{SOURCE}$ ) |      |     | 150  | $\Omega$ |

### Standard Definition Typical Performance Characteristics

( $T_C = 25^\circ\text{C}$ ,  $V_i = 1V_{pp}$ ,  $V_{CC} = 5.0V$ ,  $F_{SEL0} = 0$ ,  $F_{SEL1} = 0$ , gain = 6dB,  $R_{SOURCE} = 37.5\Omega$ , all inputs AC coupled with  $0.1\mu\text{F}$ , all outputs AC coupled with  $220\mu\text{F}$  into  $150\Omega$ , referenced to 400kHz; unless otherwise noted)

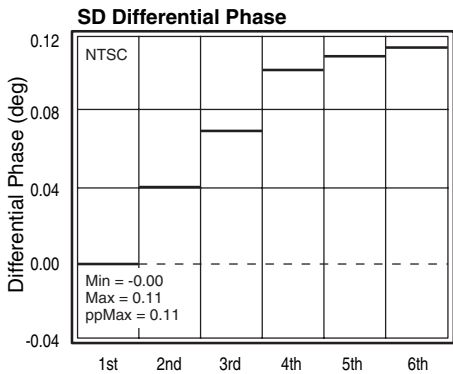
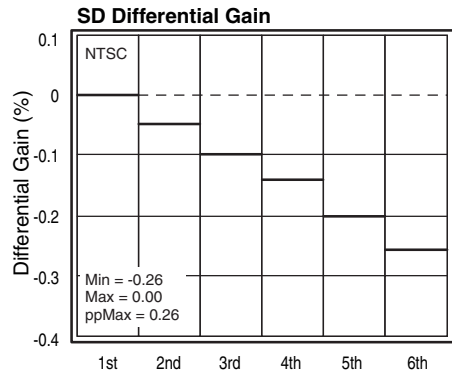
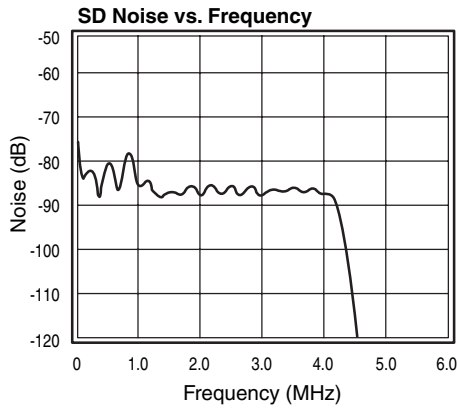
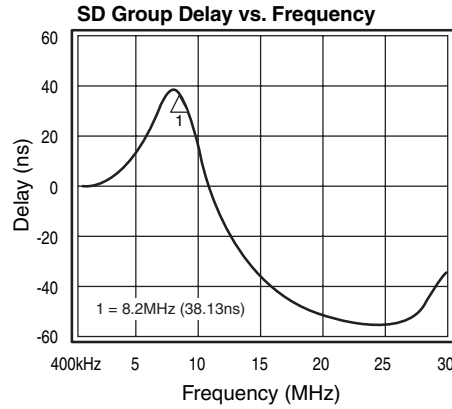
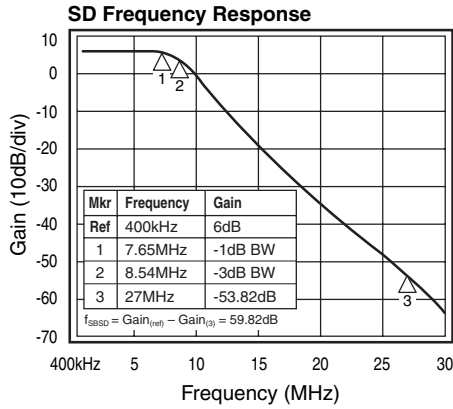

### Progressive Scan Typical Performance Characteristics

( $T_C = 25^\circ\text{C}$ ,  $V_i = 1V_{pp}$ ,  $V_{CC} = 5.0V$ ,  $F_{SEL0} = 1$ ,  $F_{SEL1} = 0$ , gain = 6dB,  $R_{SOURCE} = 37.5\Omega$ , all inputs AC coupled with  $0.1\mu\text{F}$ , all outputs AC coupled with  $220\mu\text{F}$  into  $150\Omega$ , referenced to 400kHz; unless otherwise noted)

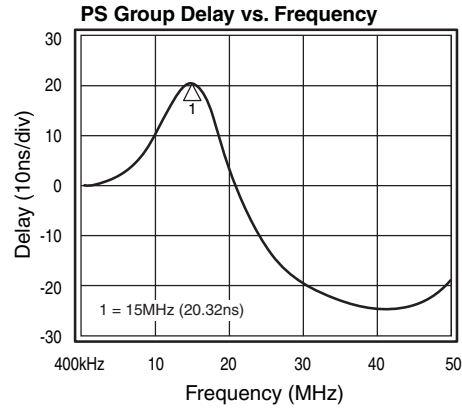
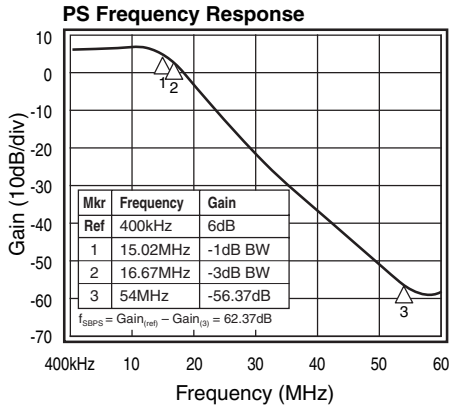

### High Definition Typical Performance Characteristics

( $T_C = 25^\circ\text{C}$ ,  $V_i = 1V_{pp}$ ,  $V_{CC} = 5.0V$ ,  $F_{SEL0} = 0$ ,  $F_{SEL1} = 1$ , gain = 6dB,  $R_S = 37.5\Omega$ , all inputs AC coupled with  $0.1\mu\text{F}$ , all outputs AC coupled with  $220\mu\text{F}$  into  $150\Omega$ , referenced to 400kHz; unless otherwise noted)

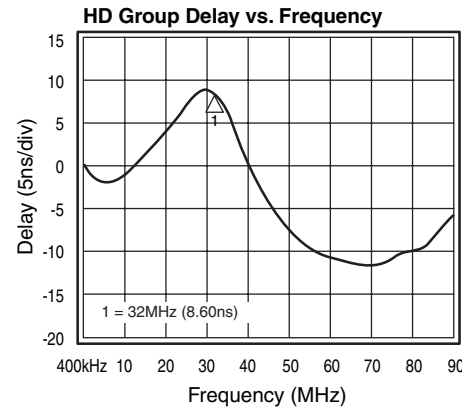
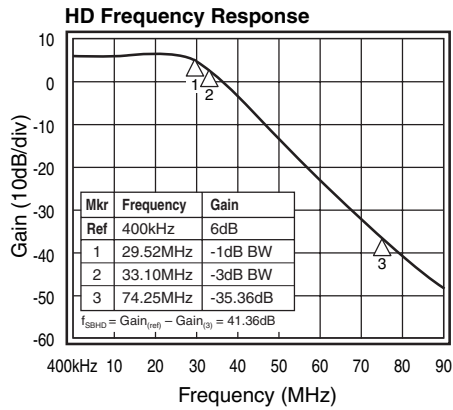

### Bypass (Wide Bandwidth) Typical Performance Characteristics

( $T_C = 25^\circ\text{C}$ ,  $V_i = 1V_{pp}$ ,  $V_{CC} = 5.0V$ ,  $F_{SEL0} = 1$ ,  $F_{SEL1} = 1$ , gain = 6dB,  $R_{SOURCE} = 37.5\Omega$ , all inputs AC coupled with  $0.1\mu\text{F}$ , all outputs AC coupled with  $220\mu\text{F}$  into  $150\Omega$ , referenced to 400kHz; unless otherwise noted)

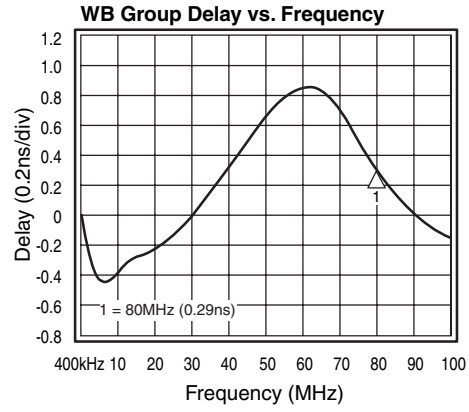
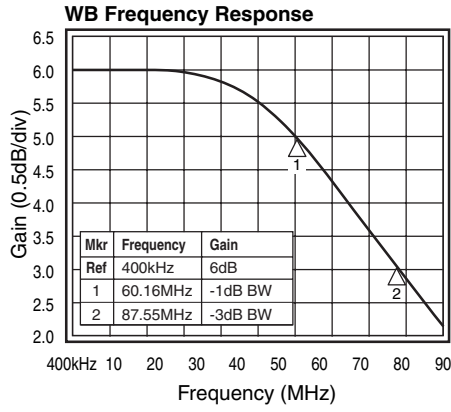

## Pin Configuration

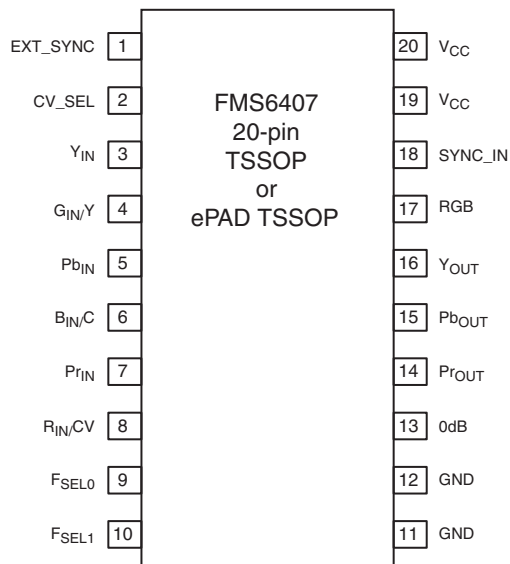

| Pin# | Pin      | Type   | Description  |
|------|----------|--------|--|
| 1    | EXT_SYNC | Input  | Selects the external SYNC_IN signal when set to logic '1', do not float                            |
| 2    | CV_SEL   | Input  | Selects CV mode when set to logic '1' (sets C clamp to 1.125V and CV clamp to 250mV), do not float |
| 3    | Y_IN     | Input  | Y (Luminance) input may be connected to a signal which includes sync                               |
| 4    | G_IN     | Input  | Green or Y input   |
| 5    | Pb_IN    | Input  | Pb input   |
| 6    | B_IN     | Input  | Blue or C (Chrominance) input  |
| 7    | Pr_IN    | Input  | Pr input   |
| 8    | R_IN     | Input  | Red or CV (Composite Video) input  |
| 9    | F_SEL0   | Input  | Selects filter corner frequency or bypass, see table, do not float                                 |
| 10   | F_SEL1   | Input  | Selects filter corner frequency or bypass, see table, do not float                                 |
| 11   | GND      | Input  | Must be tied to Ground, do not float   |
| 12   | GND      | Input  | Must be tied to Ground, do not float   |
| 13   | 0dB      | Input  | Selects output gain of 0dB when set to logic '1', do not float                                     |
| 14   | Pr_OUT   | Output | Pr, Red, or CV output  |
| 15   | Pb_OUT   | Output | Pb, Blue, or C output  |
| 16   | Y_OUT    | Output | Y, Green, or Y output  |
| 17   | RGB      | Input  | Selects RGB MUX inputs and clamp mode when set to logic '1', do not float                          |
| 18   | SYNC_IN  | Input  | External sync input signal, square wave crossing Vil and Vih input thresholds, do not float        |
| 19   | VCC      | Input  | +5V supply, do not float   |
| 20   | VCC      | Input  | +5V supply, do not float   |

## Gain Settings

| 0dB, Pin 13 | Gain (dB) | V <sub>IN</sub> * | V <sub>OUT</sub> * |
|-------------|-----------|-------------------|--------------------|
| 0           | 6         | 1V <sub>pp</sub>  | 2V <sub>pp</sub>   |
| 1           | 0         | 1V <sub>pp</sub>  | 1V <sub>pp</sub>   |

\* Video level, does not include clamp voltage which will offset the input above ground.

## Sync Settings

| EXT_SYNC, Pin1 | Sync Source          |
|----------------|----------------------|
| 0              | Y/G input, Pin 3/4   |
| 1              | SYNC_IN input, Pin 2 |

## Filter Settings

| F <sub>SEL1</sub> , Pin 10 | F <sub>SEL0</sub> , Pin 9 | Filter -3dB Freq | Video Format    | Sync Format                  |
|----------------------------|---------------------------|------------------|-----------------|------------------------------|
| 0                          | 0                         | 8.2MHz           | SD, 480i        | Bi-level, 4.7μs pulse width  |
| 0                          | 1                         | 15MHz            | PS, 480p        | Bi-level, 2.35μs pulse width |
| 1                          | 0                         | 32MHz            | HD, 1080i, 720p | Tri-level, 589ns pulse width |
| 1                          | 1                         | Filter Bypass    | –               | Bi-level, 2.35μs pulse width |

## I/O and Clamp Settings

| RGB, Pin 17 | CV_SEL, Pin 2     | Input       | Output     | Clamp Voltage |
|-------------|-------------------|-------------|------------|---------------|
| 0           | X<br>(don't care) | Y, Pin 3    | Y, Pin 16  | 250mV         |
|             |                   | Pb, Pin 5   | Pb, Pin 15 | 1.125V        |
|             |                   | Pr, Pin 7   | Pr, Pin 14 | 1.125V        |
| 1           | 0                 | G/Y, Pin 4  | G, Pin 16  | 250mV         |
|             |                   | B/C, Pin 6  | B, Pin 15  | 250mV         |
|             |                   | R/CV, Pin 8 | R, Pin 14  | 250mV         |
| 1           | 1                 | Y/G, Pin 4  | Y, Pin 16  | 250mV         |
|             |                   | C/B, Pin 6  | C, Pin 15  | 1.125V        |
|             |                   | CV/R, Pin 8 | CV, Pin 14 | 250mV         |

## Functional Description

### Introduction

The FMS6407 is a next generation filter solution from Fairchild Semiconductor addressing the expanding filtering needs for televisions, set top boxes, and DVD players including progressive scan capability. The product provides selectable filtering with cutoff frequencies of 30MHz, 15MHz, and 8.0MHz on the YPbPr, RGB and YC-CV channels. In addition, the filters can be bypassed for wider bandwidth applications. The FMS6407 allows consumer devices to support a variety of resolution standards with the same hardware.

Multiplexers on the YPbPr / RGB / YC-CV channels provide further flexibility. When the input multiplexer is changed from YPbPr to RGB mode the sync tip clamp voltages are changed appropriately. All three channels are set for 250mV sync tips to reduce DC-coupled power dissipation for RGB inputs. The lower output bias voltage is not suitable for the PbPr outputs so for YPbPr inputs these signals are clamped to 1.125V while Y is still clamped to 250mV. For systems running YPbPr and YC-CV signals, the Y and CV signals will be clamped to 250mV while C is clamped to 1.125V. Sync tip clamping voltages are set by forcing the desired DC bias level during the active sync period. For systems without sync on green, an external sync input is provided. If sync exists on the Y input signal but not on the G input signal, the RGB and EXT\_SYNC control inputs may be wired together on the PCB to switch the sync source with the input source. Both standard definition (bi-level) and high definition (tri-level) sync are supported at YIN and SYNC\_IN depending on the FSEL[1:0] inputs.

Standard definition (480i) and progressive (480p) signals are clamped by forcing the signal to the desired voltage during the sync pulse. For signals with sync, the sync tip itself will be forced to the clamp voltage (typically 250mV). When high definition sync is present (tri-level sync) the sync tip duration is too short to allow this approach. In order to accurately clamp HD signals, the sync pulse starts a timer and the actual clamping is done at the blanking level right after the sync pulse. The sync tip will still typically be placed at 250mV.

All three outputs are driven by amplifiers with selectable gains of 0dB or +6dB. These amplifiers can drive two terminated video loads (75Ω) to 2V<sub>pp</sub> with a 1V<sub>pp</sub> input when set to 6dB gain. The input range is limited to 1.5V<sub>pp</sub> and the output range is limited to 2.5V<sub>pp</sub>.

All control inputs must be tied to V<sub>SS</sub> or V<sub>CC</sub>. Do not leave them floating.

### External Sync Mode

The FMS6407 can properly recover sync timing from video signals that include sync. If the Y-input video signals does

not include sync, the FMS6407 can be used in External SYNC Mode. When the FMS6407 is used in external sync mode, (EXT\_SYNC pin is high), a pulsed input must be applied to the SYNC\_IN pin. If there is no video signal present, therefore no sync signal present, there must still be an input applied to the SYNC\_IN pin. When there is no video signal on the video inputs SYNC\_IN can be a sync pulse every 60μs to mimic the slowest sync in a regular video signal. The following two sections discuss the sync processing and timing required in more detail.

### SD and Progressive Scan Video Sync Processing

The FMS6407 must control the DC offset of AC-coupled input signals since the average DC level of video varies with image content. If the input offset is allowed to wander, the common mode input range of the amplifiers can be exceeded leading to signal distortion. DC offset adjustment is referred to as clamping or in some cases, biasing, and must be done at the correct time during each video line. The optimum time is during the sync pulse since it is the lowest input voltage. This approach works well for 480i and 480p signals since the sync tip duration is long enough to allow the DC-offset errors to be compensated from line to line. The DC-offset of the sync tip is adjusted as illustrated in Figure 1 by forcing a current on the input during the sync pulse. The sync tip will be clamped to approximately 250mV. Signals like Pb and Pr with a symmetric voltage range (±350mV) will be clamped to approximately 1.125V. Note that the following diagrams indicate output voltage levels for both 0dB and 6dB gain (1V<sub>pp</sub> and 2V<sub>pp</sub> video signals at the FMS6407 output pin).

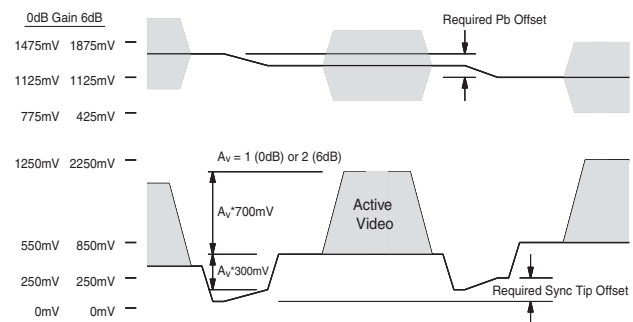
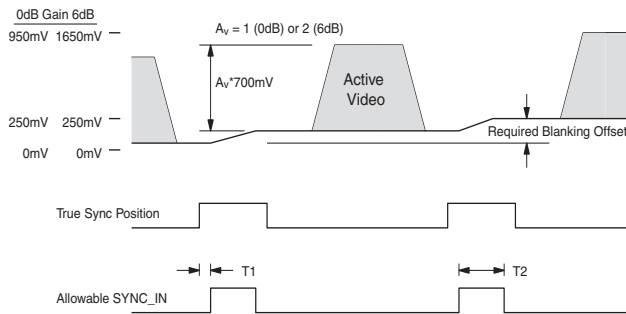

**Figure 1. Bi-Level Sync Tip Clamping and Bias**

In some cases, the sync voltage may be compressed to less than the nominal 300mV value. The FMS6407 can successfully recover SD and Progressive Scan sync which is greater than 100mV (compressed to 33% of nominal).

The FMS6407 can properly recover sync timing from luma and green which include sync. If none of the video signals includes sync, the EXT\_SYNC control input can be set high

and an external sync signal must be input on the SYNC\_IN pin. Refer to the External Sync section for more details. The timing required for this operating mode is shown in Figure 2.



**Figure 2. Bi-Level External Sync Clamping and Bias**

**HD Video Sync Processing**

When the input signal is a high definition signal, the tri-level sync pulse is too short to allow proper clamp operation. Rather than clamp during the sync pulse, the sync pulse is located and the signal is clamped to the blanking level. This is done in such a way that the sync tip will still be set to approximately 250mV. The EXT\_SYNC control input selects the sync stripper output or the SYNC\_IN pin for use by the clamp circuit. This means that the SYNC\_IN timing for HD signals is different than the timing for SD or PS signals. For HD signals, the SYNC\_IN signal must be high when the clamp must be active. This is during the time immediately after the sync pulse while the signal is at the blanking level. This operation is shown in Figure 3. Note that the following diagrams indicate output voltage levels for both 0dB and 6dB gain (1V<sub>pp</sub> and 2V<sub>pp</sub> video signals at the FMS6407 output pin).

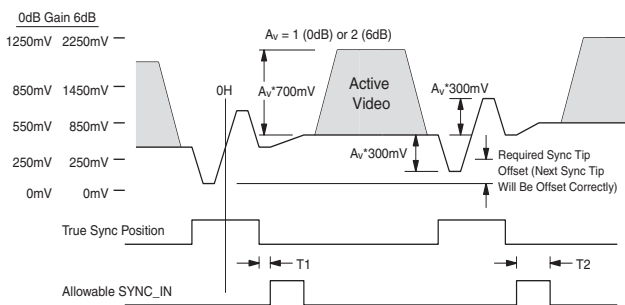
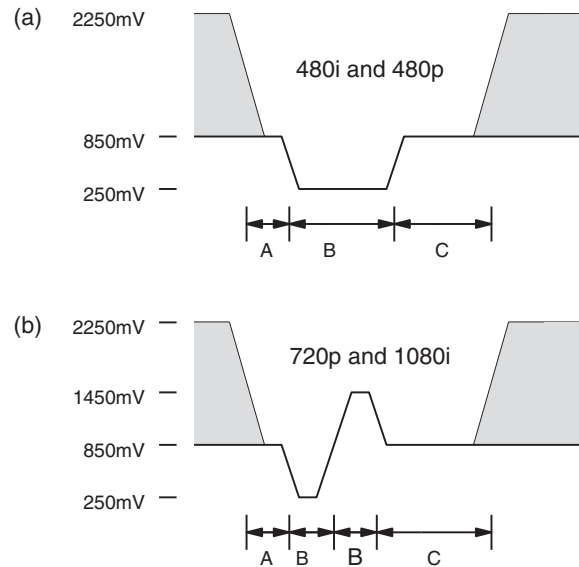

**Figure 3. Tri-Level Blanking Clamp**

**NOTE:** Tri-level sync may only be compressed 5%. If tri-level sync is compressed more than 5% it may not be properly located.

**Sync Timing**

Normally, the FMS6407 will respond to bi-level sync and clamp the sync tip during period ‘B’ in Figure 4(a). When the filters are switched to high definition mode (30MHz) the sync processing will respond to tri-level sync and clamp to the blanking level during period ‘C’ in Figure 4(b).



**Figure 4. Sync Timing; Bi-Level (a), Tri-Level (b)**

The tri-level sync pulse is located such that the broad pulses in the vertical interval do not trigger the clamp. In order to improve the system settling at turn-on, the broad pulses will be clamped to just above ground. Once the broad pulses (and tri-level sync tips) are above ground, the normal clamping process takes over and clamps to the blanking level during period ‘C’ in Figure 4(b).

The FMS6407 is designed to support the video standards and associated sync timings shown in Table I on page 12 (additional standards such as 483p59.94 will also work correctly). The filter settings table from page 9 is repeated on page 12 for convenience.

## Filter Settings

| F <sub>SEL1</sub> , Pin 10 | F <sub>SEL0</sub> , Pin 9 | Filter -3dB Freq | Video Format    | Sync Format                  |
|----------------------------|---------------------------|------------------|-----------------|------------------------------|
| 0                          | 0                         | 8.2MHz           | SD, 480i        | Bi-level, 4.7µs pulse width  |
| 0                          | 1                         | 15MHz            | PS, 480p        | Bi-level, 2.35µs pulse width |
| 1                          | 0                         | 32MHz            | HD, 1080i, 720p | Tri-level, 589ns pulse width |
| 1                          | 1                         | Filter Bypass    | –               | Bi-level, 2.35µs pulse width |

Table I

| Format | Refresh | Sample Rate | Period (T) | A           | B            | C             | H-Rate   |
|--------|---------|-------------|------------|-------------|--------------|---------------|----------|
| 480i   | 30Hz    | 13.5MHz     | 74ns       | 20T = 1.5µs | 64T = 4.7µs  | 61T = 4.5µs   | 15.75kHz |
| 480p   | 60Hz    | 27MHz       | 37ns       | 20T = 750ns | 64T = 2.35µs | 61T = 2.25µs  | 31.5kHz  |
| 720p   | 60Hz    | 74.25MHz    | 13.4ns     | 70T = 938ns | 40T = 536ns  | 220T = 2.95µs | 45kHz    |
| 1080i  | 30Hz    | 74.25MHz    | 13.4ns     | 44T = 589ns | 44T = 589ns  | 148T = 1.98µs | 33.75kHz |

Note: Timing values are approximate for 30Hz/60Hz refresh rates.

## Application Information

### Input Circuitry

The DC restore circuit in the FMS6407 requires a source impedance ( $R_{source} = R_s \parallel R_T$ ) of less than or equal to 150Ω for correct operation. Driving the FMS6407 with a high-impedance source (e.g. a DAC loaded with 330Ω) will not yield optimum results.

### Output Drive

The FMS6407 is specified to operate with output currents typically less than 60mA, more than sufficient for a dual (75Ω) video load. Internal amplifiers are current limited to approximately 100mA and should withstand brief duration short circuit conditions, however this capability is not guaranteed.

The maximum specified input voltage of 1.5V<sub>pp</sub> can be sustained for all inputs. When the input is clamped to 1.125V, this does not result in a meaningful output signal. With a gain of 6dB, the output should be 1.125V ±1.5V which is not possible since the output cannot drive below ground. This condition will not damage the part; however, the output will be clipped. For signals which are clamped to 250mV, this does not occur.

Signals that are at midscale during SYNC (Pb, Pr, C) must be clamped to 1.125V and signals that are at their lowest during SYNC (Y, CV, R, G, B) must be clamped to 250mV

for proper operation. Clamping a CV signal to 1.125V will result in clipping the top of the signal and clamping a Pr signal to 250mV will result in clipping the bottom of the signal.

The 220µF capacitor coupled with the 150Ω termination, as shown in the Typical Application Circuit of Figure 5, forms a high pass filter that blocks the DC while passing the video frequencies and avoiding tilt. Any value lower than 220µF will create problems, such as video tilt. Higher values, such as 470µF - 1000µF are the most optimal output coupling capacitor. By AC coupling, the average DC level is zero. Thus, the output voltages of all channels will be centered around zero.

### Sync Recovery

The FMS6407 will typically recover bi-level sync with amplitude greater than 100mV (33% compressed relative to the nominal 300mV amplitude). The FMS6407 looks for the lowest signal voltage and clamps this to approximately 250mV at the output.

Tri-level sync may not be compressed more than 5% (15mV) for correct operation. Tri-level sync is located by finding the edges of the tri-level pulse and running a timer to operate the clamp during the back porch interval.

Since only the Y/G channel is processed for sync recovery, Y and CV inputs must be synchronous.

## Power Dissipation

The FMS6407 output drive configuration must be considered when calculating overall power dissipation. Care must be taken not to exceed the maximum die junction temperature. The following example can be used to calculate the FMS6407's power dissipation and internal temperature rise.

$$T_j = T_A + P_d \cdot \Theta_{JA}$$

$$\text{where } P_d = P_{CH1} + P_{CH2} + P_{CH3}$$

$$\text{and } P_{CHx} = V_s \cdot I_{CH} - (V_O^2/R_L)$$

where

$$V_O = 2V_{in} + 0.280V$$

$$I_{CH} = (I_{CC} / 3) + (V_O/R_L)$$

$V_{in}$  = RMS value of input signal

$$I_{CC} = 105\text{mA}$$

$$V_s = 5V$$

$R_L$  = channel load resistance

Board layout can also affect thermal characteristics. Refer to the *Layout Considerations* Section for more information. The FMS6407 is specified to operate with output currents typically less than 60mA, more than sufficient for a single (150Ω) video load. Internal amplifiers are current limited to a maximum of 100mA and should withstand brief duration short circuit conditions, however this capability is not guaranteed.

## Layout Considerations

General layout and supply bypassing play major roles in high frequency performance and thermal characteristics. Fairchild offers a demonstration board, FMS6407DEMO, to use as a guide for layout and to aid in device testing and characterization. The FMS6407DEMO is a 4-layer board with a full power and ground plane. For optimum results, follow the steps below as a basis for high frequency layout:

- Include 10μF and 0.1μF ceramic bypass capacitors
- Place the 10μF capacitor within 0.75 inches of the power pin
- Place the 0.1μF capacitor within 0.1 inches of the power pin
- Connect all external ground pins as tightly as possible, preferably with a large ground plane under the package
- Layout channel connections to reduce mutual trace inductance
- Minimize all trace lengths to reduce series inductances. If routing across a board, place device such that longer traces are at the inputs rather than the outputs.

If using multiple, low impedance DC coupled outputs, special layout techniques may be employed to help dissipate heat.

For dual-layer boards, place a 0.5" to 1" (1.27cm to 2.54cm) square ground plane directly under the device and on the bottom side of the board. Use multiple vias to connect the ground planes. For multi-layer boards, additional planes (connected with vias) can be used for additional thermal improvements.

Worse case additional die power due to DC loading can be estimated at  $(V_{CC}^2/4R_{load})$  per output channel. This assumes a constant DC output voltage of  $V_{CC}^2$ . For 5V  $V_{CC}$  with a dual DC video load, add  $25/(4*75) = 83\text{mW}$ , per channel.

A package option with an exposed DAP is available for improved thermal performance, see *Ordering Information* on page 16. For layout recommendations using the ePAD package, refer to the following: [http://www.amkor.com/products/notes\\_papers/epad.pdf](http://www.amkor.com/products/notes_papers/epad.pdf)

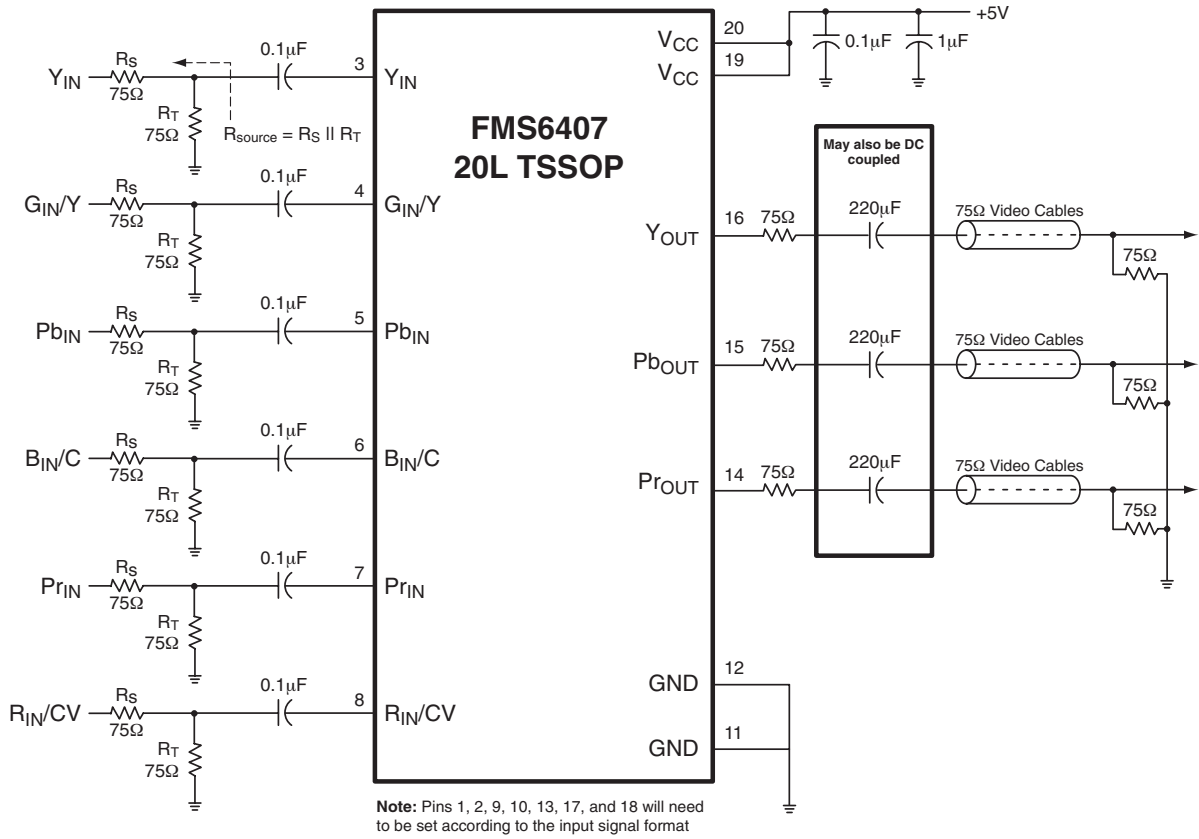
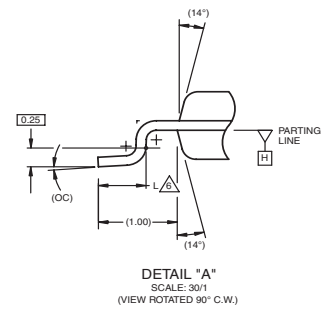
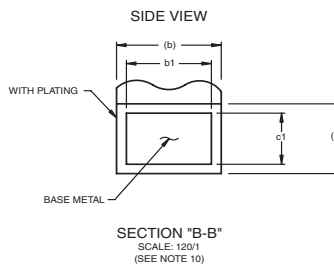
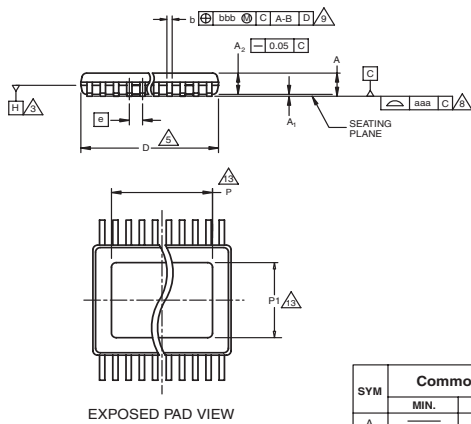
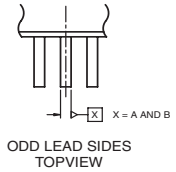
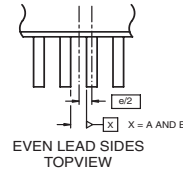
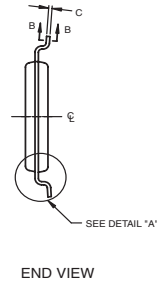
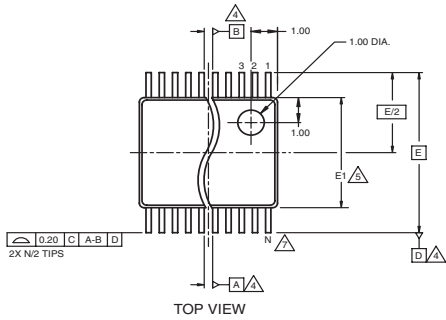

Figure 5. Typical Application Circuit

# Package Dimensions

## TSSOP-20 and ePAD TSSOP-20



| SYM | Common Dimensions |       |      | Note |
|-----|-------------------|-------|------|------|
|     | MIN.              | NOM.  | MAX. |      |
| A   |                   |       | 1.10 |      |
| A1  | 0.05              |       | 0.15 |      |
| A2  | 0.85              | 0.90  | 0.95 |      |
| aaa |                   | 0.076 |      |      |
| b   | 0.19              |       | 0.30 | 9    |
| b1  | 0.19              | 0.22  | 0.25 |      |
| bbb |                   | 0.10  |      |      |
| c   | 0.09              |       | 0.20 |      |
| c1  | 0.09              | 0.127 | 0.16 |      |
| D   | 6.40              | 6.50  | 6.60 | 5    |
| E1  | 4.30              | 4.40  | 4.50 | 5    |
| e   | 0.65 BSC          |       |      |      |
| E   | 6.40 BSC          |       |      |      |
| L   | 0.50              | 0.60  | 0.70 | 6    |
| N   | 20                |       |      | 7    |
| P   | 4.2               |       |      | 13   |
| P1  | 3.0               |       |      | 13   |
| CC  | 0°                |       |      | 8°   |

Note: For 0.65mm pitch.  
All dimensions in millimeters.

### NOTES:

- DIE THICKNESS ALLOWABLE IS 0.279±0.0127 (.0110±.0005 INCHES)
- DIMENSIONING & TOLERANCES PER ASME. Y14.5M-1994.
- DATUM PLANE H LOCATED AT MOLD PARTING LINE AND COINCIDENT WITH LEAD, WHERE LEAD EXITS PLASTIC BODY AT BOTTOM OF PARTING LINE.
- DATUM A-B AND D TO BE DETERMINED WHERE CENTERLINE BETWEEN LEADS EXITS PLASTIC BODY AT DATUM PLANE H.
- "D" & "E1" ARE REFERENCE DATUM AND DO NOT INCLUDE MOLD FLASH OR PROTRUSIONS, AND ARE MEASURED AT THE BOTTOM PARTING LINE. MOLD FLASH OR PROTRUSIONS SHALL NOT EXCEED 0.15mm ON D AND 0.25mm ON E PER SIDE.
- DIMENSION IS THE LENGTH OF TERMINAL FOR SOLDERING TO A SUBSTRATE.
- TERMINAL POSITIONS ARE SHOWN FOR REFERENCE ONLY.
- FORMED LEADS SHALL BE PLANAR WITH RESPECT TO ONE ANOTHER WITHIN 0.076mm AT SEATING PLANE.
- THE LEAD WIDTH DIMENSION DOES NOT INCLUDE DAMBAR PROTRUSION. ALLOWABLE DAMBAR PROTRUSION SHALL BE 0.07mm TOTAL IN EXCESS OF THE LEAD WIDTH DIMENSION AT MAXIMUM MATERIAL CONDITION. DAMBAR CANNOT BE LOCATED ON THE LOWER RADIUS OR THE FOOT. MINIMUM SPACE BETWEEN PROTRUSIONS AND AN ADJACENT LEAD SHOULD BE 0.07mm FOR 0.65MM PITCH, 0.08MM FOR 0.50MM PITCH AND 0.07mm FOR 0.40MM PITCH PACKAGES. SEE SECTION "B-B".
- SECTION "B-B" TO BE DETERMINED AT 0.10 TO 0.25 MM FROM THE LEAD TIP.
- CONTROLLING DIMENSION: MILLIMETERS.
- THIS PART IS COMPLIANT WITH JEDEC SPECIFICATION MO-153 VARIATIONS AA/AAT, AB-1/ABT-1, AB/ABT, AC/ACT, AD/ADT, AE/AET BC-1/BCT-1, BD-1/BDT-1, BE/BET, CA/CAT & CD/CDT AND MO-194 VARIATIONS AC/ACT & AF/AFT.
- DIMENSIONS "P" AND "P1" ARE THERMALLY ENHANCED VARIATIONS. VALUES SHOWN ARE MAXIMUM SIZE OF EXPOSED PAD WITHIN LEAD COUNT AND BODY SIZE. END USER SHOULD VERIFY AVAILABLE SIZE OF EXPOSED PAD FOR SPECIFIC DEVICE APPLICATION.

## Ordering Information

| Model   | Part Number   | Lead Free | Package       | Container     | Pack Qty |
|---------|---------------|-----------|---------------|---------------|----------|
| FMS6407 | FMS6407MTC20  | Yes       | TSSOP-20      | Tube          | 94       |
| FMS6407 | FMS6407MTC20X | Yes       | TSSOP-20      | Tape and Reel | 2500     |
| FMS6407 | FMS6407MTF20  | Yes       | ePAD TSSOP-20 | Tube          | 94       |
| FMS6407 | FMS6407MTF20X | Yes       | ePAD TSSOP-20 | Tape and Reel | 2500     |

Temperature range for all parts: 0°C to +70°C.

**TRADEMARKS**

The following are registered and unregistered trademarks Fairchild Semiconductor owns or is authorized to use and is not intended to be an exhaustive list of all such trademarks.

|                                      |                     |               |                     |                 |
|--------------------------------------|---------------------|---------------|---------------------|-----------------|
| ACEx™                                | FAST®               | IntelliMAX™   | POP™                | SPM™            |
| ActiveArray™                         | FASTr™              | ISOPLANAR™    | Power247™           | Stealth™        |
| Bottomless™                          | FPS™                | LittleFET™    | PowerEdge™          | SuperFET™       |
| CoolFET™                             | FRFET™              | MICROCOUPLER™ | PowerSaver™         | SuperSOT™-3     |
| CROSSVOLT™                           | GlobalOptoisolator™ | MicroFET™     | PowerTrench®        | SuperSOT™-6     |
| DOME™                                | GTO™                | MicroPak™     | QFET®               | SuperSOT™-8     |
| EcoSPARK™                            | HiSeC™              | MICROWIRE™    | QS™                 | SyncFET™        |
| E <sup>2</sup> CMOS™                 | ꞑC™                 | MSX™          | QT Optoelectronics™ | TinyLogic®      |
| EnSigna™                             | <i>i-Lo</i> ™       | MSXPro™       | Quiet Series™       | TINYOPTO™       |
| FACT™                                | ImpliedDisconnect™  | OCX™          | RapidConfigure™     | TruTranslation™ |
| FACT Quiet Series™                   |                     | OCXPro™       | RapidConnect™       | UHC™            |
| Across the board. Around the world.™ |                     | OPTOLOGIC®    | µSerDes™            | UltraFET®       |
| The Power Franchise®                 |                     | OPTOPLANAR™   | SILENT SWITCHER®    | UniFET™         |
| Programmable Active Droop™           |                     | PACMAN™       | SMART START™        | VCX™            |

**DISCLAIMER**

FAIRCHILD SEMICONDUCTOR RESERVES THE RIGHT TO MAKE CHANGES WITHOUT FURTHER NOTICE TO ANY PRODUCTS HEREIN TO IMPROVE RELIABILITY, FUNCTION OR DESIGN. FAIRCHILD DOES NOT ASSUME ANY LIABILITY ARISING OUT OF THE APPLICATION OR USE OF ANY PRODUCT OR CIRCUIT DESCRIBED HEREIN; NEITHER DOES IT CONVEY ANY LICENSE UNDER ITS PATENT RIGHTS, NOR THE RIGHTS OF OTHERS.

**LIFE SUPPORT POLICY**

FAIRCHILD'S PRODUCTS ARE NOT AUTHORIZED FOR USE AS CRITICAL COMPONENTS IN LIFE SUPPORT DEVICES OR SYSTEMS WITHOUT THE EXPRESS WRITTEN APPROVAL OF FAIRCHILD SEMICONDUCTOR CORPORATION. As used herein:

1. Life support devices or systems are devices or systems which, (a) are intended for surgical implant into the body, or (b) support or sustain life, or (c) whose failure to perform when properly used in accordance with instructions for use provided in the labeling, can be reasonably expected to result in significant injury to the user.
2. A critical component is any component of a life support device or system whose failure to perform can be reasonably expected to cause the failure of the life support device or system, or to affect its safety or effectiveness.



**PRODUCT STATUS DEFINITIONS****Definition of Terms**

| Datasheet Identification | Product Status         | Definition  |
|--------------------------|------------------------|---|
| Advance Information      | Formative or In Design | This datasheet contains the design specifications for product development. Specifications may change in any manner without notice.  |
| Preliminary              | First Production       | This datasheet contains preliminary data, and supplementary data will be published at a later date. Fairchild Semiconductor reserves the right to make changes at any time without notice in order to improve design. |
| No Identification Needed | Full Production        | This datasheet contains final specifications. Fairchild Semiconductor reserves the right to make changes at any time without notice in order to improve design.   |
| Obsolete                 | Not In Production      | This datasheet contains specifications on a product that has been discontinued by Fairchild semiconductor. The datasheet is printed for reference information only.   |

Rev. I15

## Looking for pricing, stock, or lifecycle information?

Click below to explore more details on WIN SOURCE:

-  [View FMS6407MTF20X on WIN SOURCE](#)
-  [ON Semiconductor](#) Information

## Optimize Your Supply Chain with WIN SOURCE Solutions

-  Global Sourcing Solution
-  Obsolete Management
-  Cost Control Management
-  Shortage Management
-  Alternative Solution
-  Excess Inventory Management