



THE DATASHEET OF FMPA2151



FMPA2151

2.4–2.5 GHz and 4.9–5.9 GHz Dual Band Linear Power Amplifier Module (Preliminary)

Features

- Dual band operation in a single package design
- Integrated bias bypass
- >30 dB modulated gain 2.4 to 2.5 GHz band
- >30 dB modulated gain 4.9 to 5.9 GHz band
- 27 dBm output power @ 1 dB compression for both frequency bands
- 3.5 % EVM at 20 dBm modulated power out (2.4 GHz)
- 3.5 % EVM at 20 dBm modulated power out (5.5 GHz)
- 3.3 V positive supply operation
- Separate integrated power detectors with 20 dB dynamic range
- 16 pin 4 x 4 x 1.4 mm leadless package
- Internally matched to 50 ohms and DC blocked RF input/output
- Optimized for use in 802.11a/b/g applications

General Description

The FMPA2151 is a dual frequency band power amplifier module designed for high performance WLAN applications in the 2.4-2.5 GHz and the 4.90-5.9 GHz frequency bands. The 16 pin 4 x 4 x 1.4 mm package with internal matching on both input and output to 50 Ohms minimizes next level PCB space and allows for simplified integration. Only two external bias bypass capacitors are required. The two on-chip detectors provide power sensing capability. The PA's low power consumption and excellent linearity are achieved using our InGaP Heterojunction Bipolar Transistor (HBT) technology.

Device (4 x 4 x 1.4mm)

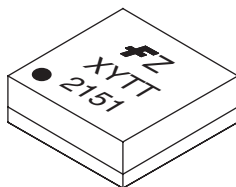

Electrical Characteristics¹ 802.11g (2.4-2.5 GHz) OFDM Modulation (with 176 μ s burst time, 100 μ s idle time) 54 Mbps Data Rate, 16.7 MHz Bandwidth

Parameter	Min	Typ	Max	Units
Frequency	2.4		2.5	GHz
Collector Supply Voltage	3.0	3.3	3.6	V
Mirror Supply Voltage (PA ON 2.4)	2.6	3.0	3.6	V
Mirror Supply Current (PA ON 2.4)		0.1		mA
Gain		31		dB
Average Packet Current @ +20dBm Pout		170		mA
EVM @ +20dBm Pout ²		3.5		%
Detector Output @ +20dBm Pout		850		mV
Detector Output @ +5dBm Pout		230		mV
POUT Spectral Mask Compliance ³		+20		dBm

Notes:

1. VCC=3.3V, PA ON 2.4=3.3V, T_A=25°C, PA is constantly biased, 50% system.
2. Percentage includes system noise floor of EVM=0.8%.
3. Measured at PIN at which Spectral Mask Compliance is satisfied. Two-sample windowing length applied.

Electrical Characteristics¹ 802.11a OFDM Modulation

(with 176 μ s burst time, 100 μ s idle time) 54 Mbps Data Rate, 16.7 MHz Bandwidth

Parameter	Min	Typ	Max	Units
Frequency	4.9		5.9	GHz
Collector Supply Voltage	3.0	3.3	3.6	V
Mirror Supply Voltage (PA ON 5.5)	2.6	3.0	3.6	V
Mirror Supply Current (PA ON 5.5)		0.1		mA
Gain		32		dB
Average Packet Current @ +20dBm Pout		295		mA
EVM @ +18dBm Pout ² (4.9 to 5.35GHz)		3.5		%
EVM @ +20dBm Pout ² (5.35 to 5.9GHz)		3.5		%
Detector Output @ +20dBm Pout		820		mV
Detector Output @ +5dBm Pout		195		mV
POUT Spectral Mask Compliance ³		+20		dBm

Absolute Maximum Ratings⁴

Symbol	Parameter	Ratings	Units
VCC	Positive Supply Voltage	6	V
ICC	Supply Current	500	mA
PA ON	Positive Bias Voltage	4	V
Pin	RF Input Power	0	dBm
Tcase	Case Operating Temperature	-40 to +85	°C
Tstg	Storage Temperature	-55 to +150	°C

Notes:

1. VCC=3.3V, PA ON 5.5=3.3V, T_A=25°C, PA is constantly biased, 50% system.
2. Percentage includes system noise floor of EVM=0.8%.
3. Measured at PIN at which Spectral Mask Compliance is satisfied. Two-sample windowing length applied.
4. No permanent damage with one parameter set at extreme limit. Other parameters set to typical values.

Performance Data 802.11b/g OFDM Modulation

(with 176 ms burst time, 100 ms idle time) 54 Mbps Data Rate, 16.7 MHz Bandwidth

FFPA2151 EVM vs Modulated Output Power 802.11b/g Band

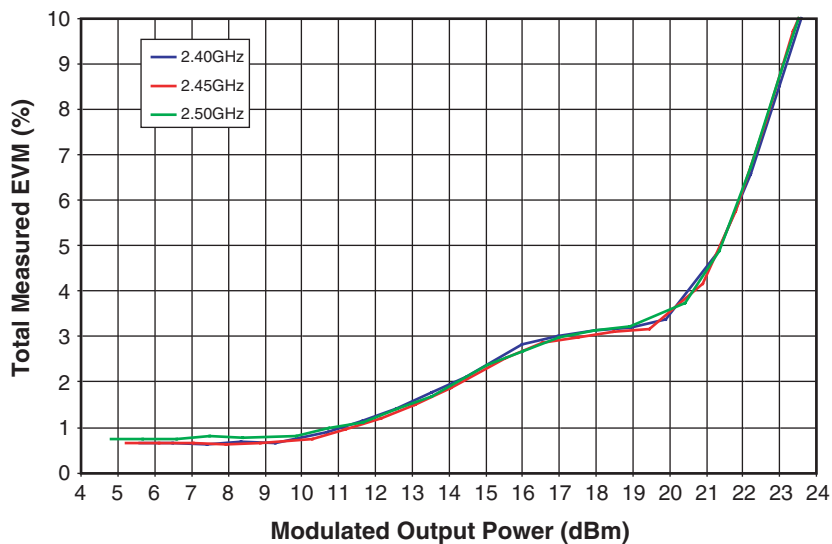

Note: Uncorrected EVM. Source EVM is approximately 0.8%.

Single Tone

FFPA2151 S-Parameters 802.11b/g Band

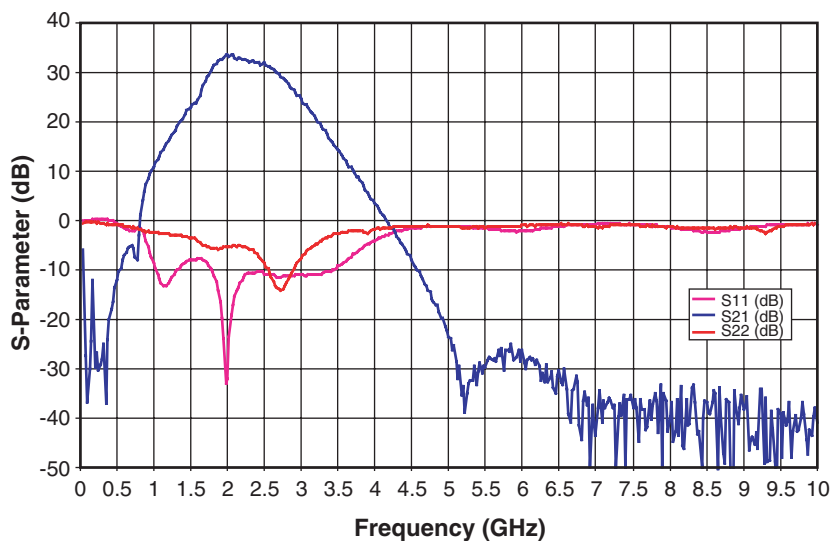

Performance Data 802.11a OFDM Modulation

(with 176 ms burst time, 100 ms idle time) 54 Mbps Data Rate, 16.7 MHz Bandwidth

FFPA2151 EVM vs Modulated Output Power 802.11a Band

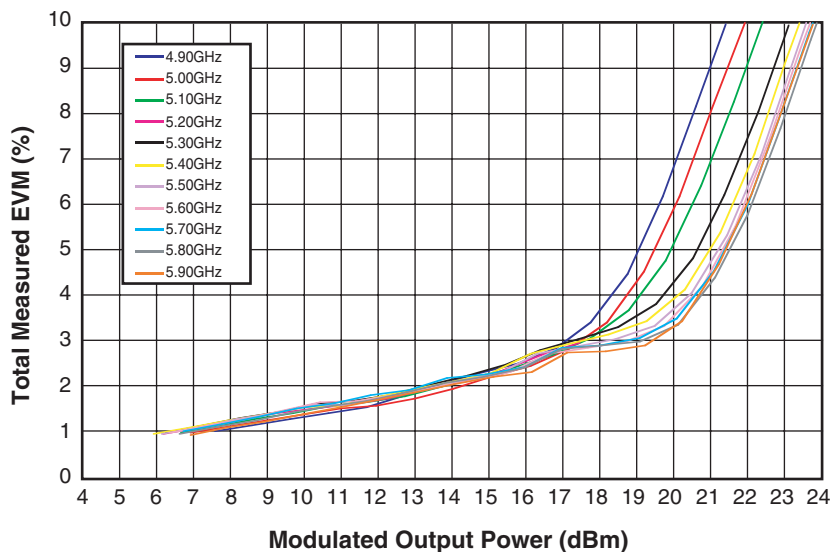

Note: Uncorrected EVM. Source EVM is approximately 0.8%.

Single Tone

FFPA2151 S-Parameters 802.11a Band

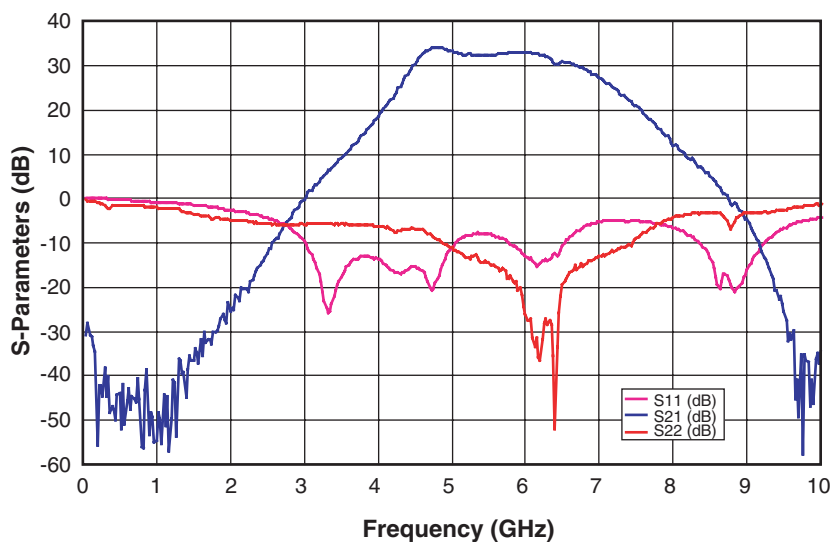

Schematic

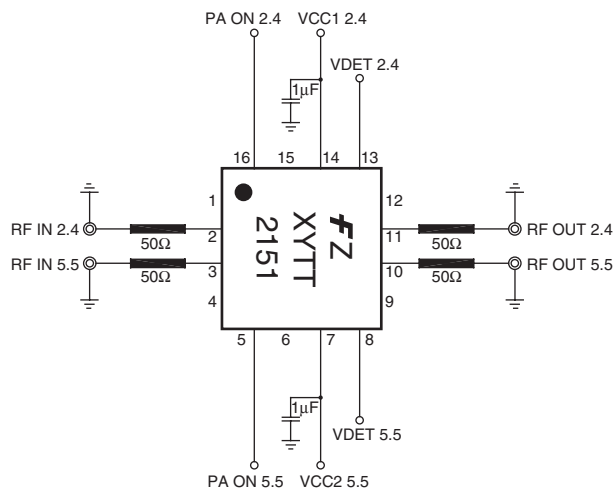

Pin	Description
1	GND
2	RF IN 2.4
3	RF IN 5.5
4	GND
5	PA ON 5.5
6	GND
7	VCC2 5.5
8	VDET 5.5
9	GND
10	RF OUT 5.5
11	RF OUT 2.4
12	GND
13	VDET 2.4
14	VCC1 2.4
15	GND
16	PA ON 2.4
17	CENTER GND

Package Outline

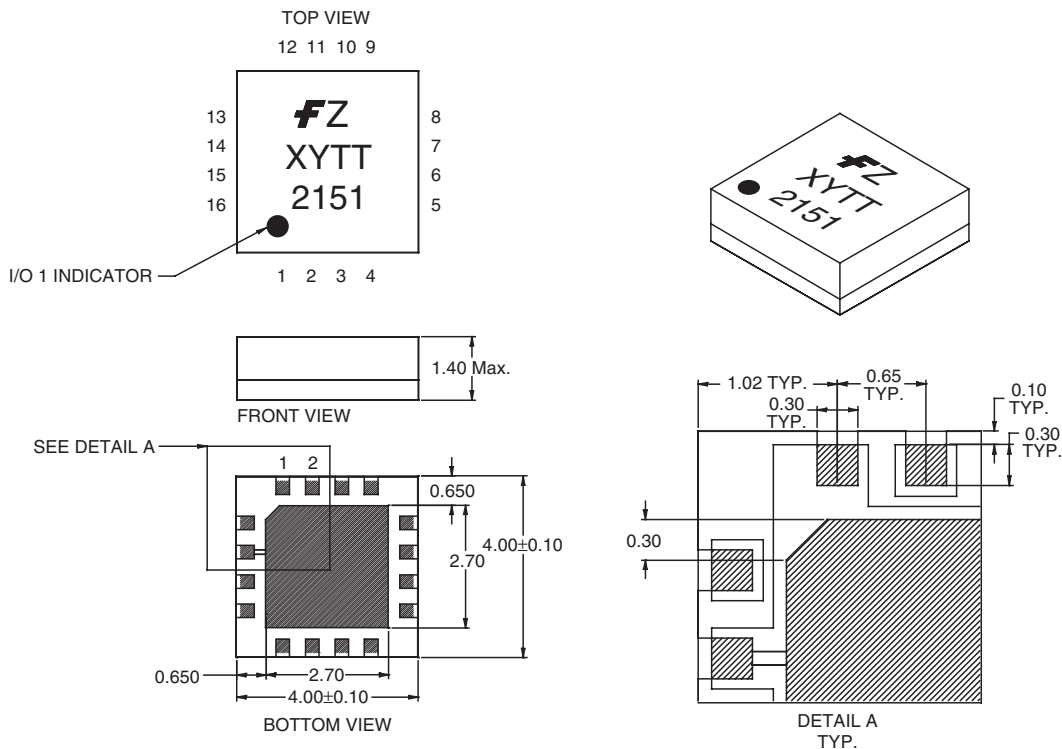

TRADEMARKS

The following are registered and unregistered trademarks Fairchild Semiconductor owns or is authorized to use and is not intended to be an exhaustive list of all such trademarks.

ACEx™	FAST®	IntelliMAX™	POP™	SPM™
ActiveArray™	FASTr™	ISOPLANAR™	Power247™	Stealth™
Bottomless™	FPST™	LittleFET™	PowerEdge™	SuperFET™
CoolFET™	FRFET™	MICROCOUPLER™	PowerSaver™	SuperSOT™-3
CROSSVOLT™	GlobalOptoisolator™	MicroFET™	PowerTrench®	SuperSOT™-6
DOMET™	GTO™	MicroPak™	QFET®	SuperSOT™-8
EcoSPARK™	HiSeC™	MICROWIRE™	QS™	SyncFET™
E ² CMOS™	ꝑC™	MSX™	QT Optoelectronics™	TinyLogic®
EnSigna™	i-Lo™	MSXPro™	Quiet Series™	TINYOPTO™
FACT™	ImpliedDisconnect™	OCX™	RapidConfigure™	TruTranslation™
FACT Quiet Series™		OCXPro™	RapidConnect™	UHC™
Across the board. Around the world.™		OPTOLOGIC®	µSerDes™	UltraFET®
The Power Franchise®		OPTOPLANAR™	SILENT SWITCHER®	UniFET™
Programmable Active Droop™		PACMAN™	SMART START™	VCX™

DISCLAIMER

FAIRCHILD SEMICONDUCTOR RESERVES THE RIGHT TO MAKE CHANGES WITHOUT FURTHER NOTICE TO ANY PRODUCTS HEREIN TO IMPROVE RELIABILITY, FUNCTION OR DESIGN. FAIRCHILD DOES NOT ASSUME ANY LIABILITY ARISING OUT OF THE APPLICATION OR USE OF ANY PRODUCT OR CIRCUIT DESCRIBED HEREIN; NEITHER DOES IT CONVEY ANY LICENSE UNDER ITS PATENT RIGHTS, NOR THE RIGHTS OF OTHERS.

LIFE SUPPORT POLICY

FAIRCHILD'S PRODUCTS ARE NOT AUTHORIZED FOR USE AS CRITICAL COMPONENTS IN LIFE SUPPORT DEVICES OR SYSTEMS WITHOUT THE EXPRESS WRITTEN APPROVAL OF FAIRCHILD SEMICONDUCTOR CORPORATION. As used herein:

1. Life support devices or systems are devices or systems which, (a) are intended for surgical implant into the body, or (b) support or sustain life, or (c) whose failure to perform when properly used in accordance with instructions for use provided in the labeling, can be reasonably expected to result in significant injury to the user.
2. A critical component is any component of a life support device or system whose failure to perform can be reasonably expected to cause the failure of the life support device or system, or to affect its safety or effectiveness.

PRODUCT STATUS DEFINITIONS

Definition of Terms

Datasheet Identification	Product Status	Definition
Advance Information	Formative or In Design	This datasheet contains the design specifications for product development. Specifications may change in any manner without notice.
Preliminary	First Production	This datasheet contains preliminary data, and supplementary data will be published at a later date. Fairchild Semiconductor reserves the right to make changes at any time without notice in order to improve design.
No Identification Needed	Full Production	This datasheet contains final specifications. Fairchild Semiconductor reserves the right to make changes at any time without notice in order to improve design.
Obsolete	Not In Production	This datasheet contains specifications on a product that has been discontinued by Fairchild semiconductor. The datasheet is printed for reference information only.

Looking for pricing, stock, or lifecycle information?

Click below to explore more details on WIN SOURCE:

- ⊖ [View FMPA2151 on WIN SOURCE](#)
- ⊖ [Fairchild/ON Semiconductor Information](#)

Optimize Your Supply Chain with WIN SOURCE Solutions

- ✓ Global Sourcing Solution
- ✓ Obsolete Management
- ✓ Cost Control Management
- ✓ Shortage Management
- ✓ Alternative Solution
- ✓ Excess Inventory Management