



# THE DATASHEET OF FGH60N60SMD



# IGBT - Field Stop

## 600 V, 60 A

### FGH60N60SMD

#### Description

Using novel field stop IGBT technology, ON Semiconductor's new series of field stop 2<sup>nd</sup> generation IGBTs offer the optimum performance for solar inverter, UPS, welder, telecom, ESS and PFC applications where low conduction and switching losses are essential.

#### Features

- Maximum Junction Temperature:  $T_J = 175^\circ\text{C}$
- Positive Temperature Co-efficient for easy Parallel Operating
- High Current Capability
- Low Saturation Voltage:  $V_{CE(sat)} = 1.9\text{ V (Typ.) @ } I_C = 60\text{ A}$
- High Input Impedance
- Fast Switching:  $E_{OFF} = 7.5\text{ uJ/A}$
- Tightened Parameter Distribution
- This Device is Pb-Free and is RoHS Compliant

#### Applications

- Solar Inverter, UPS, Welder, PFC, Telecom, ESS



**ON Semiconductor®**

[www.onsemi.com](http://www.onsemi.com)

|           |       |
|-----------|-------|
| $V_{CES}$ | $I_C$ |
| 600 V     | 60 A  |

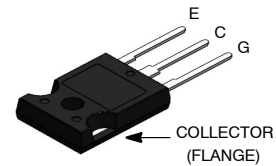
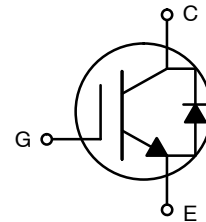

TO-247-3LD  
CASE 340CK

#### MARKING DIAGRAM

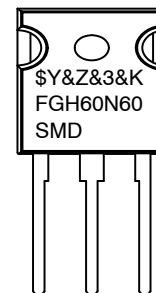

|             |                         |
|-------------|-------------------------|
| \$Y         | = ON Semiconductor Logo |
| &Z          | = Assembly Plant Code   |
| &3          | = Numeric Date Code     |
| &K          | = Lot Code              |
| FGH60N60SMD | = Specific Device Code  |

#### ORDERING INFORMATION

See detailed ordering and shipping information on page 2 of this data sheet.

# FGH60N60SMD

## ABSOLUTE MAXIMUM RATINGS

| Symbol            | Description   | Ratings                   | Unit             |
|-------------------|---|---------------------------|------------------|
| $V_{CES}$         | Collector to Emitter Voltage  | 600                       | V                |
| $V_{GES}$         | Gate to Emitter Voltage   | $\pm 20$                  | V                |
|                   | Transient Gate to Emitter Voltage                                       | $\pm 30$                  | V                |
| $I_C$             | Collector Current   | $T_C = 25^\circ\text{C}$  | 120              |
|                   |   | $T_C = 100^\circ\text{C}$ | 60               |
| $I_{CM}$ (Note 1) | Pulsed Collector Current  | 180                       | A                |
| $I_F$             | Diode Forward Current   | $T_C = 25^\circ\text{C}$  | 60               |
|                   |   | $T_C = 100^\circ\text{C}$ | 30               |
| $I_{FM}$ (Note 1) | Pulsed Diode Maximum Forward Current                                    | 180                       | A                |
| $P_D$             | Maximum Power Dissipation   | $T_C = 25^\circ\text{C}$  | 600              |
|                   |   | $T_C = 100^\circ\text{C}$ | 300              |
| $T_J$             | Operating Junction Temperature  | -55 to +175               | $^\circ\text{C}$ |
| $T_{STG}$         | Storage Temperature Range   | -55 to +175               | $^\circ\text{C}$ |
| $T_L$             | Maximum Lead Temp. for Soldering Purposes, 1/8" from Case for 5 Seconds | 300                       | $^\circ\text{C}$ |

Stresses exceeding those listed in the Maximum Ratings table may damage the device. If any of these limits are exceeded, device functionality should not be assumed, damage may occur and reliability may be affected.

1. Repetitive rating; Pulse width limited by max. junction temperature.

## THERMAL CHARACTERISTICS

| Symbol                  | Parameter                               | Typ. | Max. | Unit                      |
|-------------------------|---|------|------|---------------------------|
| $R_{\theta JC}$ (IGBT)  | Thermal Resistance, Junction to Case    | -    | 0.25 | $^\circ\text{C}/\text{W}$ |
| $R_{\theta JC}$ (Diode) | Thermal Resistance, Junction to Case    | -    | 1.1  | $^\circ\text{C}/\text{W}$ |
| $R_{\theta JA}$         | Thermal Resistance, Junction to Ambient | -    | 40   | $^\circ\text{C}/\text{W}$ |

## PACKAGE MARKING AND ORDERING INFORMATION

| Part Number | Top Mark    | Package | Packing Method | Reel Size | Tape Width | Qty per Tube |
|-------------|-------------|---------|----------------|-----------|------------|--------------|
| FGH60N60SMD | FGH60N60SMD | TO-247  | Tube           | N/A       | N/A        | 30           |

# FGH60N60SMD

## ELECTRICAL CHARACTERISTICS OF THE IGBT ( $T_C = 25^\circ\text{C}$ unless otherwise noted)

| Symbol | Parameter | Test Conditions | Min. | Typ. | Max. | Unit |
|--------|-----------|-----------------|------|------|------|------|
|--------|-----------|-----------------|------|------|------|------|

### OFF CHARACTERISTICS

|                                |  |   |     |     |           |                     |
|--------------------------------|--|---|-----|-----|-----------|---------------------|
| $BV_{CES}$                     | Collector to Emitter Breakdown Voltage       | $V_{GE} = 0\text{ V}, I_C = 250\ \mu\text{A}$ | 600 | –   | –         | V                   |
| $\Delta BV_{CES} / \Delta T_J$ | Temperature Coefficient of Breakdown Voltage | $V_{GE} = 0\text{ V}, I_C = 250\ \mu\text{A}$ | –   | 0.6 | –         | V/ $^\circ\text{C}$ |
| $I_{CES}$                      | Collector Cut-Off Current                    | $V_{CE} = V_{CES}, V_{GE} = 0\text{ V}$       | –   | –   | 250       | $\mu\text{A}$       |
| $I_{GES}$                      | G-E Leakage Current                          | $V_{GE} = V_{GES}, V_{CE} = 0\text{ V}$       | –   | –   | $\pm 400$ | nA                  |

### ON CHARACTERISTICS

|               |   |   |     |     |     |   |
|---------------|---|---|-----|-----|-----|---|
| $V_{GE(th)}$  | G-E Threshold Voltage                   | $I_C = 250\ \mu\text{A}, V_{CE} = V_{GE}$                               | 3.5 | 4.5 | 6.0 | V |
| $V_{CE(sat)}$ | Collector to Emitter Saturation Voltage | $I_C = 60\text{ A}, V_{GE} = 15\text{ V},$                              | –   | 1.9 | 2.5 | V |
|               |   | $I_C = 60\text{ A}, V_{GE} = 15\text{ V},$<br>$T_C = 175^\circ\text{C}$ | –   | 2.1 | –   | V |

### DYNAMIC CHARACTERISTICS

|           |                              |  |   |      |   |    |
|-----------|------------------------------|--|---|------|---|----|
| $C_{ies}$ | Input Capacitance            | $V_{CE} = 30\text{ V}, V_{GE} = 0\text{ V},$<br>$f = 1\text{ MHz}$ | – | 2915 | – | pF |
| $C_{oes}$ | Output Capacitance           |  | – | 270  | – | pF |
| $C_{res}$ | Reverse Transfer Capacitance |  | – | 85   | – | pF |

### SWITCHING CHARACTERISTICS

|              |                          |  |   |      |      |    |
|--------------|--------------------------|--|---|------|------|----|
| $T_{d(on)}$  | Turn-On Delay Time       | $V_{CC} = 400\text{ V}, I_C = 60\text{ A},$<br>$R_G = 3\ \Omega, V_{GE} = 15\text{ V},$<br>Inductive Load, $T_C = 25^\circ\text{C}$  | – | 18   | 27   | ns |
| $T_r$        | Rise Time                |  | – | 47   | 70   | ns |
| $T_{d(off)}$ | Turn-Off Delay Time      |  | – | 104  | 146  | ns |
| $T_f$        | Fall Time                |  | – | 50   | 68   | ns |
| $E_{on}$     | Turn-On Switching Loss   |  | – | 1.26 | 1.94 | mJ |
| $E_{off}$    | Turn-Off Switching Loss  |  | – | 0.45 | 0.6  | mJ |
| $E_{ts}$     | Total Switching Loss     |  | – | 1.71 | 2.54 | mJ |
| $T_{d(on)}$  | Turn-On Delay Time       | $V_{CC} = 400\text{ V}, I_C = 60\text{ A},$<br>$R_G = 3\ \Omega, V_{GE} = 15\text{ V},$<br>Inductive Load, $T_C = 175^\circ\text{C}$ | – | 18   | –    | ns |
| $T_r$        | Rise Time                |  | – | 41   | –    | ns |
| $T_{d(off)}$ | Turn-Off Delay Time      |  | – | 115  | –    | ns |
| $T_f$        | Fall Time                |  | – | 48   | –    | ns |
| $E_{on}$     | Turn-On Switching Loss   |  | – | 2.1  | –    | mJ |
| $E_{off}$    | Turn-Off Switching Loss  |  | – | 0.78 | –    | mJ |
| $E_{ts}$     | Total Switching Loss     |  | – | 2.88 | –    | mJ |
| $Q_g$        | Total Gate Charge        | $V_{CE} = 400\text{ V}, I_C = 60\text{ A},$<br>$V_{GE} = 15\text{ V}$  | – | 189  | 284  | nC |
| $Q_{ge}$     | Gate to Emitter Charge   |  | – | 20   | 30   | nC |
| $Q_{gc}$     | Gate to Collector Charge |  | – | 91   | 137  | nC |

Product parametric performance is indicated in the Electrical Characteristics for the listed test conditions, unless otherwise noted. Product performance may not be indicated by the Electrical Characteristics if operated under different conditions.

# FGH60N60SMD

## ELECTRICAL CHARACTERISTICS OF THE DIODE ( $T_C = 25^\circ\text{C}$ unless otherwise noted)

| Symbol    | Parameter                     | Test Conditions  | Min                       | Typ | Max | Unit |               |
|-----------|-------------------------------|--|---------------------------|-----|-----|------|---------------|
| $V_{FM}$  | Diode Forward Voltage         | $I_F = 30\text{ A}$  | $T_C = 25^\circ\text{C}$  | -   | 2.1 | 2.7  | V             |
|           |                               |  | $T_C = 175^\circ\text{C}$ | -   | 1.7 | -    |               |
| $E_{rec}$ | Reverse Recovery Energy       | $I_F = 30\text{ A},$<br>$di_F/dt = 200\text{ A}/\mu\text{s}$ | $T_C = 175^\circ\text{C}$ | -   | 79  | -    | $\mu\text{J}$ |
| $T_{rr}$  | Diode Reverse Recovery Time   |  | $T_C = 25^\circ\text{C}$  | -   | 30  | 39   | ns            |
|           |                               |  | $T_C = 175^\circ\text{C}$ | -   | 72  | -    |               |
| $Q_{rr}$  | Diode Reverse Recovery Charge |  | $T_C = 25^\circ\text{C}$  | -   | 44  | 62   | nC            |
|           |                               | $T_C = 175^\circ\text{C}$                                    | -                         | 238 | -   |      |               |

Product parametric performance is indicated in the Electrical Characteristics for the listed test conditions, unless otherwise noted. Product performance may not be indicated by the Electrical Characteristics if operated under different conditions.

TYPICAL PERFORMANCE CHARACTERISTICS

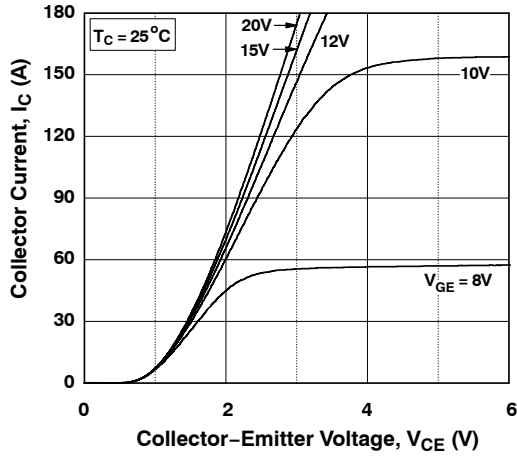

Figure 1. Typical Output Characteristics

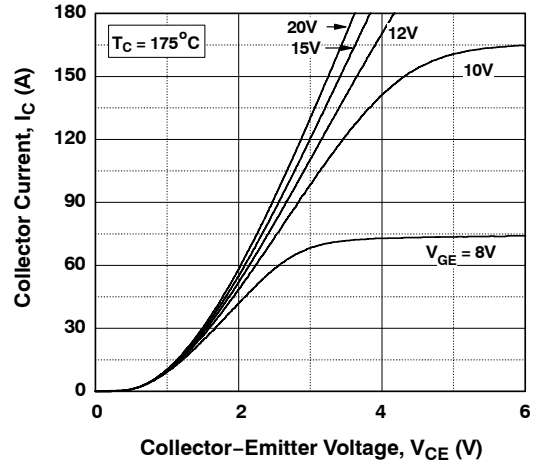

Figure 2. Typical Output Characteristics

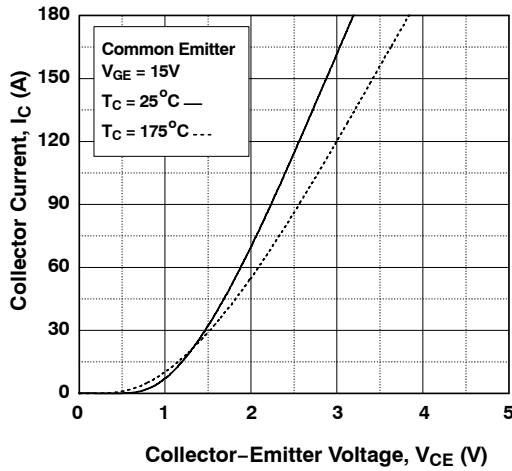

Figure 3. Typical Saturation Voltage Characteristics

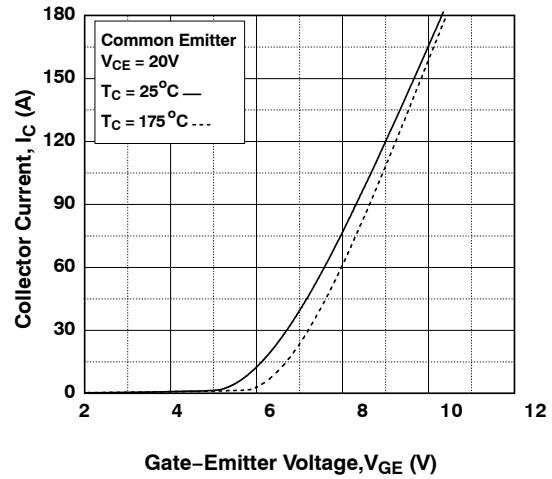

Figure 4. Transfer Characteristics

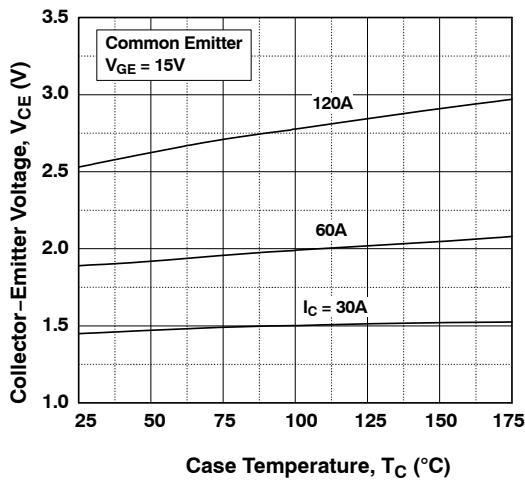

Figure 5. Saturation Voltage vs. Case Temperature at Variant Current Level

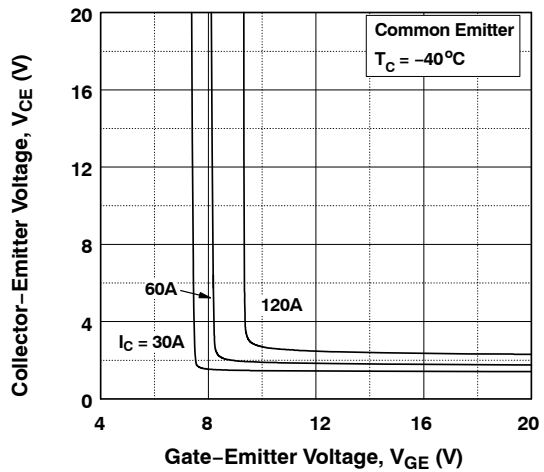

Figure 6. Saturation Voltage vs. Vge

# FGH60N60SMD

## TYPICAL PERFORMANCE CHARACTERISTICS (Continued)

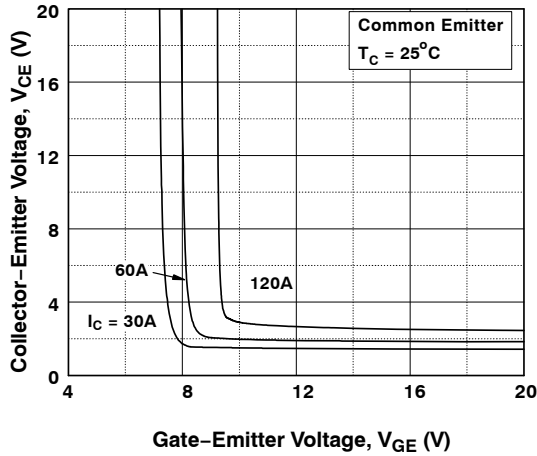

Figure 7. Saturation Voltage vs.  $V_{GE}$

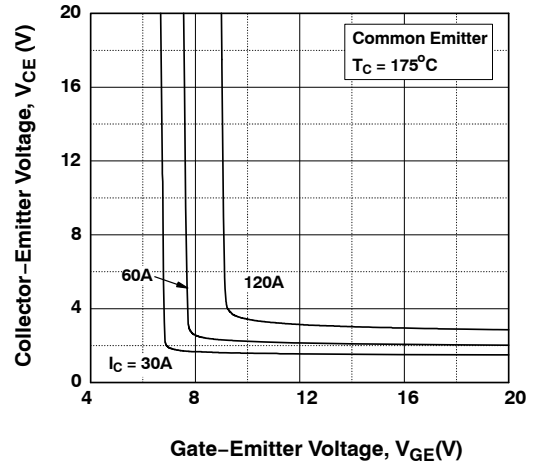

Figure 8. Saturation Voltage vs.  $V_{GE}$

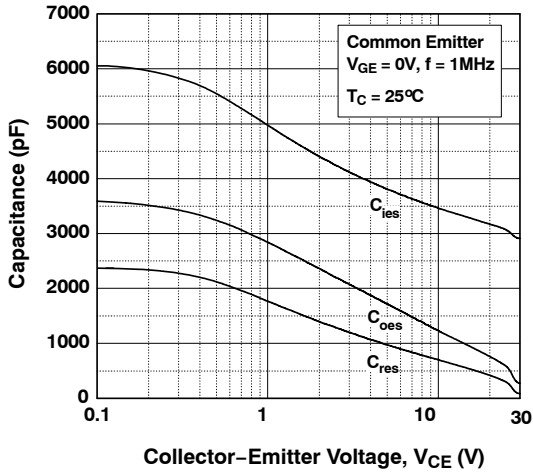

Figure 9. Capacitance Characteristics

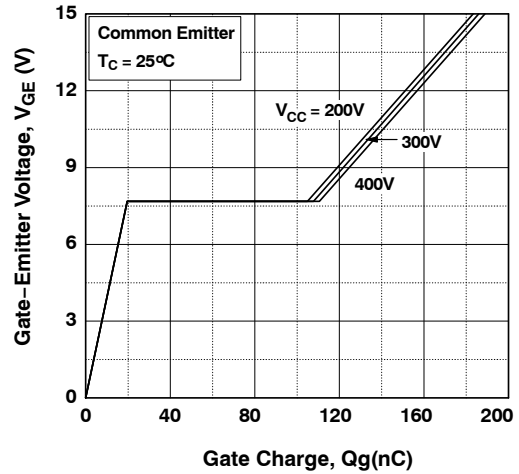

Figure 10. Gate Charge Characteristics

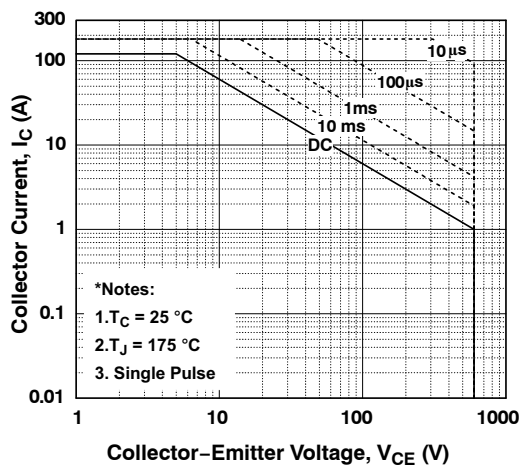

Figure 11. SOA Characteristics

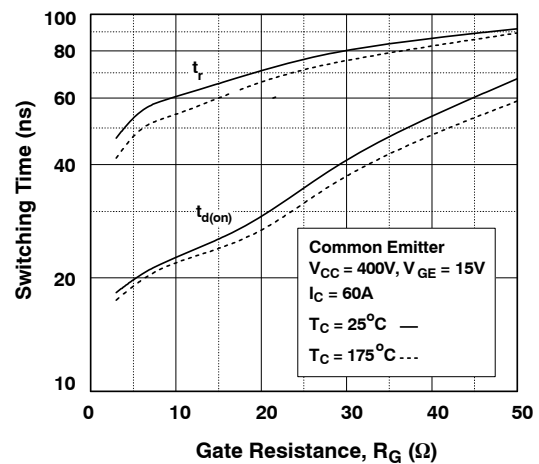

Figure 12. Turn-on Characteristics vs. Gate Resistance

# FGH60N60SMD

## TYPICAL PERFORMANCE CHARACTERISTICS (Continued)

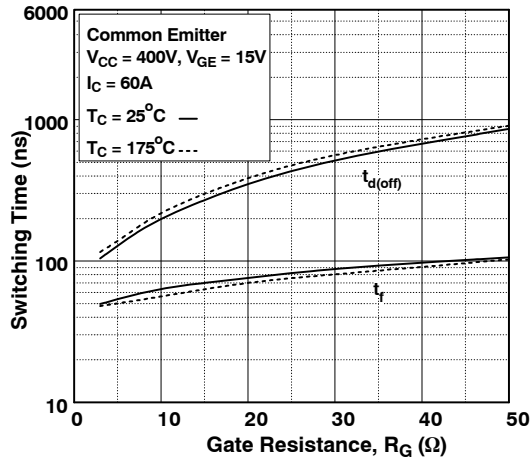

Figure 13. Turn-off Characteristics vs. Gate Resistance

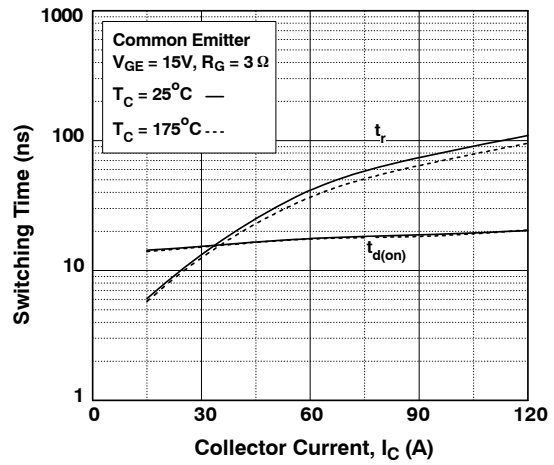

Figure 14. Turn-on Characteristics vs. Collector Current

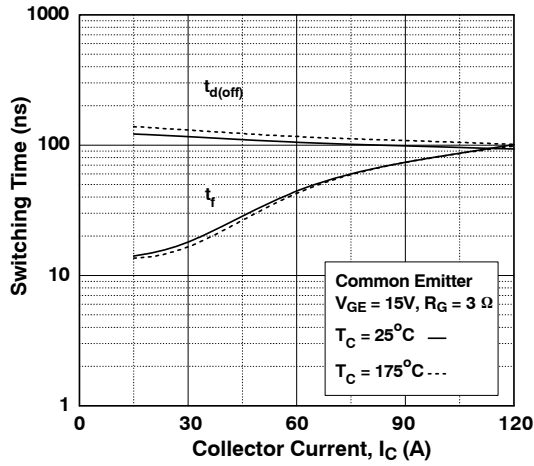

Figure 15. Turn-off Characteristics vs. Collector Current

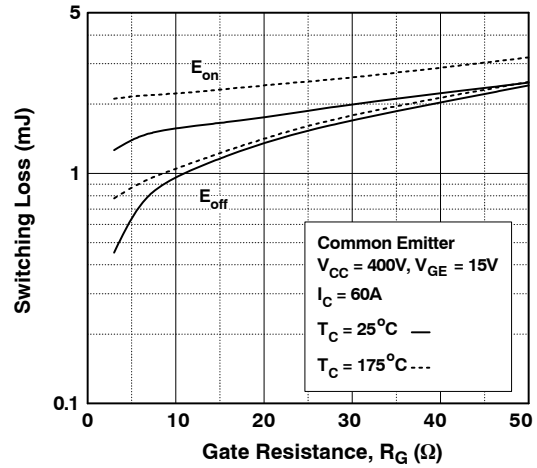

Figure 16. Switching Loss vs. Gate Resistance

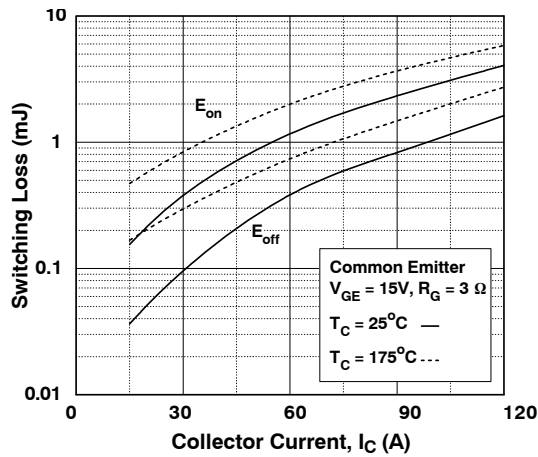

Figure 17. Switching Loss vs. Collector Current

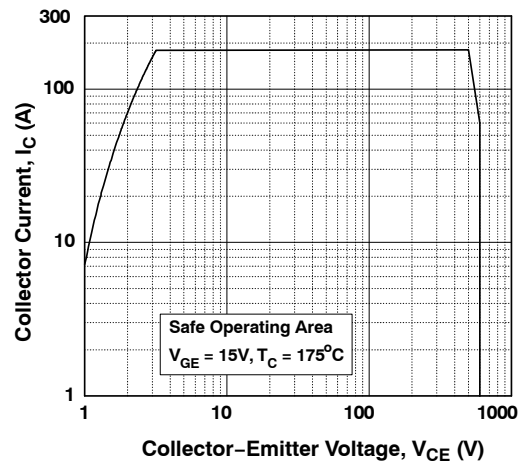

Figure 18. Turn Off Switching SOA Characteristics

# FGH60N60SMD

## TYPICAL PERFORMANCE CHARACTERISTICS (Continued)

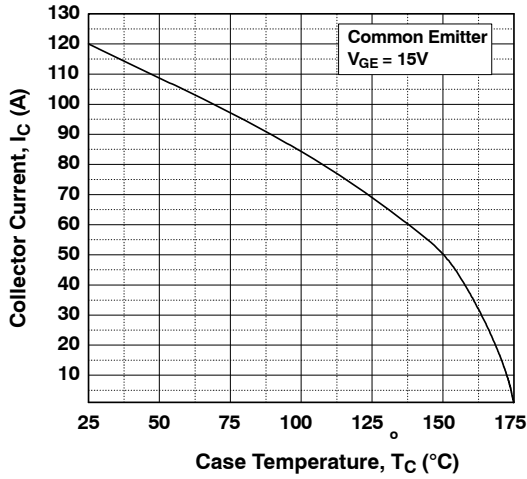

Figure 19. Current Derating

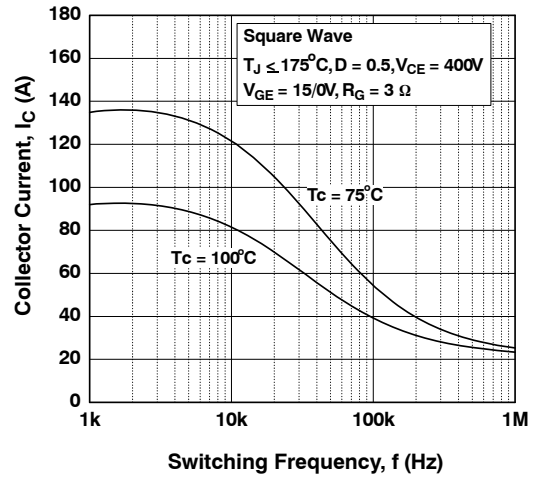

Figure 20. Load Current vs. Frequency

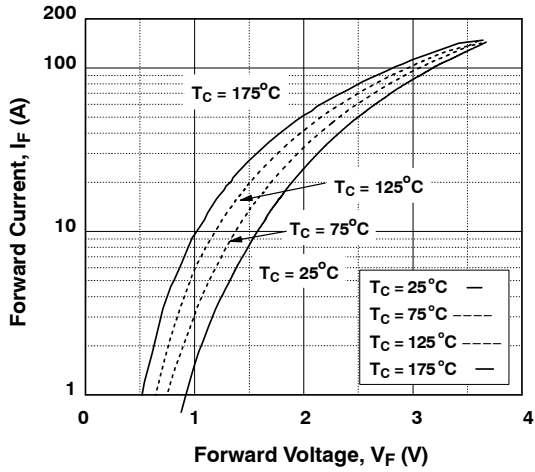

Figure 21. Forward Characteristics

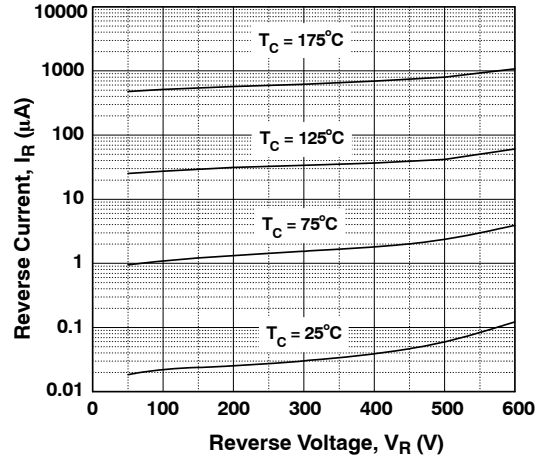

Figure 22. Reverse Current

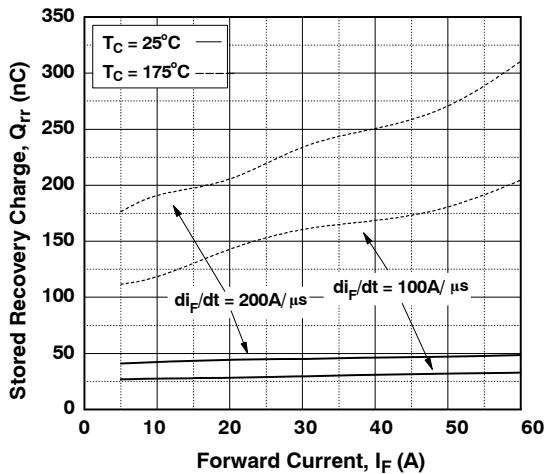

Figure 23. Stored Charge

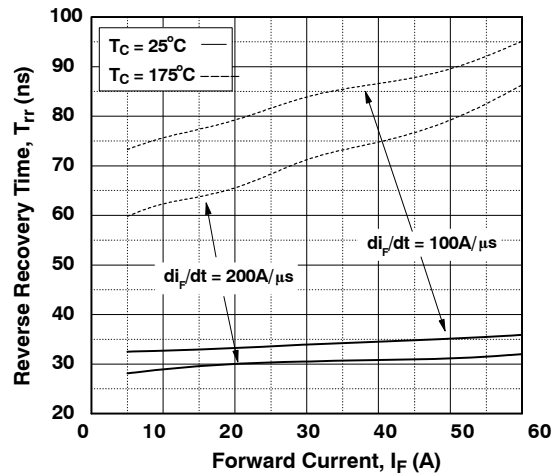

Figure 24. Reverse Recovery Time

# FGH60N60SMD

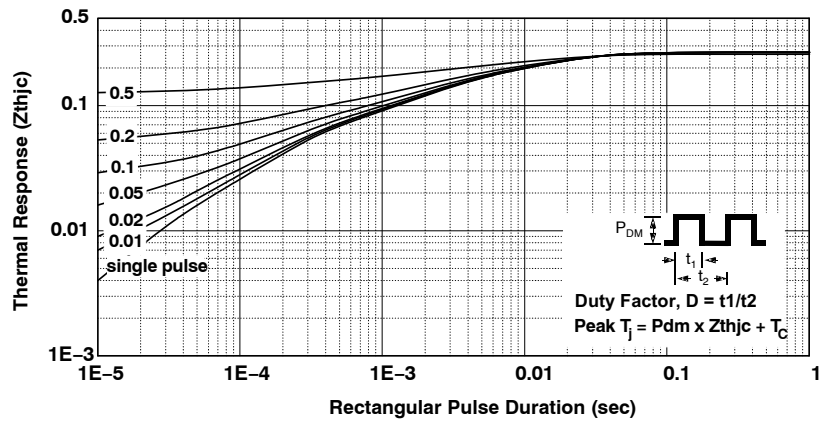

Figure 25. Transient Thermal Impedance of IGBT

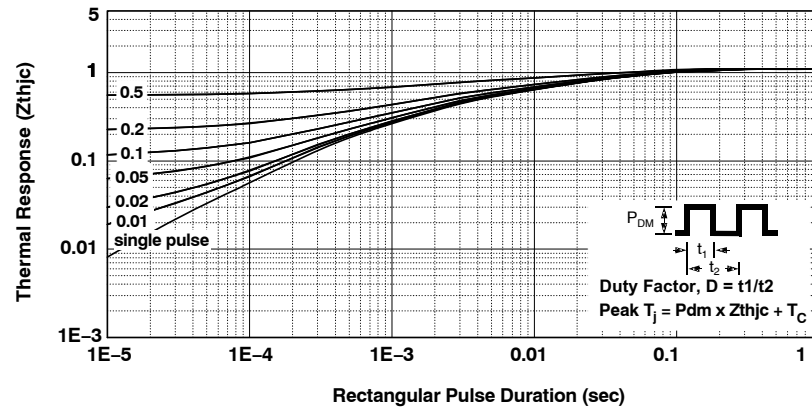
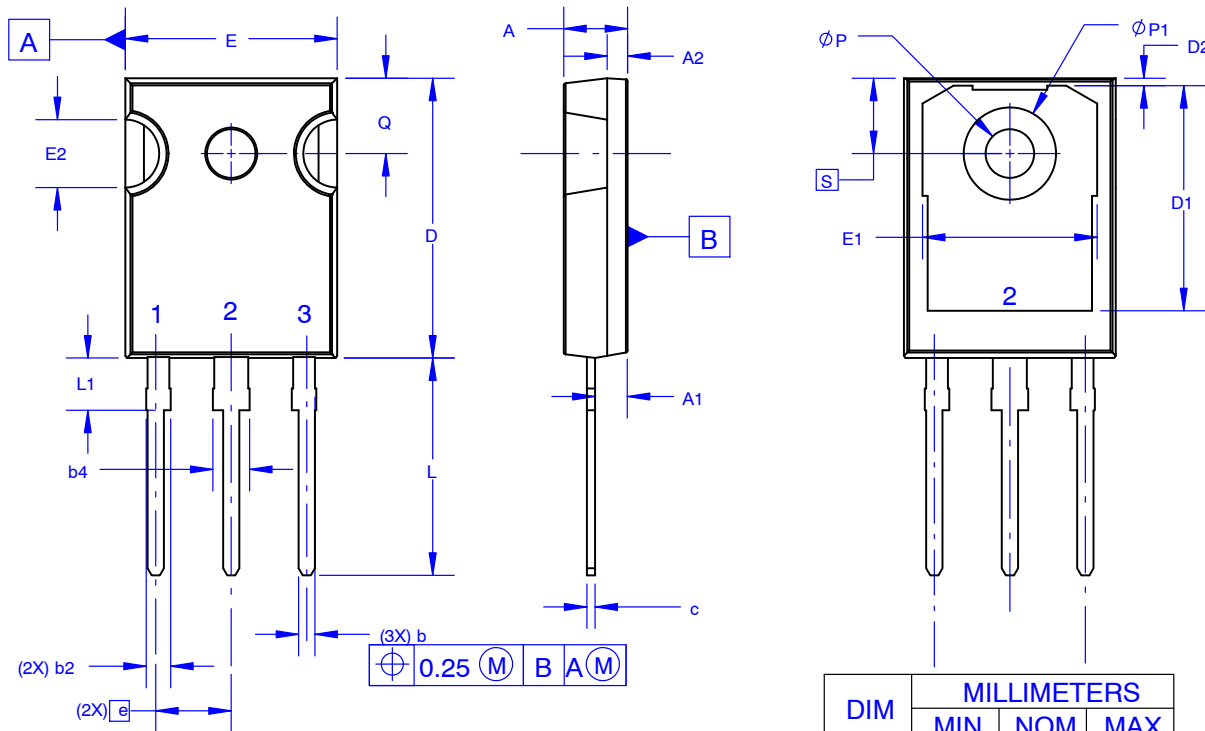

Figure 26. Transient Thermal Impedance of Diode



**TO-247-3LD SHORT LEAD**  
**CASE 340CK**  
**ISSUE A**

DATE 31 JAN 2019



NOTES: UNLESS OTHERWISE SPECIFIED.

- A. DIMENSIONS ARE EXCLUSIVE OF BURRS, MOLD FLASH, AND TIE BAR EXTRUSIONS.
- B. ALL DIMENSIONS ARE IN MILLIMETERS.
- C. DRAWING CONFORMS TO ASME Y14.5 - 2009.
- D. DIMENSION A1 TO BE MEASURED IN THE REGION DEFINED BY L1.
- E. LEAD FINISH IS UNCONTROLLED IN THE REGION DEFINED BY L1.

**GENERIC MARKING DIAGRAM\***

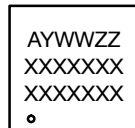

- XXXX = Specific Device Code
- A = Assembly Location
- Y = Year
- WW = Work Week
- ZZ = Assembly Lot Code

\*This information is generic. Please refer to device data sheet for actual part marking. Pb-Free indicator, "G" or microdot "•", may or may not be present. Some products may not follow the Generic Marking.

| DIM | MILLIMETERS |       |       |
|-----|-------------|-------|-------|
|     | MIN         | NOM   | MAX   |
| A   | 4.58        | 4.70  | 4.82  |
| A1  | 2.20        | 2.40  | 2.60  |
| A2  | 1.40        | 1.50  | 1.60  |
| b   | 1.17        | 1.26  | 1.35  |
| b2  | 1.53        | 1.65  | 1.77  |
| b4  | 2.42        | 2.54  | 2.66  |
| c   | 0.51        | 0.61  | 0.71  |
| D   | 20.32       | 20.57 | 20.82 |
| D1  | 13.08       | ~     | ~     |
| D2  | 0.51        | 0.93  | 1.35  |
| E   | 15.37       | 15.62 | 15.87 |
| E1  | 12.81       | ~     | ~     |
| E2  | 4.96        | 5.08  | 5.20  |
| e   | ~           | 5.56  | ~     |
| L   | 15.75       | 16.00 | 16.25 |
| L1  | 3.69        | 3.81  | 3.93  |
| ØP  | 3.51        | 3.58  | 3.65  |
| ØP1 | 6.60        | 6.80  | 7.00  |
| Q   | 5.34        | 5.46  | 5.58  |
| S   | 5.34        | 5.46  | 5.58  |

|                         |                       |  |
|-------------------------|-----------------------|--|
| <b>DOCUMENT NUMBER:</b> | 98AON13851G           | Electronic versions are uncontrolled except when accessed directly from the Document Repository. Printed versions are uncontrolled except when stamped "CONTROLLED COPY" in red. |
| <b>DESCRIPTION:</b>     | TO-247-3LD SHORT LEAD | <b>PAGE 1 OF 1</b>   |

ON Semiconductor and are trademarks of Semiconductor Components Industries, LLC dba ON Semiconductor or its subsidiaries in the United States and/or other countries. ON Semiconductor reserves the right to make changes without further notice to any products herein. ON Semiconductor makes no warranty, representation or guarantee regarding the suitability of its products for any particular purpose, nor does ON Semiconductor assume any liability arising out of the application or use of any product or circuit, and specifically disclaims any and all liability, including without limitation special, consequential or incidental damages. ON Semiconductor does not convey any license under its patent rights nor the rights of others.

**onsemi**, **Onsemi**, and other names, marks, and brands are registered and/or common law trademarks of Semiconductor Components Industries, LLC dba "**onsemi**" or its affiliates and/or subsidiaries in the United States and/or other countries. **onsemi** owns the rights to a number of patents, trademarks, copyrights, trade secrets, and other intellectual property. A listing of **onsemi**'s product/patent coverage may be accessed at [www.onsemi.com/site/pdf/Patent-Marking.pdf](http://www.onsemi.com/site/pdf/Patent-Marking.pdf). **onsemi** reserves the right to make changes at any time to any products or information herein, without notice. The information herein is provided "as-is" and **onsemi** makes no warranty, representation or guarantee regarding the accuracy of the information, product features, availability, functionality, or suitability of its products for any particular purpose, nor does **onsemi** assume any liability arising out of the application or use of any product or circuit, and specifically disclaims any and all liability, including without limitation special, consequential or incidental damages. Buyer is responsible for its products and applications using **onsemi** products, including compliance with all laws, regulations and safety requirements or standards, regardless of any support or applications information provided by **onsemi**. "Typical" parameters which may be provided in **onsemi** data sheets and/or specifications can and do vary in different applications and actual performance may vary over time. All operating parameters, including "Typicals" must be validated for each customer application by customer's technical experts. **onsemi** does not convey any license under any of its intellectual property rights nor the rights of others. **onsemi** products are not designed, intended, or authorized for use as a critical component in life support systems or any FDA Class 3 medical devices or medical devices with a same or similar classification in a foreign jurisdiction or any devices intended for implantation in the human body. Should Buyer purchase or use **onsemi** products for any such unintended or unauthorized application, Buyer shall indemnify and hold **onsemi** and its officers, employees, subsidiaries, affiliates, and distributors harmless against all claims, costs, damages, and expenses, and reasonable attorney fees arising out of, directly or indirectly, any claim of personal injury or death associated with such unintended or unauthorized use, even if such claim alleges that **onsemi** was negligent regarding the design or manufacture of the part. **onsemi** is an Equal Opportunity/Affirmative Action Employer. This literature is subject to all applicable copyright laws and is not for resale in any manner.

## ADDITIONAL INFORMATION

### TECHNICAL PUBLICATIONS:

Technical Library: [www.onsemi.com/design/resources/technical-documentation](http://www.onsemi.com/design/resources/technical-documentation)  
onsemi Website: [www.onsemi.com](http://www.onsemi.com)

### ONLINE SUPPORT: [www.onsemi.com/support](http://www.onsemi.com/support)

For additional information, please contact your local Sales Representative at [www.onsemi.com/support/sales](http://www.onsemi.com/support/sales)

## Looking for pricing, stock, or lifecycle information?

Click below to explore more details on WIN SOURCE:

-  [View FGH60N60SMD on WIN SOURCE](#)
-  [Fairchild/ON Semiconductor Information](#)

## Optimize Your Supply Chain with WIN SOURCE Solutions

-  Global Sourcing Solution
-  Obsolete Management
-  Cost Control Management
-  Shortage Management
-  Alternative Solution
-  Excess Inventory Management