

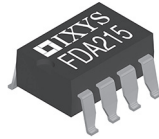

THE DATASHEET OF FDA215STR





Parameter	Rating	Units
Typical Open Circuit Voltage	5.5	V
Typical Short Circuit Current	2.5	μA
Input Control Current	5	mA

Features

- Optically Isolated, Input to Output
- Dual Independent, Floating Outputs for Parallel, Series, or Isolated Configuration
- 5mA Control Current
- May Be Configured for AC and DC Switching
- Replacement of Discrete Components
- VDE Compatible
- Solid State Reliability
- No EMI/RFI Generation
- Surface Mount and Tape & Reel Version Available
- Flammability Rating UL 94 V-0

Applications

- MOSFET Driver
- Programmable Control
- Process Control
- Instrumentation
- Telecommunications

Description

The FDA215 is a dual photovoltaic MOSFET driver that uses a pair of optically coupled LEDs to drive two photodiode arrays. When the input current is applied to the LED, the light emitted activates the photodiode array, and generates a voltage at the output. The photodiode arrays are capable of generating a floating source voltage and current sufficient to drive high power MOSFET transistors. The optical coupling provides a high level of input to output isolation. The FDA215 is well suited for use in discrete solid state relay designs and other isolated switching applications.

Approvals

- EN/IEC 60950-1 Certified Component:
Certificate available on our website

Ordering Information

Part #	Description
FDA215	8-Pin DIP (50/tube)
FDA215S	8-Pin Surface Mount (50/tube)
FDA215STR	8-Pin Surface Mount (1000/reel)

Pin Configuration

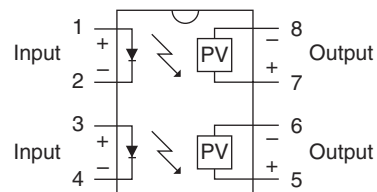

Absolute Maximum Ratings @ 25°C

Parameter	Ratings	Units
Reverse Input Voltage	5	V
Input Control Current Peak (10ms)	100	mA
	1	A
Input Power Dissipation ¹	150	mW
Total Power Dissipation ²	500	mW
Capacitance, Input to Output	1	pF
Isolation Voltage, Input to Output	3750	V _{rms}
Operational Temperature	-40 to +85	°C
Storage Temperature	-40 to +125	°C

¹ Derate linearly 1.33 mW / °C

² Derate linearly 6.67 mW / °C

Absolute Maximum Ratings are stress ratings. Stresses in excess of these ratings can cause permanent damage to the device. Functional operation of the device at conditions beyond those indicated in the operational sections of this data sheet is not implied.

Typical values are characteristic of the device at +25°C, and are the result of engineering evaluations. They are provided for information purposes only, and are not part of the manufacturing testing requirements.

Electrical Characteristics @ 25°C

Parameter	Conditions	Symbol	Min	Typ	Max	Units
Output Characteristics						
Open Circuit Voltage	I _F =5mA	V _{OC}	3	5.5	8	V
Short Circuit Current	I _F =5mA	I _{SC}	1	2.5	9	μA
	I _F =25mA		2.5	3.5	20	
Switching Speeds	I _F =5mA, C _{LOAD} =200pF	t _{on}	-	-	5	ms
Turn-Off			t _{off}	-	-	
Offstate Clamping Resistance	V _L =1V	R _{CL}	100	250	3300	Ω
Input Characteristics						
Input Control Current	-	I _F	-	-	5	mA
Input Voltage Drop	I _F =5mA	V _F	0.9	1.2	1.5	V
Reverse Input Current	V _R =5V	I _R	-	-	10	μA
Common Characteristics						
Capacitance, Input to Output	V _{IO} =0V, f=1MHz	C _{IO}	-	3	-	pF

PERFORMANCE DATA*

LED Forward Voltage Drop vs. Temperature

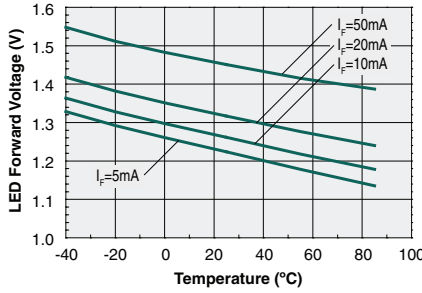

LED Forward Voltage vs. Forward Current (Room Temperature)

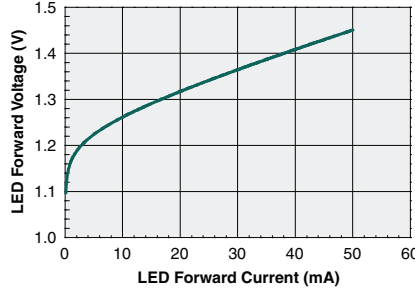

On-Resistance vs. Temperature (V_LOAD=1V, Internal to Photovoltaic Driver)

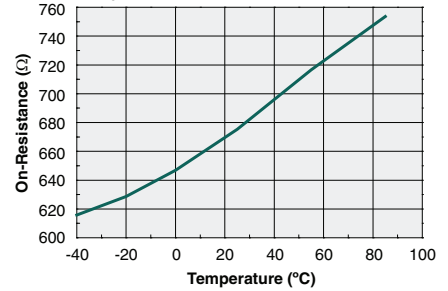

Turn-On Time vs. LED Current (V_OUT=5V, C=200pF)

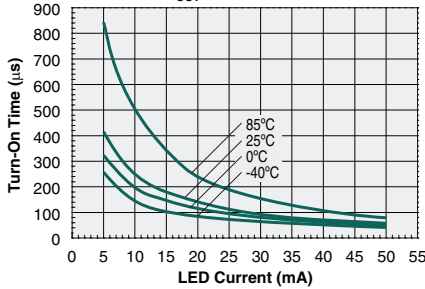

Turn-On Time vs. Temperature (V_OUT=5V, C_OUT=200pF)

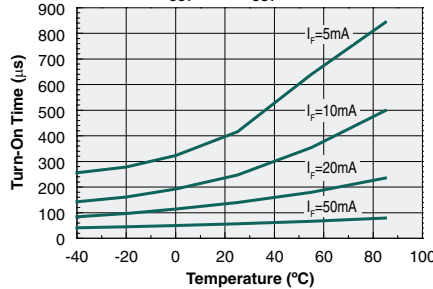

Turn-On Time vs. Capacitance (V_OUT=5V)

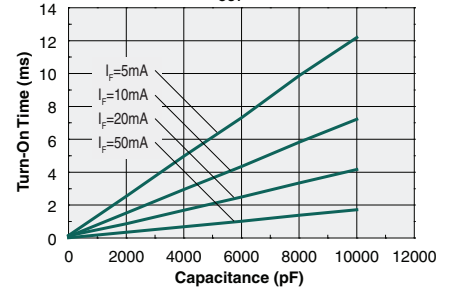

Turn-Off Time vs. LED Current (V_OUT=1V, C=200pF)

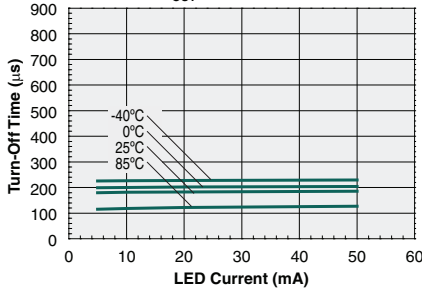

Turn-Off Time vs. Temperature (V_OUT=1V, C_OUT=200pF)

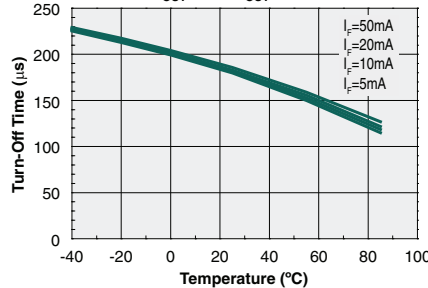

Turn-Off Time vs. Capacitance (V_OUT=1V)

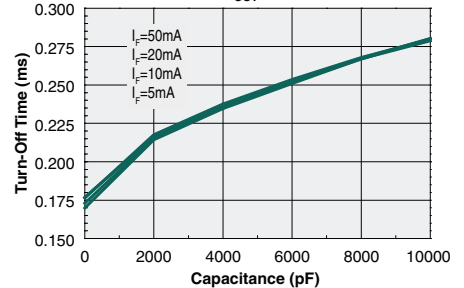

Open Circuit Voltage vs. Temperature

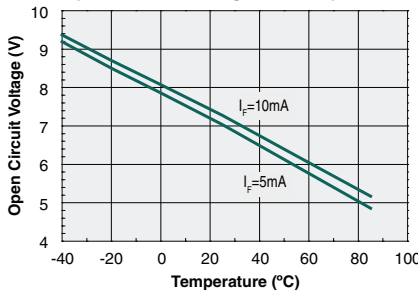

Short Circuit Current vs. Temperature

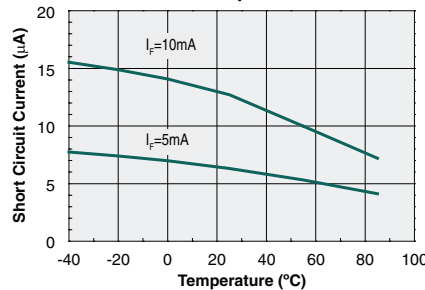

Output Current vs. Output Voltage

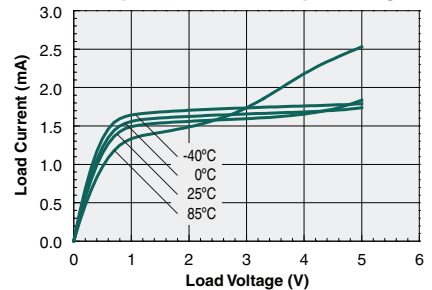

*Unless otherwise noted, data presented in these graphs is typical of device operation at 25°C. For guaranteed parameters not indicated in the written specifications, please contact our application department.

Manufacturing Information

Moisture Sensitivity



All plastic encapsulated semiconductor packages are susceptible to moisture ingress. IXYS Integrated Circuits classifies its plastic encapsulated devices for moisture sensitivity according to the latest version of the joint industry standard, **IPC/JEDEC J-STD-020**, in force at the time of product evaluation. We test all of our products to the maximum conditions set forth in the standard, and guarantee proper operation of our devices when handled according to the limitations and information in that standard as well as to any limitations set forth in the information or standards referenced below.

Failure to adhere to the warnings or limitations as established by the listed specifications could result in reduced product performance, reduction of operable life, and/or reduction of overall reliability.

This product carries a Moisture Sensitivity Level (MSL) classification as shown below, and should be handled according to the requirements of the latest version of the joint industry standard **IPC/JEDEC J-STD-033**.

Device	Moisture Sensitivity Level (MSL) Classification
FDA215 / FDA215S	MSL 1

ESD Sensitivity



This product is **ESD Sensitive**, and should be handled according to the industry standard **JESD-625**.

Soldering Profile

Provided in the table below is the Classification Temperature (T_C) of this product and the maximum dwell time the body temperature of this device may be ($T_C - 5$)°C or greater. The classification temperature sets the Maximum Body Temperature allowed for this device during lead-free reflow processes. For through-hole devices, and any other processes, the guidelines of **J-STD-020** must be observed.

Device	Classification Temperature (T_C)	Dwell Time (t_p)	Max Reflow Cycles
FDA215S	250°C	30 seconds	3
FDA215	250°C	30 seconds	1

Board Wash

IXYS Integrated Circuits recommends the use of no-clean flux formulations. Board washing to reduce or remove flux residue following the solder reflow process is acceptable provided proper precautions are taken to prevent damage to the device. These precautions include, but are not limited to: using a low pressure wash and providing a follow up bake cycle sufficient to remove any moisture trapped within the device due to the washing process. Due to the variability of the wash parameters used to clean the board, determination of the bake temperature and duration necessary to remove the moisture trapped within the package is the responsibility of the user (assembler). Cleaning or drying methods that employ ultrasonic energy may damage the device and should not be used. Additionally, the device must not be exposed to flux or solvents that are Chlorine- or Fluorine-based.



MECHANICAL DIMENSIONS

FDA215S

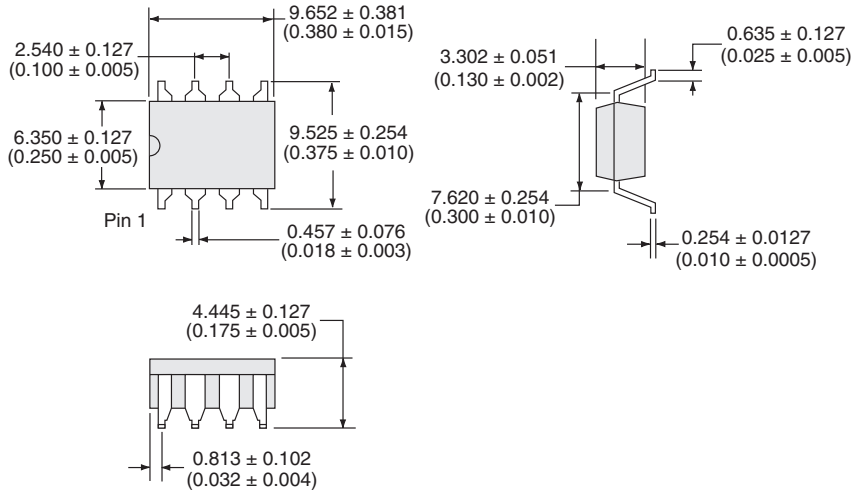

PCB Land Pattern

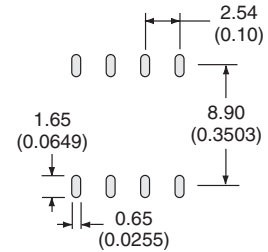

Dimensions
mm
(inches)

FDA215STR Tape & Reel

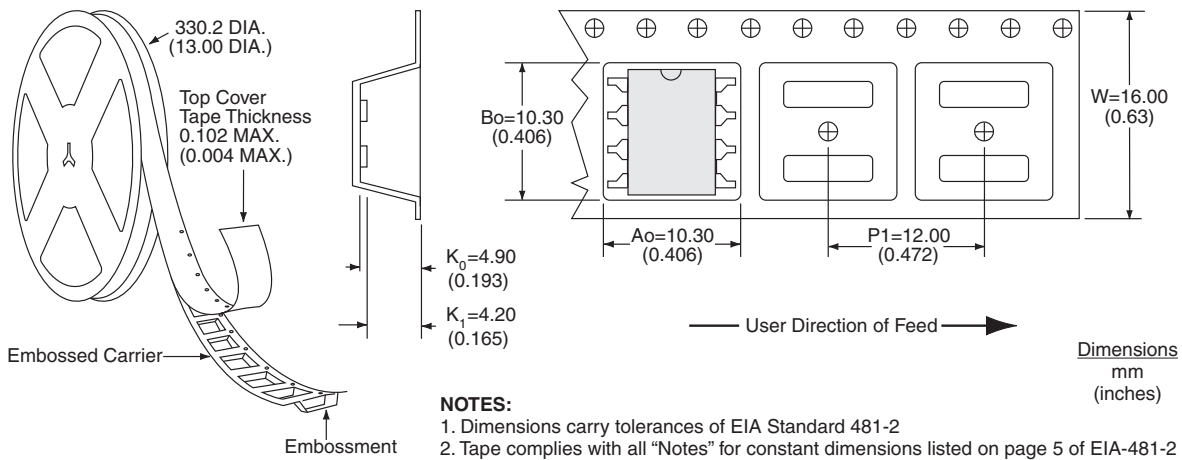

FDA215

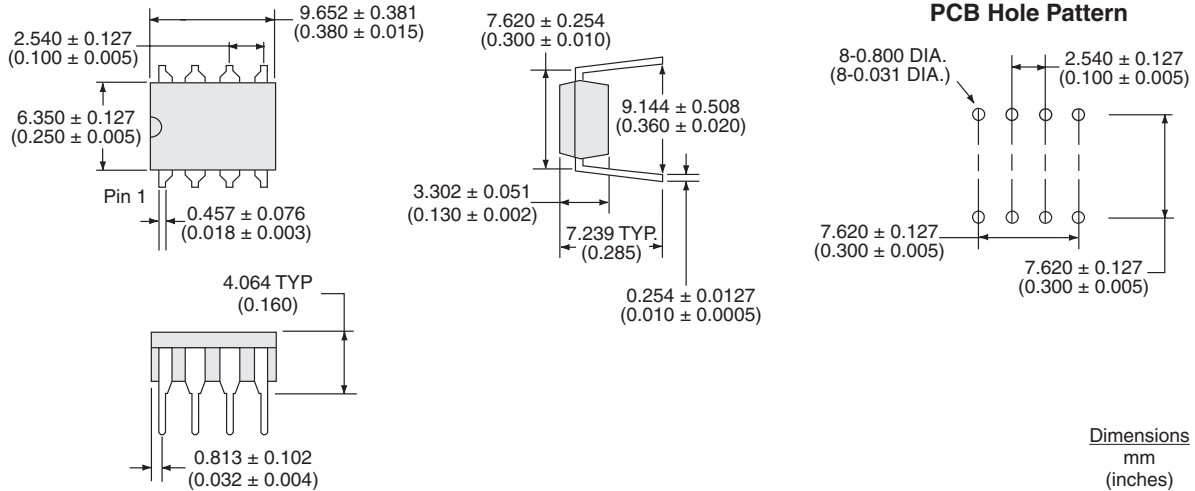

For additional information please visit our website at: www.ixysic.com

IXYS Integrated Circuits makes no representations or warranties with respect to the accuracy or completeness of the contents of this publication and reserves the right to make changes to specifications and product descriptions at any time without notice. Neither circuit patent licenses nor indemnity are expressed or implied. Except as set forth in IXYS Integrated Circuits' Standard Terms and Conditions of Sale, IXYS Integrated Circuits assumes no liability whatsoever, and disclaims any express or implied warranty, relating to its products including, but not limited to, the implied warranty of merchantability, fitness for a particular purpose, or infringement of any intellectual property right.

The products described in this document are not designed, intended, authorized or warranted for use as components in systems intended for surgical implant into the body, or in other applications intended to support or sustain life, or where malfunction of IXYS Integrated Circuits' product may result in direct physical harm, injury, or death to a person or severe property or environmental damage. IXYS Integrated Circuits reserves the right to discontinue or make changes to its products at any time without notice.

Looking for pricing, stock, or lifecycle information?

Click below to explore more details on WIN SOURCE:

 [View FDA215STR](#) on WIN SOURCE

 [IXYS](#) Information

Optimize Your Supply Chain with WIN SOURCE Solutions

-  Global Sourcing Solution
-  Obsolete Management
-  Cost Control Management
-  Shortage Management
-  Alternative Solution
-  Excess Inventory Management