

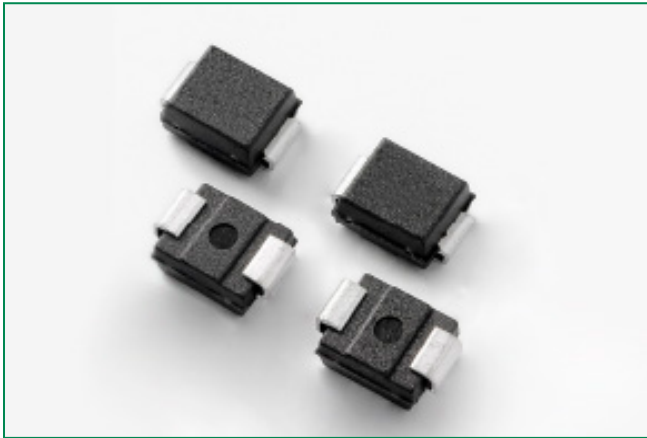

**THE DATASHEET OF
1SMB10CAT3G**



1SMB10CAT3G Series



Maximum Ratings and Thermal Characteristics

Parameter	Symbol	Value	Unit
Peak Power Dissipation (Note 1) @ $T_L = 25^\circ\text{C}$, Pulse Width = 1 ms	P_{PK}	600	W
DC Power Dissipation @ $T_L = 75^\circ\text{C}$ Measured Zero Lead Length (Note 2) Derate Above 75°C	P_D	3.0 40	W mW/ $^\circ\text{C}$
Thermal Resistance from Junction-to-Lead	R _{JL}	25	$^\circ\text{C}/\text{W}$
DC Power Dissipation (Note 3) @ $T_A = 25^\circ\text{C}$ Derate Above 25°C	P_D	0.55 4.4	W mW/ $^\circ\text{C}$
Thermal Resistance from Junction-to-Ambient	R _{θJA}	226	$^\circ\text{C}/\text{W}$
Operating and Storage Temperature Range	T_J, T_{stg}	-65 to +150	$^\circ\text{C}$

Stresses exceeding Maximum Ratings may damage the device. Maximum Ratings are stress ratings only. Functional operation above the Recommended Operating Conditions is not implied. Extended exposure to stresses above the Recommended Operating Conditions may affect device reliability.

- 10 X 1000 μs , non-repetitive
- 1" square copper pad, FR-4 board
- FR-4 board, using Littelfuse minimum recommended footprint, as shown in 403A-03 case outline dimensions spec

*Please see 1SMB5.0AT3 to 1SMB170AT3 for Unidirectional devices

Description

The 1SMB10CAT3Gv series is designed to protect voltage sensitive components from high voltage, high energy transients. They have excellent clamping capability, high surge capability, low zener impedance and fast response time. The 1SMB10CAT3G series is supplied in the Littelfuse exclusive, cost-effective, highly reliable package and is ideally suited for use in communication systems, automotive, numerical controls, process controls, medical equipment, business machines, power supplies and many other industrial/consumer applications.

Features

- Working Peak Reverse Voltage Range – 10 V to 75 V
- Standard Zener Breakdown Voltage Range – 11.7 V to 91.7 V
- Peak Power – 600 Watts @ 1 ms
- ESD Rating of Class 3 (> 16 kV) per Human Body Model
- Maximum Clamp Voltage @ Peak Pulse Current
- Low Leakage < 5 μA Above 10 V
- UL 497B for Isolated Loop Circuit Protection
- Response Time is Typically < 1 ns
- Pb-Free Packages are Available

Functional Diagram

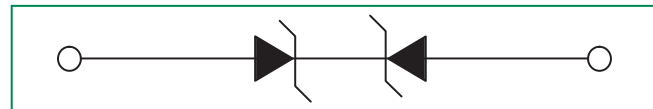

Additional Information



Datasheet



Resources



Samples

I-V Curve Characteristics ($T_A = 25^\circ\text{C}$ unless otherwise noted)

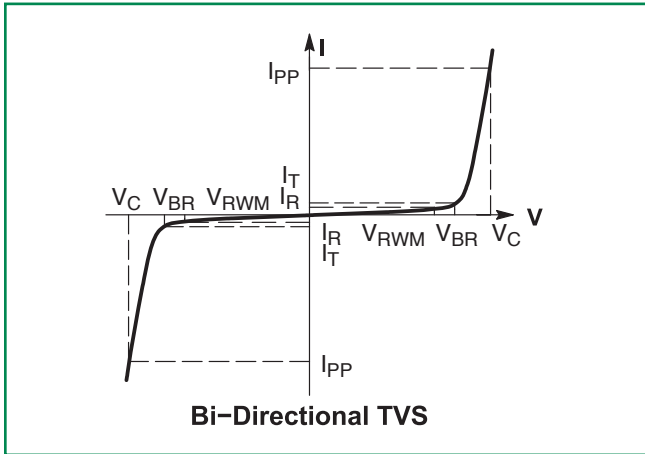

Symbol	Parameter
I_{PP}	Maximum Reverse Peak Pulse Current
V_C	Clamping Voltage @ I_{PP}
V_{RWM}	Working Peak Reverse Voltage
I_R	Maximum Reverse Leakage Current @ V_{RWM}
V_{BR}	Breakdown Voltage @ I_T
I_T	Test Current

Electrical Characteristics

Device*	Device Marking	V _{RWM} (Note 6)	I _R @ V _{RWM}	Breakdown Voltage				V _C @ I _{PP} (Note 8)		C Typ. (Note 9)
				V _{BR} @ I _T (V) (Note 7)			@ I _T	V _C	I _{PP}	
				MIN	NOM	MAX	mA	Volts	Amps	
1SMB10CAT3G	KXC	10	5.0	11.1	11.69	12.27	1.0	17.0	35.3	805
1SMB11CAT3G	KZC	11	5.0	12.2	12.84	13.5	1.0	18.2	33.0	740
1SMB12CAT3G	LEC	12	5.0	13.3	14.00	14.7	1.0	19.9	30.2	680
1SMB13CAT3G	LGC	13	5.0	14.4	15.16	15.9	1.0	21.5	27.9	630
1SMB14CAT3G	LKC	14	5.0	15.6	16.42	17.2	1.0	23.2	25.8	590
1SMB15CAT3G	LMC	15	5.0	16.7	17.58	18.5	1.0	24.4	24.0	555
1SMB16CAT3G	LPC	16	5.0	17.8	18.74	19.7	1.0	26.0	23.1	520
1SMB17CAT3G	LRC	17	5.0	18.9	19.90	20.9	1.0	27.6	21.7	490
1SMB18CAT3G	LTC	18	5.0	20.0	21.06	22.1	1.0	29.2	20.5	465
1SMB20CAT3G	LVC	20	5.0	22.2	23.37	24.5	1.0	32.4	18.5	425
1SMB22CAT3G	LXC	22	5.0	24.4	25.69	27.0	1.0	35.5	16.9	390
1SMB24CAT3G	LZC	24	5.0	26.7	28.11	29.5	1.0	38.9	15.4	366
1SMB26CAT3G	MEC	26	5.0	28.9	30.42	31.9	1.0	42.1	14.2	330
1SMB28CAT3G	MGC	28	5.0	31.1	32.74	34.4	1.0	45.4	13.2	310
1SMB30CAT3G	MKC	30	5.0	33.3	35.06	36.8	1.0	48.4	12.4	290
1SMB33CAT3G	MMC	33	5.0	36.7	38.63	40.6	1.0	53.3	11.3	265
1SMB36CAT3G	MPC	36	5.0	40.0	42.11	44.2	1.0	58.1	10.3	245
1SMB40CAT3G	MRC	40	5.0	44.4	46.74	49.1	1.0	64.5	9.3	220
1SMB43CAT3G	MTC	43	5.0	47.8	50.32	52.8	1.0	69.4	8.6	210
1SMB45CAT3G	MVC	45	5.0	50.0	52.63	55.3	1.0	72.2	8.3	200
1SMB48CAT3G	MXC	48	5.0	53.3	56.11	58.9	1.0	77.4	7.7	190
1SMB51CAT3G	MZC	51	5.0	56.7	59.69	62.7	1.0	82.4	7.3	175
1SMB54CAT3G	NEC	54	5.0	60.0	63.16	66.32	1.0	87.1	6.9	170
1SMB58CAT3G	NGC	58	5.0	64.4	67.79	71.18	1.0	93.6	6.4	155
1SMB60CAT3G	NKC	60	5.0	66.7	70.21	73.72	1.0	96.8	6.2	150
1SMB64CAT3G	NMC	64	5.0	71.1	74.84	78.58	1.0	103	5.8	145
1SMB75CAT3G	NRC	75	5.0	83.3	91.65	92.07	1.0	121	4.9	125

4. A transient suppressor is normally selected according to the working peak reverse voltage (V_{RWM}), which should be equal to or greater than the DC or continuous peak operating voltage level.

5. V_{BR} measured at pulse test current I_T at an ambient temperature of 25°C.

6. Surge current waveform per Figure 2 and derate per Figure 3 of the General Data – 600 Watt at the beginning of this group.

7. Bias Voltage = 0 V, F = 1 MHz, T_J = 25°C

Ratings and Characteristic Curves

Figure 1. Pulse Rating Curve

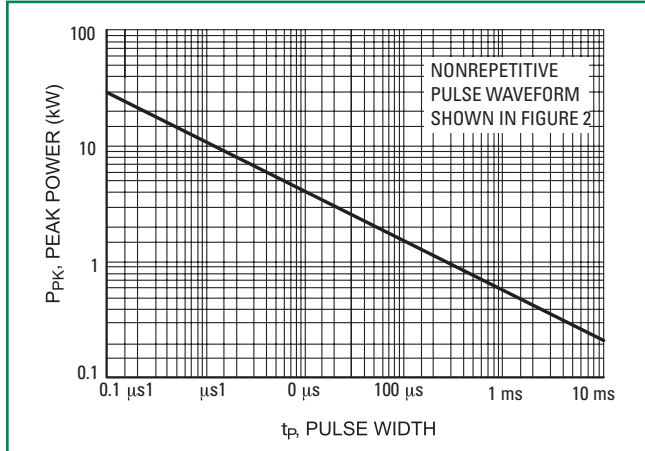

Figure 2. Pulse Waveform

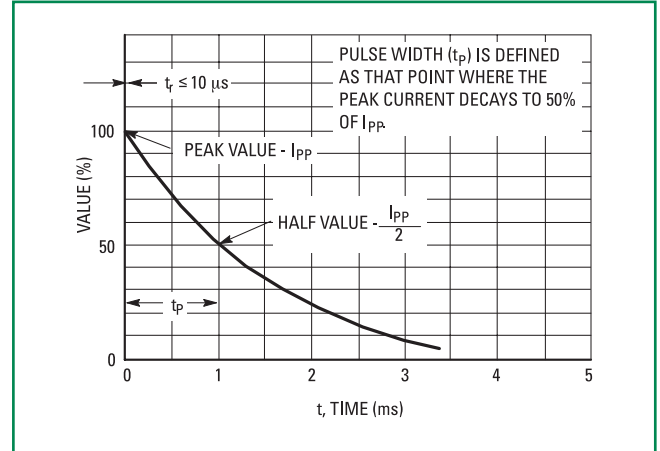

Figure 3. Pulse Derating Curve

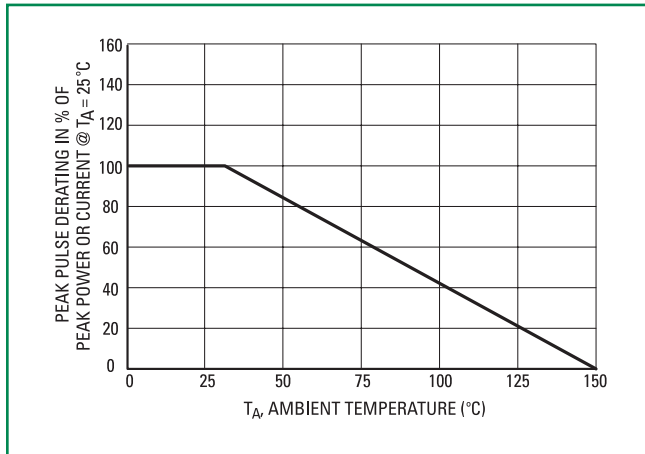
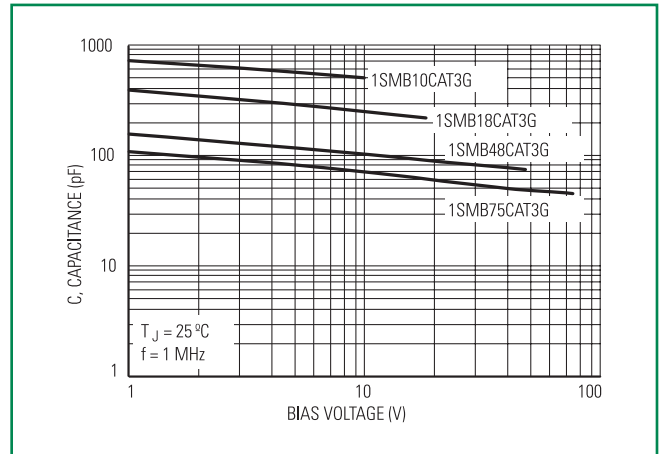
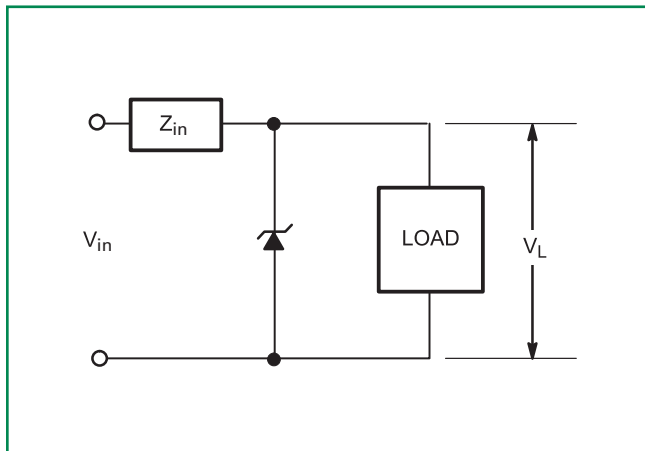

Figure 4. Typical Junction Capacitance vs. Bias Voltage



Typical Protection Circuit



Application Notes

Response Time

In most applications, the transient suppressor device is placed in parallel with the equipment or component to be protected. In this situation, there is a time delay associated with the capacitance of the device and an overshoot condition associated with the inductance of the device and the inductance of the connection method. The capacitive effect is of minor importance in the parallel protection scheme because it only produces a time delay in the transition from the operating voltage to the clamp voltage as shown in Figure 5.

The inductive effects in the device are due to actual turn-on time (time required for the device to go from zero current to full current) and lead inductance. This inductive effect produces an overshoot in the voltage across the equipment or component being protected as shown in Figure 6. Minimizing this overshoot is very important in the application, since the main purpose for adding a transient suppressor is to clamp voltage spikes. The SMB series have a very good response time, typically < 1 ns and negligible inductance. However, external inductive effects could produce unacceptable overshoot. Proper circuit layout minimum lead lengths and placing the suppressor device as close as possible to the equipment or components to be protected will minimize this overshoot.

Some input impedance represented by Z_{in} is essential to prevent overstress of the protection device. This impedance should be as high as possible, without restricting the circuit operation.

Duty Cycle Derating

The data of Figure 1 applies for non-repetitive conditions and at a lead temperature of 25°C. If the duty cycle increases, the peak power must be reduced as indicated by the curves of Figure 7. Average power must be derated as the lead or ambient temperature rises above 25°C. The average power derating curve normally given on data sheets may be normalized and used for this purpose.

At first glance the derating curves of Figure 7 appear to be in error as the 10 ms pulse has a higher derating factor than the 10 s pulse. However, when the derating factor for a given pulse of Figure 7 is multiplied by the peak power value of Figure 1 for the same pulse, the results follow the expected trend.

Figure 5.

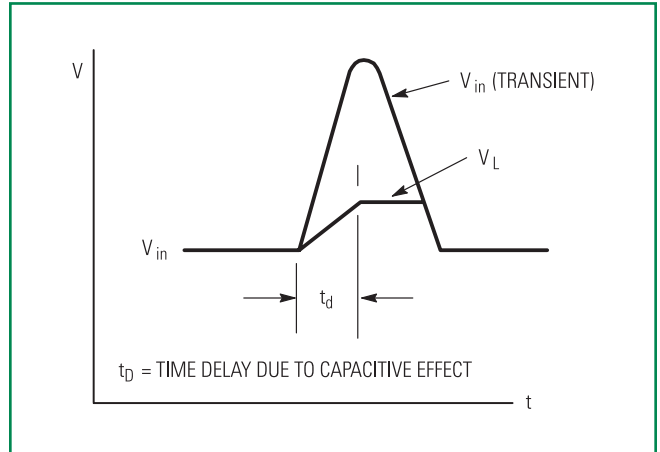

Figure 6.

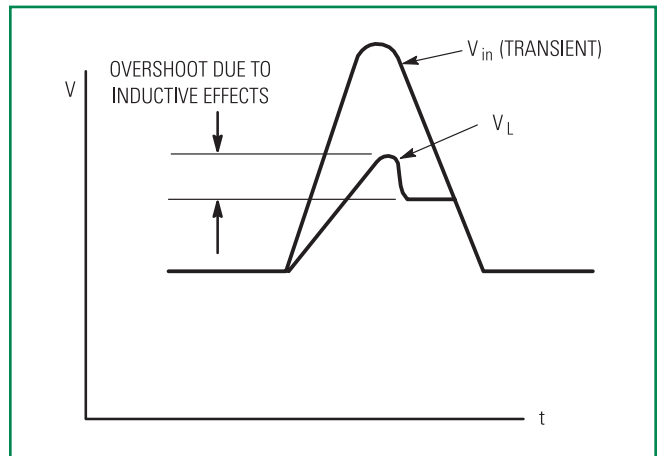
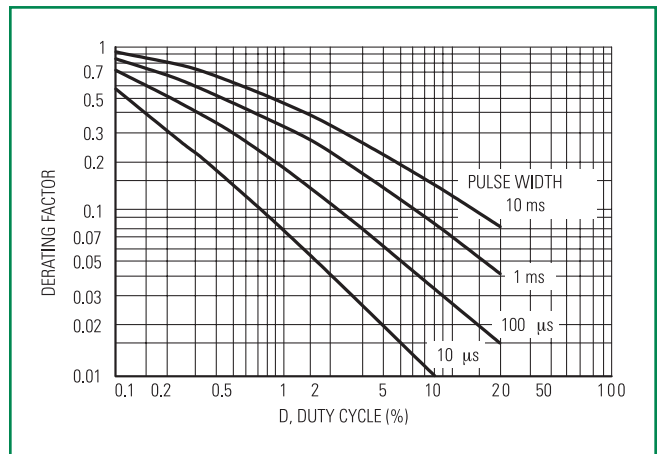
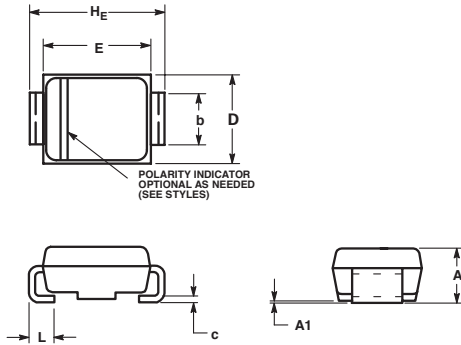

Figure 7. Typical Derating Factor for Duty Cycle



Dimensions



Dim	Inches			Millimeters		
	Min	Nom	Max	Min	Nom	Max
A	0.075	0.087	0.090	1.90	2.20	2.28
A1	0.002	0.004	0.007	0.05	0.10	0.19
b	0.077	0.080	0.087	1.96	2.03	2.20
c	0.006	0.009	0.012	0.15	0.23	0.31
D	0.130	0.140	0.156	3.30	3.56	3.95
E	0.160	0.170	0.181	4.06	4.32	4.60
H _E	0.205	0.214	0.220	5.21	5.44	5.60
L	0.030	0.040	0.063	0.76	1.02	1.60
L1	0.020 REF		0.51 REF			

NOTES:

1. DIMENSIONING AND TOLERANCING PER ANSI Y14.5M, 1982.
2. CONTROLLING DIMENSION: INCH.
3. D DIMENSION SHALL BE MEASURED WITHIN DIMENSION P.

Part Marking System



- A = Assembly Location
- Y = Year
- WW = Work Week
- xxC = Specific Device Code
(See Table on Page 3)
- = Pb-Free Package

(Note: Microdot may be in either location)

Soldering Footprint

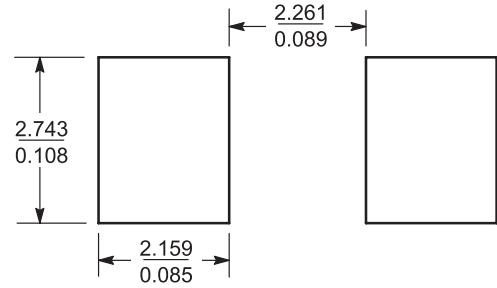

SCALE 8:1 (mm/inches)

ORDERING INFORMATION

Device	Package	Shipping
1SMBxxCAT3G	SMB (Pb-Free)	2,500 / Tape & Reel

Flow/Wave Soldering (Solder Dipping)

Peak Temperature :	260 °C
Dipping Time :	10 seconds



Physical Specifications

Case	Void-free, transfer-molded, thermosetting plastic
Polarity	Cathode indicated by polarity band
Mounting Position	Any
Finish	All external surfaces are corrosion resistant and leads are readily solderable
Leads	Modified L-Bend providing more contact area to bond pads

Disclaimer Notice - Information furnished is believed to be accurate and reliable. However, users should independently evaluate the suitability of and test each product selected for their own applications. Littelfuse products are not designed for, and may not be used in, all applications. Read complete Disclaimer Notice at: www.littelfuse.com/disclaimer-electronics.

Looking for pricing, stock, or lifecycle information?

Click below to explore more details on WIN SOURCE:

-  [View 1SMB10CAT3G](#) on WIN SOURCE
-  [ON Semiconductor](#) Information

Optimize Your Supply Chain with WIN SOURCE Solutions

-  Global Sourcing Solution
-  Obsolete Management
-  Cost Control Management
-  Shortage Management
-  Alternative Solution
-  Excess Inventory Management