



**THE DATASHEET OF
ZED-F9R-03B**





ZED-F9R-03B

u-blox F9 high precision sensor fusion GNSS receiver
Professional grade

Data sheet

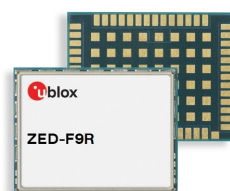

Abstract

This data sheet describes the ZED-F9R high precision sensor fusion module with 3D sensors and a multi-band GNSS receiver. It provides a reliable multi-band RTK turnkey solution with up to 30 Hz real-time position update rate and full GNSS carrier raw data.

www.u-blox.com

UBX-22024085 - R04
C1-Public



Document information

Title	ZED-F9R-03B	
Subtitle	u-blox F9 high precision sensor fusion GNSS receiver	
Document type	Data sheet	
Document number	UBX-22024085	
Revision and date	R04	03-May-2024
Disclosure restriction	C1-Public	

Product status	Corresponding content status	
Functional Sample	Draft	For functional testing. Revised and supplementary data will be published later.
In development / prototype	Objective specification	Target values. Revised and supplementary data will be published later.
Engineering sample	Advance information	Data based on early testing. Revised and supplementary data will be published later.
Initial production	Early production information	Data from product verification. Revised and supplementary data may be published later.
Mass production / End of life	Production information	Document contains the final product specification.

This document applies to the following products:

Product name	Type number	Firmware version	PCN reference	Product status
ZED-F9R	ZED-F9R-03B-00	HPS 1.30	-	Mass production

u-blox or third parties may hold intellectual property rights in the products, names, logos and designs included in this document. Copying, reproduction, or modification of this document or any part thereof is only permitted with the express written permission of u-blox. Disclosure to third parties is permitted for clearly public documents only.

The information contained herein is provided "as is" and u-blox assumes no liability for its use. No warranty, either express or implied, is given, including but not limited to, with respect to the accuracy, correctness, reliability and fitness for a particular purpose of the information. This document may be revised by u-blox at any time without notice. For the most recent documents, visit www.u-blox.com.

Copyright © 2024, u-blox AG.

Contents

1 Functional description.....	4
1.1 Overview.....	4
1.2 Performance.....	4
1.3 Supported GNSS constellations.....	6
1.4 Supported GNSS augmentation systems.....	6
1.4.1 Quasi-Zenith Satellite System (QZSS).....	6
1.4.2 Satellite-based augmentation system (SBAS).....	7
1.4.3 Differential GNSS (DGNSS).....	7
1.4.4 Centimeter level augmentation service (CLAS).....	8
1.5 Broadcast navigation data and satellite signal measurements.....	8
1.5.1 Carrier-phase measurements.....	8
1.6 Supported protocols.....	8
1.7 Firmware features.....	8
1.8 High precision sensor fusion (HPS).....	9
2 System description.....	10
2.1 Block diagram.....	10
3 Pin definition.....	11
3.1 Pin assignment.....	11
4 Electrical specifications.....	14
4.1 Absolute maximum ratings.....	14
4.2 Operating conditions.....	14
4.3 Indicative power requirements.....	15
5 Communications interfaces.....	16
5.1 UART.....	16
5.2 SPI.....	16
5.3 I2C.....	18
5.4 USB.....	19
5.5 WT (wheel tick) and DIR (forward/reverse indication).....	19
5.6 Default interface settings.....	20
6 Mechanical specifications.....	21
7 Qualifications and approvals.....	23
8 Labeling and ordering information.....	24
8.1 Product labeling.....	24
8.2 Explanation of product codes.....	24
8.3 Ordering codes.....	25
Related documents.....	26
Revision history.....	27

1 Functional description

1.1 Overview

The ZED-F9R-03B module with the u-blox F9 multi-band GNSS receiver features rapid convergence time within seconds. This mass-market component combines high precision positioning with highest availability, while making use of all four GNSS constellations simultaneously. It is the first sensor fusion module with an integrated inertial measurement unit (IMU) capable of high precision positioning. The sophisticated built-in algorithms fuse the IMU data, GNSS measurements, wheel ticks, and a dedicated dynamic model to provide accurate positioning where GNSS alone would fail.

The module operates under open sky, sidewalks, roads, in the wooded countryside, in difficult multi-path environments, and even in tunnels and underground parking. For modern autonomous robotic applications such as unmanned ground vehicles where control and availability are the keys to success, ZED-F9R-03B is the ultimate solution.

The device is a turnkey solution eliminating the technical risk of integrating third-party libraries, precise positioning engines, and the multi-faceted hardware engineering aspects of radio frequency design and digital design. The u-blox approach provides a transparent evaluation of the positioning solution and clear lines of responsibility for design support while reducing supply chain complexity during production.

ZED-F9R-03B offers support for a range of correction services allowing each application to optimize performance according to the application's unique needs. ZED-F9R-03B comes with built-in support for RTCM-formatted corrections, enabling high precision navigation using internet or satellite data connectivity. From firmware version HPS 1.21 onwards, the product supports SSR-type correction services suitable for mass-market deployment. Finally, the full set of RAW data from IMU sensors and GNSS carriers are provided.

ZED-F9R-03B modules use GNSS chips qualified according to AEC-Q100 and are manufactured in ISO/TS 16949 certified sites. Qualification tests are performed as stipulated in the ISO16750 standard. The professional-grade ZED-F9R-03B module adheres to industrial standard quality specifications and production flow.

1.2 Performance

Parameter	Specification	
Receiver type	Multi-band GNSS high precision sensor fusion receiver	
Accuracy of time pulse signal	RMS	30 ns
	99%	60 ns
Frequency of time pulse signal	0.25 Hz to 10 MHz (configurable)	
Operational limits ¹	Dynamics	≤ 4 g
	Altitude	80,000 m
	Velocity	500 m/s
Position error during GNSS loss ²	2%	

¹ Assuming airborne 4 g platform

² 68% error incurred without GNSS as a percentage of distance of traveled 3000 m, applicable to four-wheel road vehicle

Parameter	Specification	
Max navigation update rate (RTK) ³	Priority navigation mode	30 Hz
	Non-priority navigation mode	4 Hz
	Secondary output	4 Hz
Navigation latency	Priority navigation mode	15 ms
Velocity accuracy ⁴		0.05 m/s
Dynamic attitude accuracy ⁴	Heading	0.2 deg
	Pitch	0.3 deg
	Roll	0.5 deg
Max sensor measurement output rate		100 Hz

GNSS		GPS+GLO+GAL+BDS	GPS+GLO+GAL	GPS+GAL	GPS+GLO	BDS+GLO
Acquisition ⁵	Cold start	25 s	25 s	30 s	25 s	28 s
	Hot start	2 s	2 s	2 s	2 s	2 s
	Aided starts ⁶	3 s	3 s	3 s	3 s	4 s
Re-convergence time ^{7 8}	RTK	≤ 10 s	≤ 10 s	≤ 10 s	≤ 10 s	≤ 30 s
Sensitivity ^{9 10}	Tracking and nav.	-160 dBm	-160 dBm	-160 dBm	-160 dBm	-160 dBm
	Reacquisition	-159 dBm	-159 dBm	-158 dBm	-158 dBm	-158 dBm
	Cold start	-147 dBm	-147 dBm	-147 dBm	-147 dBm	-147 dBm
	Hot start	-158 dBm	-158 dBm	-158 dBm	-158 dBm	-158 dBm

Table 1: ZED-F9R-03B performance in different GNSS modes

GNSS		GPS+GLO+GAL+BDS	GPS+GLO+GAL	GPS+GAL	GPS+GLO	GPS+BDS	GPS
Horizontal position accuracy (CEP)	PVT ¹¹	1.5 m	1.5 m	1.5 m	1.5 m	1.5 m	1.5 m
	SBAS ¹¹	1.0 m	1.0 m	1.0 m	1.0 m	1.0 m	1.0 m
	RTK ¹²	0.01 m + 1 ppm	0.01 m + 1 ppm	0.01 m + 1 ppm	0.01 m + 1 ppm	0.01 m + 1 ppm	0.01 m + 1 ppm
Vertical position accuracy (Median)	RTK ¹²	0.01 m	0.01 m	0.01 m	0.01 m	0.01 m	0.01 m
		+ 1 ppm	+ 1 ppm	+ 1 ppm	+ 1 ppm	+ 1 ppm	+ 1 ppm

Table 2: ZED-F9R-03B position accuracy in different GNSS modes

³ Rates with QZSS enabled for > 98% fix report rate under typical conditions

⁴ 68% at 30 m/s for dynamic operation

⁵ All satellites at -130 dBm

⁶ Dependent on the speed and latency of the aiding data connection, commanded starts

⁷ 68% depending on atmospheric conditions, baseline length, GNSS antenna, multipath conditions, satellite visibility and geometry

⁸ Time to ambiguity fix after 20 s outage

⁹ Demonstrated with a good external LNA

¹⁰ Configured minCNO of 6 dBHz, limited by FW with minCNO of 20 dBHz for best performance

¹¹ 24 hours static

¹² Measured using 1 km baseline and patch antennas with good ground planes. Does not account for possible antenna phase center offset errors. ppm limited to baselines up to 20 km.

GNSS ¹³		GPS+GLO+GAL+BDS	GPS+GLO+GAL
Horizontal position accuracy (CEP)	SPARTN	< 0.06 m	< 0.06 m
	CLAS	0.04 m	0.04 m
Vertical position accuracy (Median)	SPARTN	< 0.12 m	< 0.12 m
	CLAS	0.08 m	0.08 m
Convergence time ⁷	SPARTN ¹⁴	< 45 s	< 45 s
	CLAS	< 70 s	< 70 s

Table 3: ZED-F9R-03B performance for PPP-RTK in different GNSS modes



PPP-RTK performance with SPARTN 2.0.1 protocol varies amongst service providers and service definitions. Performance has been validated with SPARTN correction stream available at the time of firmware release in April 2022.

1.3 Supported GNSS constellations

The ZED-F9R-03B GNSS modules are concurrent GNSS receivers that can receive and track multiple GNSS constellations. Owing to the multi-band RF front-end architecture, all four major GNSS constellations (GPS, GLONASS, Galileo and BeiDou) plus SBAS and QZSS satellites can be received concurrently. All satellites in view can be processed to provide an RTK navigation solution when used with correction data. If power consumption is a key factor, the receiver can be configured for a subset of GNSS constellations.

All satellites in view can be processed to provide an RTK navigation solution when used with correction data; the highest positioning accuracy will be achieved when the receiver is tracking signals on both bands from multiple satellites, and is provided with corresponding correction data.

The QZSS system shares the same frequency bands with GPS and can only be processed in conjunction with GPS.

To benefit from multi-band signal reception, dedicated hardware preparation must be made during the design-in phase. See the Integration manual [1] for u-blox design recommendations.

The ZED-F9R-03B supports the GNSS and their signals as shown in Table 4.

GPS / QZSS	GLONASS	Galileo	BeiDou	NavIC
L1C/A (1575.420 MHz)	L1OF (1602 MHz + $k \cdot 562.5$ kHz, $k = -7, \dots, 6$)	E1-B/C (1575.420 MHz)	B1I (1561.098 MHz)	-
L2C (1227.600 MHz)	L2OF (1246 MHz + $k \cdot 437.5$ kHz, $k = -7, \dots, 6$)	E5b (1207.140 MHz)	B2I (1207.140 MHz)	-

Table 4: Supported GNSS signals on ZED-F9R-03B

The ZED-F9R-03B can use the u-blox AssistNow™ Online service which provides GNSS assistance information.

1.4 Supported GNSS augmentation systems

1.4.1 Quasi-Zenith Satellite System (QZSS)

The Quasi-Zenith Satellite System (QZSS) is a regional navigation satellite system that provides positioning services for the Pacific region covering Japan and Australia. The ZED-F9R-03B is able

¹³ GPS used in combination with QZSS and SBAS

¹⁴ Measured for IP data stream only with low-latency communication link

to receive and track QZSS L1 C/A and L2C signals concurrently with GPS signals, resulting in better availability especially under challenging signal conditions, e.g. in urban canyons.

 QZSS can be enabled only if GPS operation is also configured.

1.4.2 Satellite-based augmentation system (SBAS)

The ZED-F9R-03B optionally supports SBAS (including WAAS in the US, EGNOS in Europe, MSAS in Japan and GAGAN in India) to deliver improved location accuracy within the regions covered. However, the additional inter-standard time calibration step used during SBAS reception results in degraded time accuracy overall.

 SBAS reception is disabled by default in ZED-F9R-03B.

1.4.3 Differential GNSS (DGNSS)

When operating in RTK mode, RTCM version 3.3 messages are required and the module supports DGNSS according to RTCM 10403.3. ZED-F9R-03B can decode the following RTCM 3.3 messages:

Message type	Description
RTCM 1001	L1-only GPS RTK observables
RTCM 1002	Extended L1-only GPS RTK observables
RTCM 1003	L1/L2 GPS RTK observables
RTCM 1004	Extended L1/L2 GPS RTK observables
RTCM 1005	Stationary RTK reference station ARP
RTCM 1006	Stationary RTK reference station ARP with antenna height
RTCM 1007	Antenna descriptor
RTCM 1009	L1-only GLONASS RTK observables
RTCM 1010	Extended L1-only GLONASS RTK observables
RTCM 1011	L1/L2 GLONASS RTK observables
RTCM 1012	Extended L1/L2 GLONASS RTK observables
RTCM 1033	Receiver and antenna description
RTCM 1074	GPS MSM4
RTCM 1075	GPS MSM5
RTCM 1077	GPS MSM7
RTCM 1084	GLONASS MSM4
RTCM 1085	GLONASS MSM5
RTCM 1087	GLONASS MSM7
RTCM 1094	Galileo MSM4
RTCM 1095	Galileo MSM5
RTCM 1097	Galileo MSM7
RTCM 1124	BeiDou MSM4
RTCM 1125	BeiDou MSM5
RTCM 1127	BeiDou MSM7
RTCM 1230	GLONASS code-phase biases

Table 5: Supported input RTCM 3.3 messages

Message type-subtype	Description
SM 0-0	GPS orbit, clock, bias (OCB)
SM 0-1	GLONASS orbit, clock, bias (OCB)

Message type-subtype	Description
SM 0-2	Galileo orbit, clock, bias (OCB)
SM 1-0	GPS high-precision atmosphere correction (HPAC)
SM 1-1	GLONASS high-precision atmosphere correction (HPAC)
SM 1-2	Galileo high-precision atmosphere correction (HPAC)
SM 2-0	Geographic area definition (GAD)

Table 6: Supported input SPARTN version 2.0.1 messages

1.4.4 Centimeter level augmentation service (CLAS)

A ZED-F9R-03B can receive UBX-RXM-QZSSL6 message from a NEO-D9C on any communication interface. The message contains QZSS CLAS (centimeter-level augmentation service) corrections. The CLAS protocol provides corrections for in-view GPS, Galileo, and QZSS satellites in Japan.

1.5 Broadcast navigation data and satellite signal measurements

The ZED-F9R-03B can output all the GNSS broadcast data upon reception from tracked satellites. This includes all the supported GNSS signals as well as the QZSS and SBAS augmentation services. The UBX-RXM-SFRBX message provides this information, see the Interface description [2] for the UBX-RXM-SFRBX message specification. The receiver can provide satellite signal information in a form compatible with the Radio Resource LCS Protocol (RRLP) [4].

1.5.1 Carrier-phase measurements

The ZED-F9R-03B modules provide raw carrier-phase data for all supported signals, along with pseudorange, Doppler and measurement quality information. The data contained in the UBX-RXM-RAWX message follows the conventions of a multi-GNSS RINEX 3 observation file. For the UBX-RXM-RAWX message specification, see Interface description [2].



Raw measurement data are available once the receiver has established data bit synchronization and time-of-week.

1.6 Supported protocols

The ZED-F9R-03B supports the following protocols:

Protocol	Type
UBX	Input/output, binary, u-blox proprietary
NMEA 4.11 (default), 4.10, 4.0, 2.3, and 2.1	Input/output, ASCII
SPARTN 2.0.1	Input, binary
RTCM 3.3	Input, binary

Table 7: Supported protocols

For specification of the protocols, see the Interface description [2].

1.7 Firmware features

Feature	Description
Advanced calibration handling	Calibration information can be stored with the host
Automotive dead reckoning	Combines satellite and sensor-based navigation (IMU and odometer input)
Automatic alignment	Automatic estimation of the alignment angles (automotive dynamic model only)
Backup modes	Hardware backup mode, software backup mode

Feature	Description
Dual output	GNSS only and Fused (GNSS+DR) output
Geofencing	Up to 4 circular areas; GPIO for waking up external CPU
Protection level	Computed by the receiver in real-time, quantifies the reliability of the position information
Upgradeable firmware	Firmware in flash memory can be upgraded
Wake on motion	Wakes up the host while the receiver is in SW backup mode

Table 8: Firmware features

1.8 High precision sensor fusion (HPS)

u-blox's proprietary high precision sensor fusion (HPS) solution uses a 3D inertial measurement unit (IMU) included within the module and speed pulses from the wheel sensors. Alternatively, the velocity data can be provided via software interface. Sensor data and GNSS signals are processed together, achieving 100% coverage, with highly accurate and continuous positioning even in GNSS-hostile environments (e.g. urban areas) or in case of GNSS signal absence (e.g. tunnels, multi-level parking structures).

Wheel or speed sensor rate variations and the 3D IMU sensors are calibrated automatically and continuously by the module, accommodating, for example, if wheel diameter changes.

 For more details, see the ZED-F9R-03B Integration manual [1].

The ZED-F9R-03B combines GNSS and sensor measurements and computes a position solution at rates of up to 4 Hz with non-priority navigation mode. In priority navigation mode the navigation rate can be increased using IMU-only data to deliver accurate, low-latency position measurements at rates up to 30 Hz. These solutions are reported in standard NMEA, UBX-NAV-PVT and similar messages.

 The priority navigation mode works optimally when the IMU and WT sensors have been calibrated, and the alignment angles are correct.

The dead reckoning mode allows navigation to commence as soon as power is applied to the module (i.e. before a GNSS fix has been established) under the following conditions:

- the vehicle has not been moved while the module is switched off
- at least a dead reckoning (DR) fix was available when the vehicle was last used
- a backup supply has been available for the module since the vehicle was last used

 The save-on-shutdown feature can be used when no backup supply is available. All necessary information is saved to the flash and read from the flash upon restart.

ZED-F9R-03B's high precision sensor fusion algorithm is optimized for the following platforms.

- Automotive
- E-scooter
- Robotic lawn mower

 For more information regarding the supported HPS dynamic models, see the ZED-F9R-03B Integration manual [1].

2 System description

2.1 Block diagram

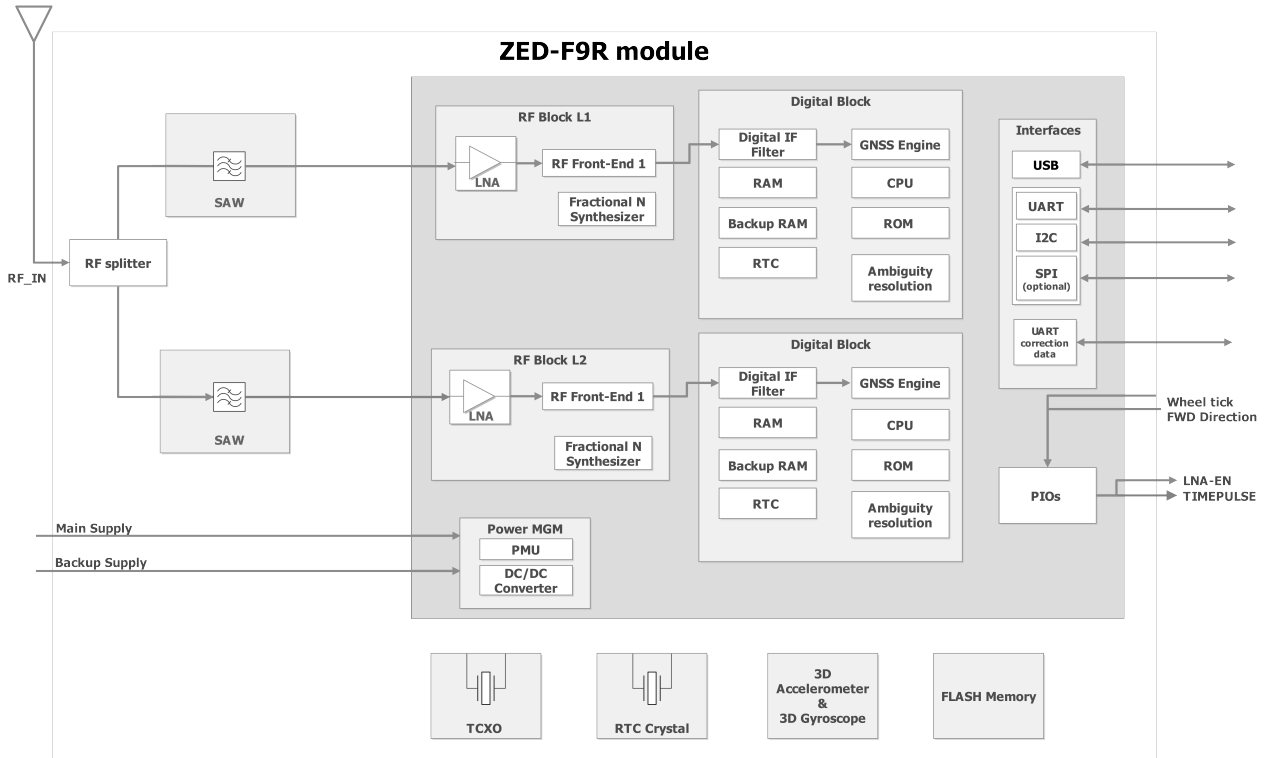

Figure 1: ZED-F9R-03B block diagram

3 Pin definition

3.1 Pin assignment

The pin assignment of the ZED-F9R-03B module is shown in [Figure 2](#). The defined configuration of the PIOs is listed in [Table 9](#).



The ZED-F9R-03B is an LGA package with the I/O on the outside edge and central ground pads.

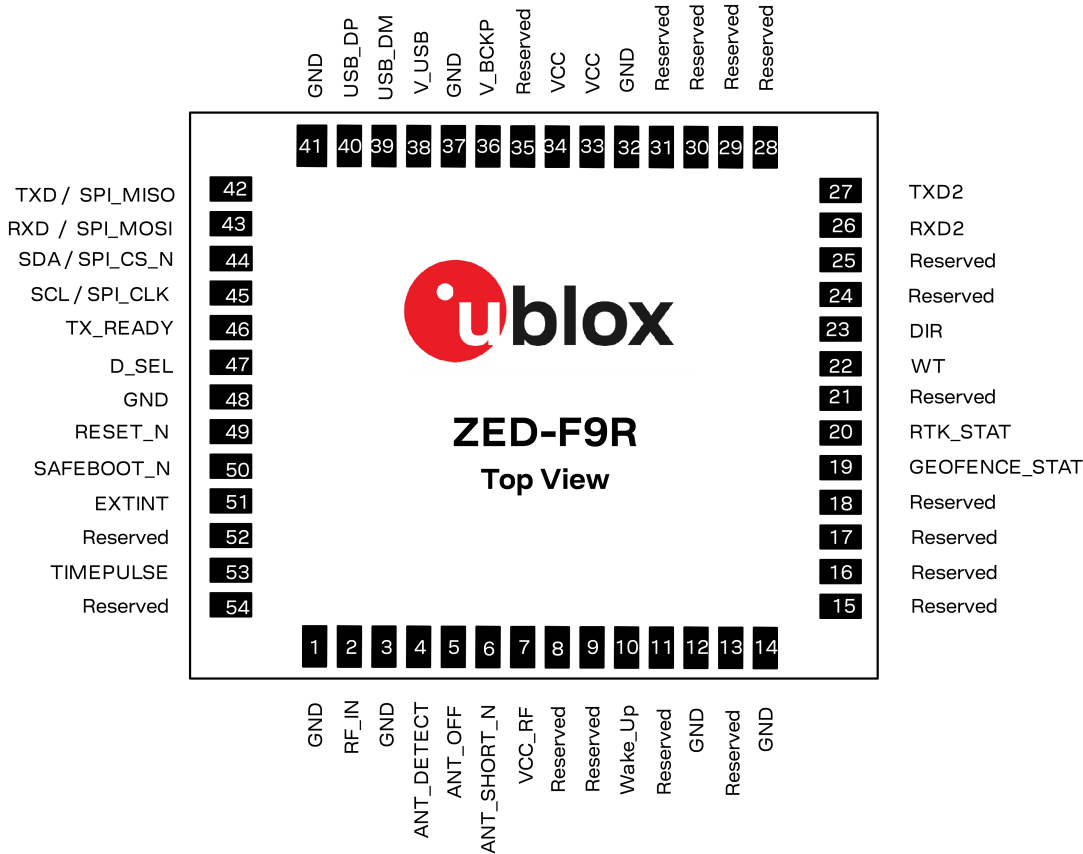

Figure 2: ZED-F9R-03B pin assignment

Pin no.	Name	I/O	Description
1	GND	-	Ground
2	RF_IN	I	RF input
3	GND	-	Ground
4	ANT_DETECT	I	Active antenna detect
5	ANT_OFF	O	External LNA disable
6	ANT_SHORT_N	I	Active antenna short detect
7	VCC_RF	O	Voltage for external LNA
8	Reserved	-	Reserved
9	Reserved	-	Reserved
10	Wake_Up	O	Wake on motion
11	Reserved	-	Reserved

Pin no.	Name	I/O	Description
12	GND	-	Ground
13	Reserved	-	Reserved
14	GND	-	Ground
15	Reserved	-	Reserved
16	Reserved	-	Reserved
17	Reserved	-	Reserved
18	Reserved	-	Reserved
19	GEOFENCE_STAT	O	Geofence status, user defined
20	RTK_STAT	O	RTK status 0 – fixed, blinking – receiving and using corrections, 1 – no corrections
21	Reserved	-	Reserved
22	WT	I	Wheel ticks
23	DIR	I	Direction
24	Reserved	-	Reserved
25	Reserved	-	Reserved
26	RXD2	I	Correction UART input
27	TXD2	O	Correction UART output
28	Reserved	-	Reserved
29	Reserved	-	Reserved
30	Reserved	-	Reserved
31	Reserved	-	Reserved
32	GND	-	Ground
33	VCC	I	Voltage supply
34	VCC	I	Voltage supply
35	Reserved	-	Reserved
36	V_BCKP	I	Backup supply voltage
37	GND	-	Ground
38	V_USB	I	USB power input
39	USB_DM	I/O	USB data
40	USB_DP	I/O	USB data
41	GND	-	Ground
42	TXD / SPI_SDO	O	Serial port if D_SEL = 1 (or open). SPI SDO if D_SEL = 0
43	RXD / SPI_SDI	I	Serial port if D_SEL = 1 (or open). SPI SDI if D_SEL = 0
44	SDA / SPI_CS_N	I/O	I2C data if D_SEL = 1 (or open). SPI chip select if D_SEL = 0
45	SCL / SPI_CLK	I/O	I2C Clock if D_SEL = 1 (or open). SPI clock if D_SEL = 0
46	TX_READY	O	TX_Buffer full and ready for TX of data
47	D_SEL	I	Interface select
48	GND	-	Ground
49	RESET_N	I	RESET_N
50	SAFEBOOT_N	I	SAFEBOOT_N (for future service, updates and reconfiguration, leave OPEN)
51	EXT_INT	I	External interrupt pin
52	Reserved	-	Reserved
53	TIMEPULSE	O	Time pulse

Pin no.	Name	I/O	Description
54	Reserved	-	Reserved

Table 9: ZED-F9R-03B pin assignment

4 Electrical specifications

4.1 Absolute maximum ratings

- CAUTION. Risk of device damage. Exceeding the absolute maximum ratings may affect the lifetime and reliability of the device or permanently damage it. Do not exceed the absolute maximum ratings.
- This product is not protected against overvoltage or reversed voltages. Use appropriate protection to avoid device damage from voltage spikes exceeding the specified boundaries.

Parameter	Symbol	Condition	Min	Max	Units
Power supply voltage	VCC		-0.5	3.6	V
Voltage ramp on VCC ¹⁵			20	8000	µs/V
Backup battery voltage	V_BCKP		-0.5	3.6	V
Voltage ramp on V_BCKP ¹⁵			20		µs/V
Input pin voltage	V _{in}	VCC ≤ 3.1 V	-0.5	VCC + 0.5	V
		VCC > 3.1 V	-0.5	3.6	V
VCC_RF output current	ICC_RF			300	mA
Supply voltage USB	V_USB		-0.5	3.6	V
USB signals	USB_DM, USB_DP		-0.5	V_USB + 0.5	V
Input power at RF_IN	Pr _{fin}	source impedance = 50 Ω, continuous wave		10	dBm
Storage temperature	T _{stg}		-40	+85	°C

Table 10: Absolute maximum ratings

4.2 Operating conditions

- Extreme operating temperatures can significantly impact the specified values. If an application operates near the min or max temperature limits, ensure the specified values are not exceeded.

Parameter	Symbol	Min	Typical	Max	Units	Condition
Power supply voltage	VCC	2.7	3.0	3.6	V	
Backup battery voltage	V_BCKP	1.65		3.6	V	
Backup battery current ^{16, 17}	I_BCKP		45		µA	V_BCKP = 3 V, VCC = 0 V
SW backup current ¹⁷	I_SWBCKP		1.5		mA	
Input pin voltage range	V _{in}	0		VCC	V	
Digital IO pin low level input voltage	V _{il}			0.4	V	
Digital IO pin high level input voltage	V _{ih}	0.8 * VCC			V	
Digital IO pin low level output voltage	V _{ol}			0.4	V	I _{ol} = 2 mA ¹⁸
Digital IO pin high level output voltage	V _{oh}	VCC - 0.4			V	I _{oh} = 2 mA ¹⁸

¹⁵ Exceeding the ramp speed may permanently damage the device

¹⁶ To measure the I_BCKP the receiver should first be switched on, i.e. VCC and V_BCKP is available. Then set VCC to 0 V while the V_BCKP remains available. Afterward measure the current consumption at the V_BCKP.

¹⁷ The value has been characterized at 25 °C ambient temperature.

¹⁸ TIMEPULSE has 4 mA current drive/sink capability

Parameter	Symbol	Min	Typical	Max	Units	Condition
DC current through any digital I/O pin (except supplies)	I_{pin}			5	mA	
Pull-up resistance for SCL, SDA	R_{pu}	7	15	30	k Ω	
Pull-up resistance for D_SEL, RXD, TXD, SAFEBOOT_N, EXTINT	R_{pu}	30	75	130	k Ω	
Pull-up resistance for RESET_N	R_{pu}	7	10	13	k Ω	
VCC_RF voltage	VCC_RF		VCC - 0.1		V	
VCC_RF output current	ICC_RF			50	mA	
Receiver chain noise figure ¹⁹	NFtot		9.5		dB	
External gain (at RF_IN)	Ext_gain	17		50	dB	
Operating temperature	Topr	-40	+25	+85	°C	

Table 11: Operating conditions

4.3 Indicative power requirements

Table 12 provides examples of typical current requirements when using a cold start command. The given values are total system supply current for a possible application including RF and baseband sections.

All values in Table 12 have been measured at 25 °C ambient temperature.



The actual power requirements vary depending on the FW version used, external circuitry, number of satellites tracked, signal strength, type and time of start, duration, and conditions of test.

Symbol	Parameter	Conditions	GPS+GLO +GAL+BDS	GPS	Unit
I_{PEAK}	Peak current	Acquisition	130	120	mA
I_{VCC}^{20}	VCC current	Acquisition	90	75	mA
I_{VCC}^{20}	VCC current	Tracking	85	70	mA

Table 12: Currents to calculate the indicative power requirements

¹⁹ Only valid for GPS

²⁰ Simulated GNSS signal

5 Communications interfaces

The ZED-F9R-03B has several communications interfaces²¹, including UART, SPI, I2C and USB.

All the inputs have internal pull-up resistors in normal operation and can be left open if not used. All the PIOs are supplied by VCC, therefore all the voltage levels of the PIO pins are related to VCC supply voltage.

5.1 UART

The UART interfaces support configurable baud rates. See the Integration manual [1].

Hardware flow control is not supported.

UART1 is the primary host communications interface while UART2 is dedicated for DCS-correction interface, RTCM 3.3 corrections and NMEA. UBX protocol is supported on UART2 but disabled by default.

The UART1 is enabled if D_SEL pin of the module is left open or "high".

Symbol	Parameter	Min	Max	Unit
R_u	Baud rate	9600	921600	bit/s
Δ_{Tx}	Tx baud rate accuracy	-1%	+1%	-
Δ_{Rx}	Rx baud rate tolerance	-2.5%	+2.5%	-

Table 13: ZED-F9R-03B UART specifications

5.2 SPI

The SPI interface is disabled by default. The SPI interface shares pins with UART and I2C and can be selected by setting D_SEL = 0. The SPI interface can be operated in peripheral mode only. The maximum transfer rate using SPI is 125 kB/s and the maximum SPI clock frequency is 5.5 MHz.

The SPI timing parameters for peripheral operation are defined in [Figure 3](#). Default SPI configuration is CPOL = 0 and CPHA = 0.

²¹ The signal names and related terms have been replaced with new terminology in this document.

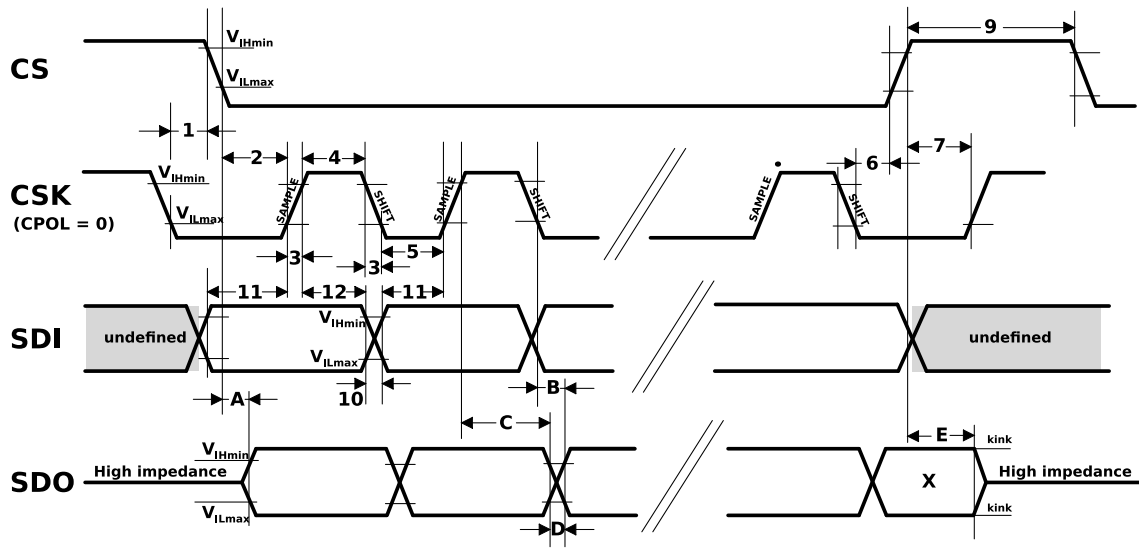

Figure 3: ZED-F9R-03B SPI specification mode 1: CPHA=0 SCK = 5.33 MHz

Symbol	Parameter	Min	Max	Unit
1	CS deassertion hold time	23	-	ns
2	Chip select time (CS to SCK)	20	-	ns
3	SCK rise/fall time	-	7	ns
4	SCK high time	24	-	ns
5	SCK low time	24	-	ns
6	Chip deselect time (SCK falling to CS)	30	-	ns
7	Chip deselect time (CS to SCK)	30	-	ns
9	CS high time	32	-	ns
10	SDI transition time	-	7	ns
11	SDI setup time	16	-	ns
12	SDI hold time	24	-	ns

Table 14: SPI peripheral input timing parameters 1 - 12

Symbol	Parameter	Min	Max	Unit
A	SDO data valid time (CS)	12	40	ns
B	SDO data valid time (SCK), weak driver mode	15	40	ns
C	SDO data hold time	100	140	ns
D	SDO rise/fall time, weak driver mode	0	5	ns
E	SDO data disable lag time	15	35	ns

Table 15: SPI peripheral timing parameters A - E, 2 pF load capacitance

Symbol	Parameter	Min	Max	Unit
A	SDO data valid time (CS)	16	55	ns
B	SDO data valid time (SCK), weak driver mode	20	55	ns
C	SDO data hold time	100	150	ns
D	SDO rise/fall time, weak driver mode	3	20	ns

Symbol	Parameter	Min	Max	Unit
E	SDO data disable lag time	15	35	ns

Table 16: SPI peripheral timing parameters A - E, 20 pF load capacitance

Symbol	Parameter	Min	Max	Unit
A	SDO data valid time (CS)	26	85	ns
B	SDO data valid time (SCK), weak driver mode	30	85	ns
C	SDO data hold time	110	160	ns
D	SDO rise/fall time, weak driver mode	13	45	ns
E	SDO data disable lag time	15	35	ns

Table 17: SPI peripheral timing parameters A - E, 60 pF load capacitance

5.3 I2C

An I2C interface is available for communication with an external host CPU in I2C Fast-mode. Backwards compatibility with Standard-mode I2C bus operation is not supported. The interface can be operated only in peripheral mode with a maximum bit rate of 400 kbit/s. The interface can make use of clock stretching by holding the SCL line LOW to pause a transaction. In this case, the bit transfer rate is reduced. The maximum clock stretching time is 20 ms.

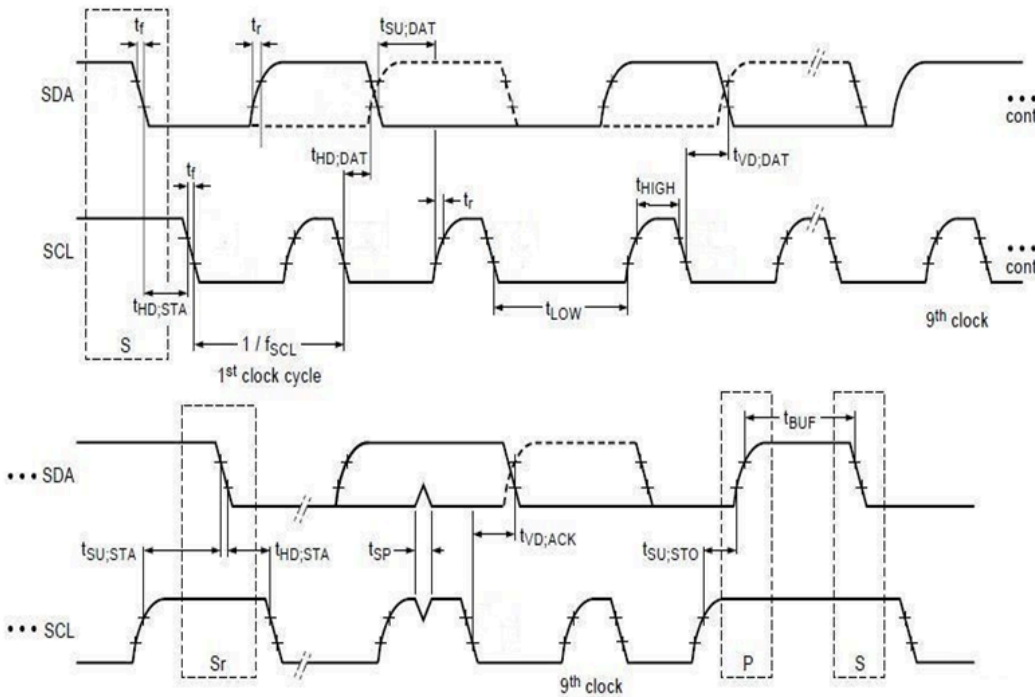
Figure 4: ZED-F9R-03B I2C peripheral specification

Symbol	Parameter	I2C Fast-mode		Unit
		Min	Max	
f_{SCL}	SCL clock frequency	0	400	kHz
$t_{HD;STA}$	Hold time (repeated) START condition	0.6	-	μ s
t_{LOW}	Low period of the SCL clock	1.3	-	μ s
t_{HIGH}	High period of the SCL clock	0.6	-	μ s
$t_{SU;STA}$	Setup time for a repeated START condition	0.6	-	μ s

Symbol	Parameter	I2C Fast-mode		Unit
		Min	Max	
$t_{HD;DAT}$	Data hold time	0 ²²	- ²³	μs
$t_{SU;DAT}$	Data setup time	100 ²⁴		ns
t_r	Rise time of both SDA and SCL signals	-	300 (for C = 400pF)	ns
t_f	Fall time of both SDA and SCL signals	-	300 (for C = 400pF)	ns
$t_{SU;STO}$	Setup time for STOP condition	0.6	-	μs
t_{BUF}	Bus-free time between a STOP and START condition	1.3	-	μs
$t_{VD;DAT}$	Data valid time	-	0.9 ²³	μs
$t_{VD;ACK}$	Data valid acknowledge time	-	0.9 ²³	μs
V_{nL}	Noise margin at the low level	0.1 VCC	-	V
V_{nH}	Noise margin at the high level	0.2 VCC	-	V

Table 18: ZED-F9R-03B I2C peripheral timings and specifications

The I2C interface is only available with the UART default mode. If the SPI interface is selected by using D_SEL = 0, the I2C interface is not available.

5.4 USB

The USB 2.0 FS (full speed, 12 Mbit/s) interface can be used for host communication. Due to the hardware implementation, it may not be possible to certify the USB interface. The V_USB pin supplies the USB interface.

5.5 WT (wheel tick) and DIR (forward/reverse indication)

ZED-F9R-03B pin 22 (WT) is available as a wheel-tick input. The pin 23 (DIR) is available as a direction input (forward/reverse indication).

By default the wheel tick count is derived from the rising edges of the WT input.

For optimal performance the wheel tick resolution should be less than 5 cm. With the maximum supported wheel tick resolution is 40 cm.

The DIR input shall indicate whether the vehicle is moving forwards or backwards.

Alternatively, the vehicle WT (or speed) and DIR inputs can be provided via one of the communication interfaces with UBX-ESF-MEAS messages.



For more details, see the integration manual [1].

²² External device must provide a hold time of at least one transition time (max 300 ns) for the SDA signal (with respect to the min V_{ih} of the SCL signal) to bridge the undefined region of the falling edge of SCL.

²³ The maximum $t_{HD;DAT}$ must be less than the maximum $t_{VD;DAT}$ or $t_{VD;ACK}$ with a maximum of 0.9 μs by a transition time. This maximum must only be met if the device does not stretch the LOW period (tLOW) of the SCL signal. If the clock stretches the SCL, the data must be valid by the set-up time before it releases the clock.

²⁴ When the I2C peripheral is stretching the clock, the $t_{SU;DAT}$ of the first bit of the next byte is 62.5 ns.

5.6 Default interface settings

Interface	Settings
UART1 output	38400 baud, 8 bits, no parity bit, 1 stop bit. NMEA protocol with GGA, GLL, GSA, GSV, RMC, VTG, TXT messages are output by default. UBX protocol is enabled by default but no output messages are enabled by default. RTCM 3.3 protocol output is not supported.
UART1 input	38400 baud, 8 bits, no parity bit, 1 stop bit. UBX, NMEA and RTCM 3.3 input protocols are enabled by default. SPARTN input protocol is enabled by default.
UART2 output	38400 baud, 8 bits, no parity bit, 1 stop bit. UBX protocol is disabled by default. It can be enabled as an output protocol from firmware version HPS 1.30 onwards. It cannot be enabled as an output protocol on any of the previous firmware versions and will not output UBX messages. RTCM 3.3 protocol output is not supported. NMEA protocol is disabled by default.
UART2 input	38400 baud, 8 bits, no parity bit, 1 stop bit. UBX protocol is disabled by default from firmware version HPS 1.30 onwards. It can be enabled as an input protocol on firmware version 1.30. It cannot be enabled as an input protocol on any of the previous firmware versions and will not receive UBX input messages. RTCM 3.3 protocol is enabled by default. SPARTN protocol is enabled by default. NMEA protocol is disabled by default.
USB	Default messages activated as in UART1. Input/output protocols available as in UART1.
I2C	Available for communication in the Fast-mode with an external host CPU in peripheral mode only. Default messages activated as in UART1. Input/output protocols available as in UART1. Maximum bit rate 400 kb/s.
SPI	Allow communication to a host CPU, operated in peripheral mode only. Default messages activated as in UART1. Input/output protocols available as in UART1. SPI is not available unless D_SEL pin is set to low (see section D_SEL interface in Integration manual [1]).

Table 19: Default interface settings

UART2 can be configured as an RTCM interface. RTCM 3.3 is the default input protocol. UART2 may also be configured for NMEA output. NMEA GGA output is typically used with virtual reference service correction services.



By default, the ZED-F9R-03B outputs NMEA messages that include satellite data for all GNSS bands being received. This results in a high NMEA output load for each navigation period. Make sure the UART baud rate used is sufficient for the selected navigation rate and the number of GNSS signals being received.



Do not use UART2 as the only one interface to the host. Not all UBX functionality is available on UART2, such as firmware upgrade, safeboot or backup modes functionalities. No start-up boot screen is sent out from UART2.

6 Mechanical specifications

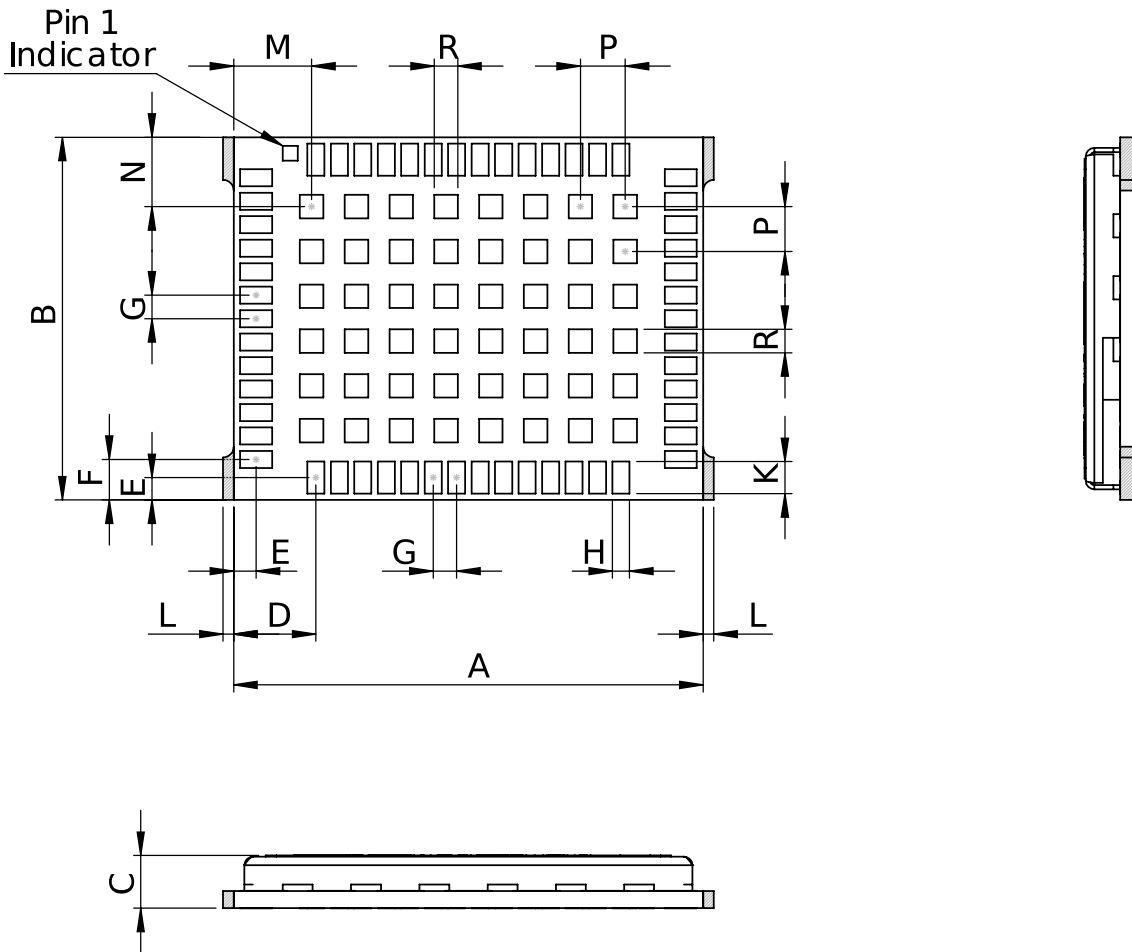

Figure 5: ZED-F9R-03B mechanical drawing

Symbol	Min (mm)	Typical (mm)	Max (mm)
A	21.80	22.00	22.20
B	16.80	17.00	17.20
C	2.20	2.40	2.60
D	3.65	3.85	4.05
E	0.85	1.05	1.25
F	1.70	1.90	2.10
G	1.05	1.10	1.15
H	0.70	0.80	0.96
K	1.20	1.50	1.80
M	3.45	3.65	3.85
N	3.05	3.25	3.45
P	2.05	2.10	2.15

Symbol	Min (mm)	Typical (mm)	Max (mm)
R	0.88	1.10	1.32
L	0.00		0.30
Weight		1.8 g	

Table 20: ZED-F9R-03B mechanical dimensions



The mechanical picture of the de-paneling residual tabs (L) is an approximate representation. The shape and position may vary.



Take the size of the de-paneling residual tabs into account when designing the component keep-out area.

7 Qualifications and approvals

Quality and reliability	
Product qualification	Qualified according to ISO 16750
Chip qualification	Modules are based on AEC-Q100 qualified GNSS chips
Manufacturing	Manufactured at ISO/TS 16949 certified sites
Environmental	
RoHS compliance	Yes
Moisture sensitivity level (MSL) ^{25 26}	4
Type approvals	
European RED certification (CE)	Declaration of Conformity (DoC) is available on the u-blox website .
UK conformity assessment (UKCA)	Yes

Table 21: Qualifications and approvals

²⁵ For the MSL standard, see IPC/JEDEC J-STD-020 and J-STD-033, available on www.jedec.org

²⁶ For more information regarding moisture sensitivity levels, labelling, storage and drying, see the Product packaging reference guide [3]

8 Labeling and ordering information

This section provides information about product labeling and ordering. For information about product handling and soldering see the Integration manual [1].

8.1 Product labeling

The labeling of the ZED-F9R-03B modules provides product information and revision information. For more information, contact u-blox sales.

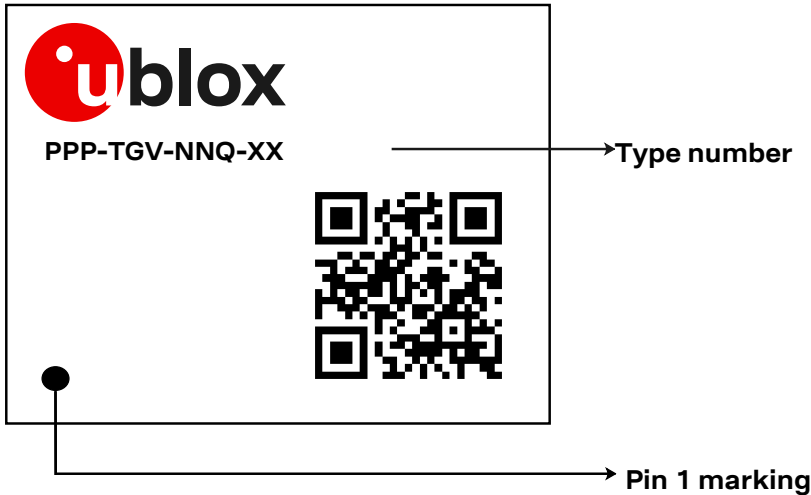

Figure 6: Example of ZED-F9R-03B label

8.2 Explanation of product codes

Three product code formats are used in the ZED-F9R-03B labels. The **Product name** used in documentation such as this data sheet identifies all u-blox products, independent of packaging and quality grade. The **Ordering code** includes options and quality, while the **Type number** includes the hardware and firmware versions.

Table 22 below details these three formats.

Format	Structure	Product code
Product name	PPP-TGV	ZED-F9R
Ordering code	PPP-TGV-NNQ	ZED-F9R-03B
Type number	PPP-TGV-NNQ-XX	ZED-F9R-03B-00

Table 22: Product code formats

The parts of the product code are explained in Table 23.

Code	Meaning	Example
PPP	Product family	ZED
TG	Platform	F9 = u-blox F9
V	Variant	R = High precision sensor fusion
NNQ	Option / Quality grade	NN: Option [00...99] Q: Grade, A = Automotive, B = Professional
XX	Product detail	Describes hardware and firmware versions

Table 23: Part identification code

8.3 Ordering codes

Ordering code	Product	Remark
ZED-F9R-03B	u-blox ZED-F9R-03B	Product shipped with firmware FW HPS 1.30

Table 24: Product ordering codes



Product changes affecting form, fit or function are documented by u-blox. For a list of Product Change Notifications (PCNs) see our website at: <https://www.u-blox.com/en/product-resources>.

Related documents

- [1] ZED-F9R Integration manual, [UBX-20039643](#)
- [2] HPS 1.30 Interface description, [UBX-22010984](#)
- [3] Product packaging reference guide [UBX-14001652](#)
- [4] Radio Resource LCS Protocol (RRLP), (3GPP TS 44.031 version 11.0.0 Release 11)



For regular updates to u-blox documentation and to receive product change notifications please register on our homepage <https://www.u-blox.com>.

Revision history

Revision	Date	Status / comments
R01	16-Sep-2022	Engineering sample - ZED-F9R-03B
R02	23-Mar-2023	Initial production - ZED-F9R-03B Updated I2C and SPI timing specifications in section Communications interfaces Updated VCC_RF output current in table Absolute maximum ratings Updated backup current in table Operating conditions Added timepulse details in table Operating conditions
R03	31-Oct-2023	Mass production - ZED-F9R-03B
R04	03-May-2024	Updated sections: <ul style="list-style-type: none">• Performance• Mechanical specifications updated with information on de-paneling residual tabs• Qualifications and approvals• Product labeling• Information on moisture sensitivity level has been moved from the Integration manual to chapter Qualifications and approvals• Editorial changes throughout the document

Contact

u-blox AG

Address: Zürcherstrasse 68
8800 Thalwil
Switzerland

For further support and contact information, visit us at www.u-blox.com/support.

Looking for pricing, stock, or lifecycle information?

Click below to explore more details on WIN SOURCE:

 [View ZED-F9R-03B on WIN SOURCE](#)

 [U-blox Information](#)

Optimize Your Supply Chain with WIN SOURCE Solutions

-  Global Sourcing Solution
-  Obsolete Management
-  Cost Control Management
-  Shortage Management
-  Alternative Solution
-  Excess Inventory Management