



**THE DATASHEET OF
UCLAMP0871P.TNT**



PROTECTION PRODUCTS

Description

μClamp® TVS diodes are designed to protect sensitive electronics from damage or latch-up due to EOS, lightning, CDE, and ESD. They feature large cross-sectional area junctions for conducting high transient currents. These devices offer desirable characteristics for board level protection including fast response time, low operating and clamping voltage, and no device degradation.

The μClamp®xx71P series are in 2-pin SGP1610N2 package measuring 1.6 x 1.0 mm with a nominal height of 0.57mm. The leads are finished with leadfree NiPdAu. They may be used to protect 5V, 8V, 10V, 12V, 15V, 18V, 22V, 26V, and 36V systems. They feature high surge current capability and low clamping voltage making them ideal for use in harsh transient environments.

Features

- Transient protection for high-speed data lines to
- IEC 61000-4-2 (ESD) 30kV (air), 30kV (contact)
- IEC 61000-4-4 (EFT) 40A (5/50ns)
- IEC 61000-4-5 (Lightning) 20 - 80A (8/20μs)
- Protects one data or power line
- Low leakage current
- High peak pulse current capability
- Operating voltage options: 5V, 8V, 10V, 12V, 15V, 18V, 22V, 26V, 36V
- Solid-state silicon-avalanche technology

Mechanical Characteristics

- SGP1610N2 package
- Pb-Free, Halogen Free, RoHS/WEEE Compliant
- Nominal Dimensions: 1.6 x 1.0 x 0.57 mm
- Lead Finish: NiPdAu
- Marking: Marking code
- Packaging: Tape and Reel

Applications

- Cellular Handsets & Accessories
- USB Voltage Bus
- Battery Protection
- Digital Lines
- Proximity Sensors

Package Dimension

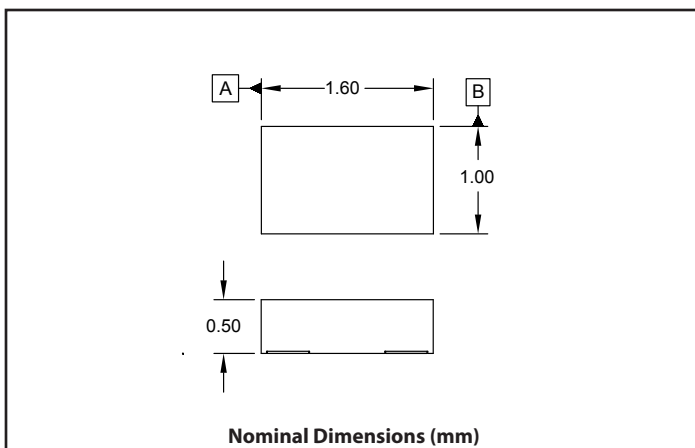

Schematic & Pin Configuration

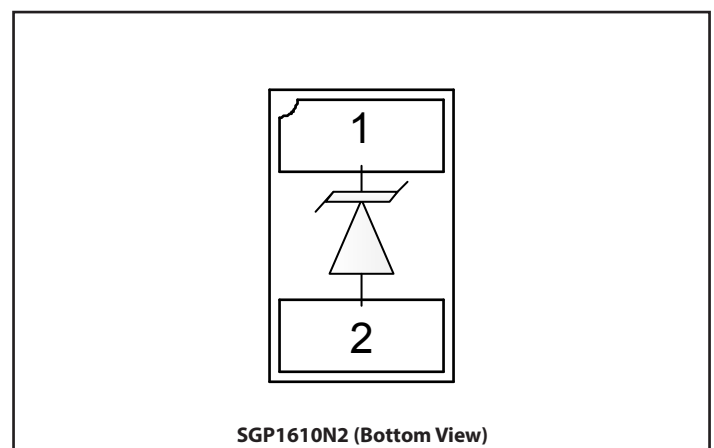

Absolute Maximum Rating

Rating	Symbol	Value	Units
Peak Pulse Power (tp = 8/20μs)	P _{PK}	1200-1500	W
ESD per IEC 61000-4-2 (Air) ¹ ESD per IEC 61000-4-2 (Contact) ¹	V _{ESD}	±30 ±30	kV
Operating Temperature	T _J	-40 to +125	°C
Storage Temperature	T _{STG}	-55 to +150	°C

Electrical Characteristics (T=25°C unless otherwise specified)

μClamp0571P						
Parameter	Symbol	Conditions	Min.	Typ.	Max.	Units
Reverse Stand-Off Voltage	V _{RWM}	Pin 1 to 2			5	V
Reverse Breakdown Voltage	V _{BR}	I _{BR} = 1mA, Pin 1 to 2	6	7	9	V
Reverse Leakage Current	I _R	V _{RWM} = 5V T = 25°C		<10	100	nA
Peak Pulse Current	I _{pp}	tp = 8/20μs, Pin 1 to 2			80	A
Clamping Voltage	V _C	tp = 8/20μs			10	V
					15	
Dynamic Resistance ^{2,3}	R _{DYN}	tp = 0.2/100ns		0.05		Ω
Junction Capacitance	C _J	V _R = 0V, f = 1MHz			675	pF

μClamp0871P						
Parameter	Symbol	Conditions	Min.	Typ.	Max.	Units
Reverse Stand-Off Voltage	V _{RWM}	Pin 1 to 2			8	V
Reverse Breakdown Voltage	V _{BR}	I _{BR} = 1mA, Pin 1 to 2	9.5	11	13	V
Reverse Leakage Current	I _R	V _{RWM} = 8V T = 25°C		<10	100	nA
Peak Pulse Current	I _{pp}	tp = 8/20μs, Pin 1 to 2			65	A
Clamping Voltage	V _C	tp = 8/20μs			15	V
					23	
Dynamic Resistance ^{2,3}	R _{DYN}	tp = 0.2/100ns		0.05		Ω
Junction Capacitance	C _J	V _R = 0V, f = 1MHz			475	pF

Electrical Characteristics (T=25°C unless otherwise specified)

μClamp1071P							
Parameter	Symbol	Conditions	Min.	Typ.	Max.	Units	
Reverse Stand-Off Voltage	V_{RWM}	Pin 1 to 2			10	V	
Reverse Breakdown Voltage	V_{BR}	$I_{BR} = 1\text{mA}$, Pin 1 to 2	12	13.5	15.5	V	
Reverse Leakage Current	I_R	$V_{RWM} = 10\text{V}$, Pin 1 to 2	T = 25°C		<10	100	nA
Peak Pulse Current	I_{PP}	tp = 8/20μs, Pin 1 to 2			60	A	
Clamping Voltage	V_C	tp = 8/20μs	$I_{PP} = 10\text{A}$		17	V	
			$I_{PP} = 60\text{A}$		25		
Dynamic Resistance ^{2,3}	R_{DYN}	tp = 0.2/100ns		0.05		Ω	
Junction Capacitance	C_J	$V_R = 0\text{V}$, f = 1MHz			350	pF	

μClamp1271P							
Parameter	Symbol	Conditions	Min.	Typ.	Max.	Units	
Reverse Stand-Off Voltage	V_{RWM}	Pin 1 to 2			12	V	
Reverse Breakdown Voltage	V_{BR}	$I_{BR} = 1\text{mA}$, Pin 1 to 2	14	16	19	V	
Reverse Leakage Current	I_R	$V_{RWM} = 12\text{V}$, Pin 1 to 2	T = 25°C		<10	100	nA
Peak Pulse Current	I_{PP}	tp = 8/20μs, Pin 1 to 2			45	A	
Clamping Voltage	V_C	tp = 8/20μs	$I_{PP} = 10\text{A}$		22	V	
			$I_{PP} = 45\text{A}$		30		
Dynamic Resistance ^{2,3}	R_{DYN}	tp = 0.2/100ns		0.05		Ω	
Junction Capacitance	C_J	$V_R = 0\text{V}$, f = 1MHz			275	pF	

μClamp1571P						
Parameter	Symbol	Conditions	Min.	Typ.	Max.	Units
Reverse Stand-Off Voltage	V_{RWM}	Pin 1 to 2			15	V
Reverse Breakdown Voltage	V_{BR}	$I_{BR} = 1\text{mA}$, Pin 1 to 2	17.5	20	23	V
Reverse Leakage Current	I_R	$V_{RWM} = 15\text{V}$, Pin 1 to 2 $T = 25^\circ\text{C}$		<10	100	nA
Peak Pulse Current	I_{PP}	$t_p = 8/20\mu\text{s}$, Pin 1 to 2			40	A
Clamping Voltage	V_C	$t_p = 8/20\mu\text{s}$ Pin 1 to 2			$I_{PP} = 10\text{A}$	25
					$I_{PP} = 40\text{A}$	40
Dynamic Resistance ^{2,3}	R_{DYN}	$t_p = 0.2/100\text{ns}$		0.05		Ω
Junction Capacitance	C_J	$V_R = 0\text{V}$, $f = 1\text{MHz}$			220	pF

μClamp1871P						
Parameter	Symbol	Conditions	Min.	Typ.	Max.	Units
Reverse Stand-Off Voltage	V_{RWM}	Pin 1 to 2			18	V
Reverse Breakdown Voltage	V_{BR}	$I_{BR} = 1\text{mA}$, Pin 1 to 2	20	22	25	V
Reverse Leakage Current	I_R	$V_{RWM} = 18\text{V}$, Pin1 to 2 $T = 25^\circ\text{C}$		<10	100	nA
Peak Pulse Current	I_{PP}	$t_p = 8/20\mu\text{s}$, Pin 1 to 2			35	A
Clamping Voltage	V_C	$t_p = 8/20\mu\text{s}$			$I_{PP} = 10\text{A}$	28
					$I_{PP} = 35\text{A}$	45
Dynamic Resistance ^{2,3}	R_{DYN}	$t_p = 0.2/100\text{ns}$		0.10		Ω
Junction Capacitance	C_J	$V_R = 0\text{V}$, $f = 1\text{MHz}$			225	pF

μClamp2271P

Parameter	Symbol	Conditions	Min.	Typ.	Max.	Units	
Reverse Stand-Off Voltage	V_{RWM}	Pin 1 to 2			22	V	
Reverse Breakdown Voltage	V_{BR}	$I_{BR} = 1\text{mA}$, Pin 1 to 2	25.5	29	33.5	V	
Reverse Leakage Current	I_R	$V_{RWM} = 22\text{V}$, Pin 1 to 2	$T = 25^\circ\text{C}$		<10	100	nA
Peak Pulse Current	I_{PP}	$t_p = 8/20\mu\text{s}$, Pin 1 to 2			25	A	
Clamping Voltage	V_C	$t_p = 8/20\mu\text{s}$, Pin 1 to 2	$I_{PP} = 10\text{A}$		40	V	
			$I_{PP} = 25\text{A}$		55		
Dynamic Resistance ^{2,3}	R_{DYN}	$t_p = 0.2/100\text{ns}$		0.10		Ω	
Junction Capacitance	C_J	$V_R = 0\text{V}$, $f = 1\text{MHz}$			165	pF	

μClamp2671P

Parameter	Symbol	Conditions	Min.	Typ.	Max.	Units	
Reverse Stand-Off Voltage	V_{RWM}	Pin 1 to 2			26	V	
Reverse Breakdown Voltage	V_{BR}	$I_{BR} = 1\text{mA}$, Pin 1 to 2	29	32	35	V	
Reverse Leakage Current	I_R	$V_{RWM} = 5\text{V}$	$T = 25^\circ\text{C}$		<10	100	nA
Peak Pulse Current	I_{PP}	$t_p = 8/20\mu\text{s}$, Pin 1 to 2			23	A	
Clamping Voltage	V_C	$t_p = 8/20\mu\text{s}$	$I_{PP} = 10\text{A}$		50	V	
			$I_{PP} = 23\text{A}$		65		
Dynamic Resistance ^{2,3}	R_{DYN}	$t_p = 0.2/100\text{ns}$		0.15		Ω	
Junction Capacitance	C_J	$V_R = 0\text{V}$, $f = 1\text{MHz}$			155	pF	

μClamp3671P

Parameter	Symbol	Conditions	Min.	Typ.	Max.	Units
Reverse Stand-Off Voltage	V_{RWM}	Pin 1 to 2			36	V
Reverse Breakdown Voltage	V_{BR}	$I_{BR} = 1\text{mA}$, Pin 1 to 2	37		44	V
Reverse Leakage Current	I_R	$V_{RWM} = 36\text{V}$ $T = 25^\circ\text{C}$		<10	100	nA
Peak Pulse Current	I_{PP}	$t_p = 8/20\mu\text{s}$, Pin 1 to 2			18	A
Clamping Voltage	V_C	$t_p = 8/20\mu\text{s}$			48	V
					80	
Dynamic Resistance ^{2,3}	R_{DYN}	$t_p = 0.2/100\text{ns}$		0.29		Ω
Junction Capacitance	C_J	$V_R = 0\text{V}$, $f = 1\text{MHz}$			150	pF

Notes

- 1) Measured with a 40dB attenuator, 50 Ohm scope input impedance, 2GHz bandwidth. ESD gun return path connected to ESD ground plane.
- 2) Transmission Line Pulse Test (TLP) Settings: $t_p = 100\text{ns}$, $t_r = 0.2\text{ns}$, I_{TLP} and V_{TLP} averaging window: $t_1 = 70\text{ns}$ to $t_2 = 90\text{ns}$.
- 3) Dynamic resistance calculated from $I_{TLP} = 4\text{A}$ to $I_{TLP} = 16\text{A}$

Typical Characteristics

Non-Repetitive Peak Pulse Power vs. Pulse Time

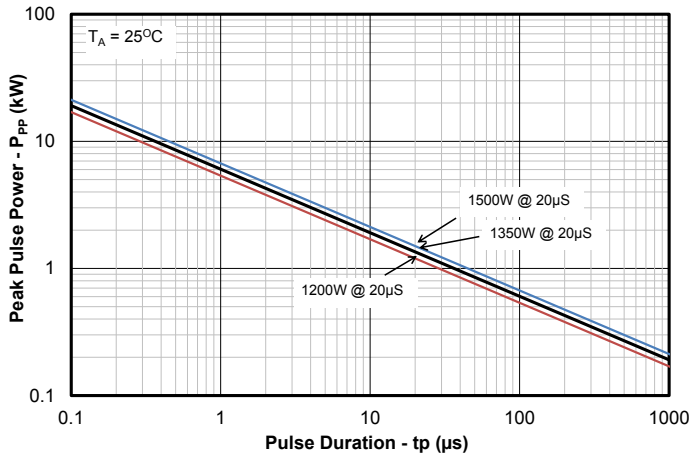

Clamping Voltage vs. Peak Pulse Current ($t_p = 8/20 \mu\text{s}$)

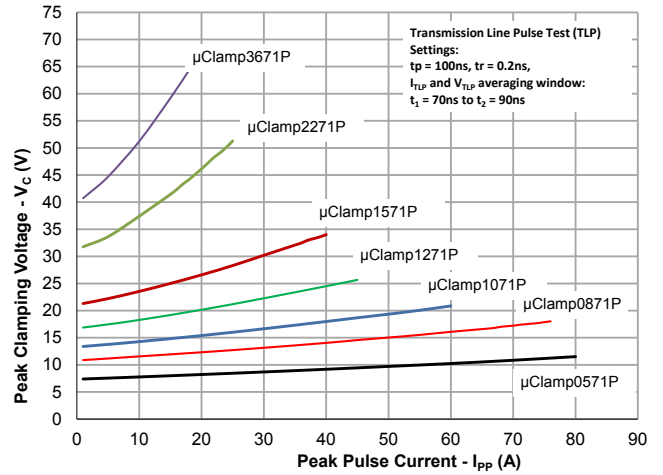

Forward Voltage vs. Peak Pulse Current ($t_p = 8/20 \mu\text{s}$)

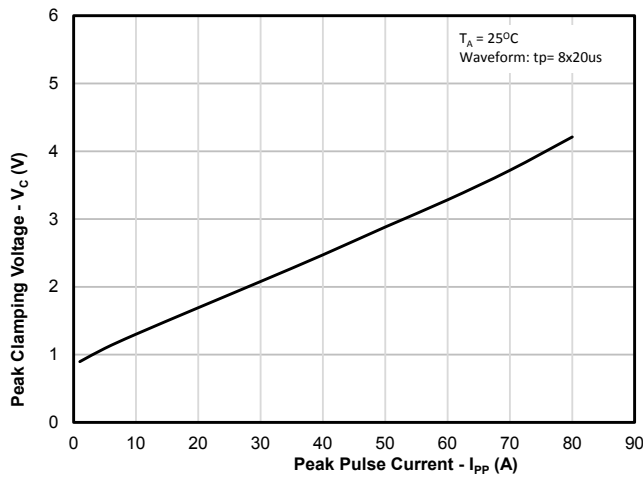

TLP Characteristic

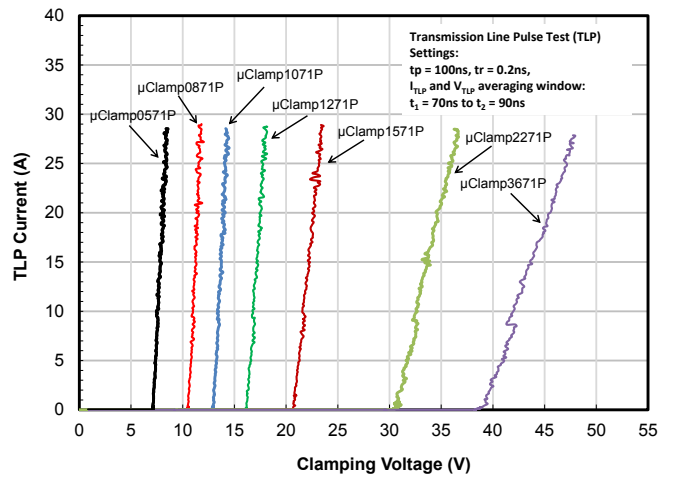

ESD Clamping - μClamp0571P (+8kV Contact per IEC 61000-4-2)

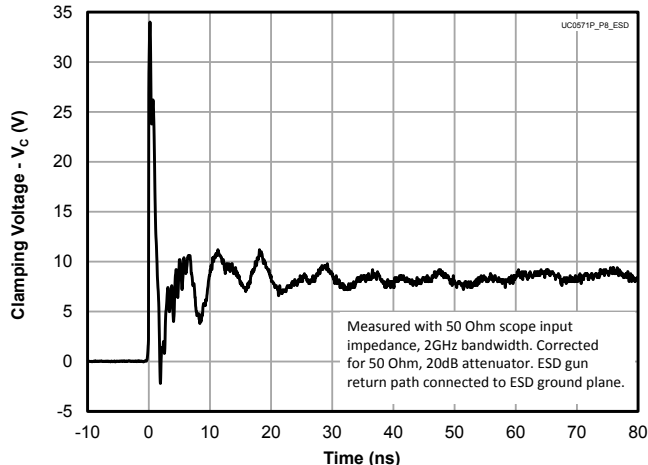

ESD Clamping - μClamp0571P (-8kV Contact per IEC 61000-4-2)

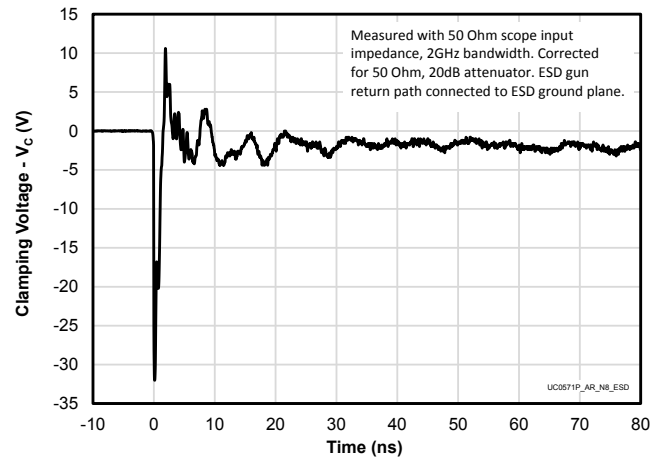

Typical Characteristics (Continued)

ESD Clamping - μ Clamp0871P
 (+8kV Contact per IEC 61000-4-2)

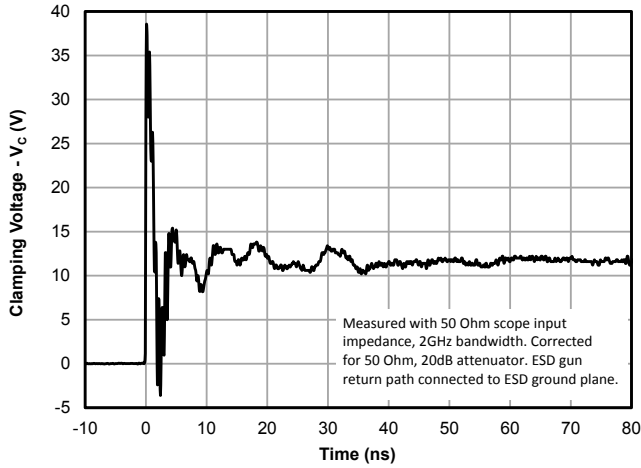

ESD Clamping - μ Clamp0871P
 (-8kV Contact per IEC 61000-4-2)

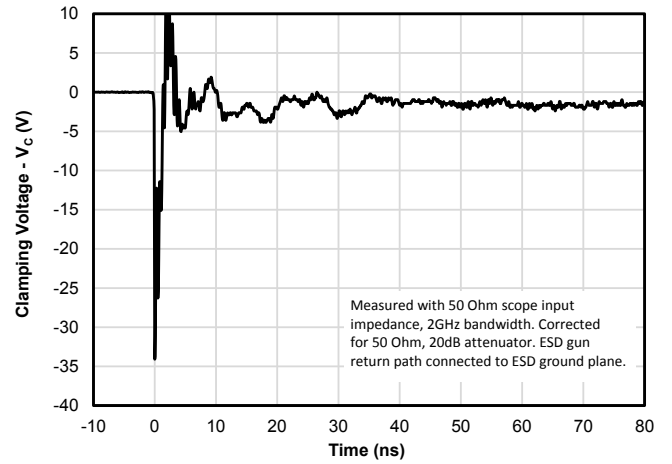

ESD Clamping - μ Clamp1071P
 (+8kV Contact per IEC 61000-4-2)

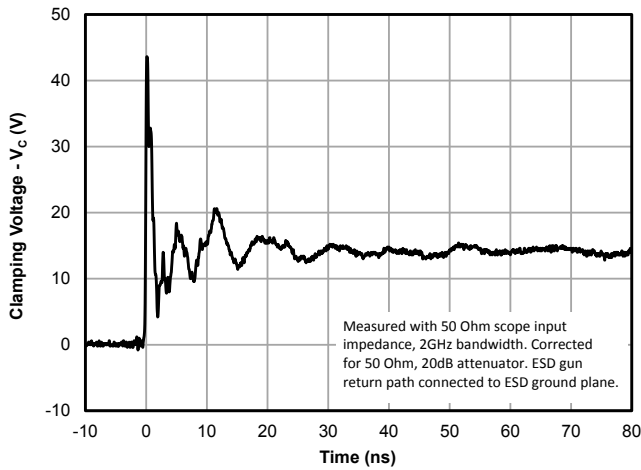

ESD Clamping - μ Clamp1071P
 (-8kV Contact per IEC 61000-4-2)

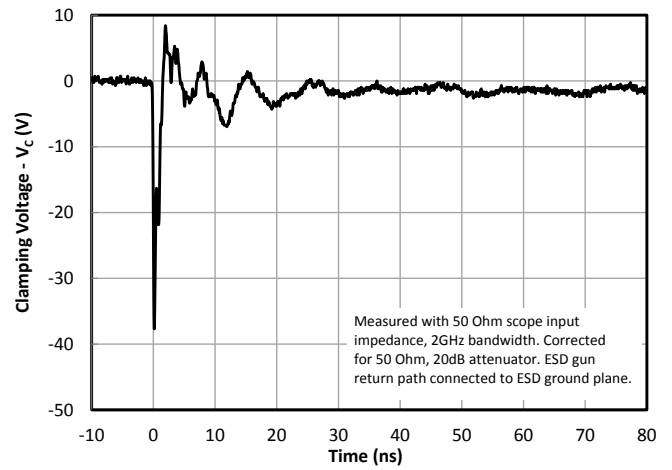

ESD Clamping - μ Clamp1271P
 (+8kV Contact per IEC 61000-4-2)

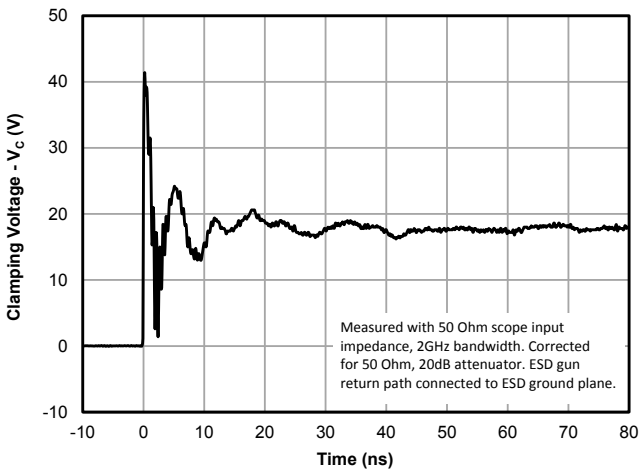

ESD Clamping - μ Clamp1271P
 (-8kV Contact per IEC 61000-4-2)

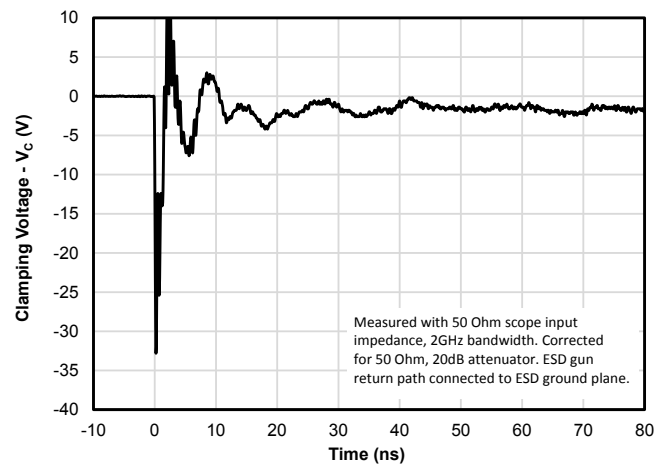

Typical Characteristics (Continued)

ESD Clamping - μ Clamp1571P
 (+8kV Contact per IEC 61000-4-2)

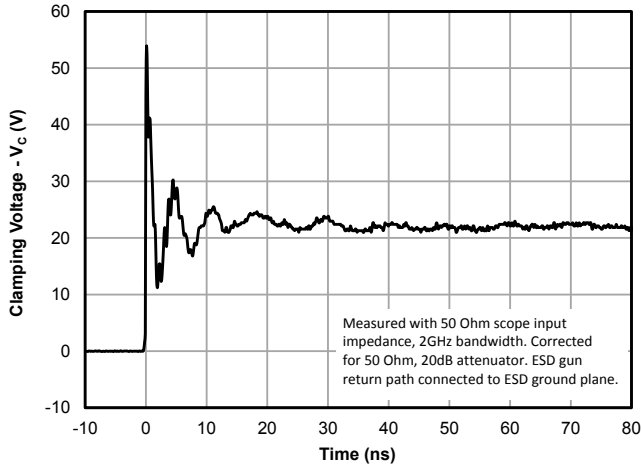

ESD Clamping - μ Clamp1571P
 (-8kV Contact per IEC 61000-4-2)

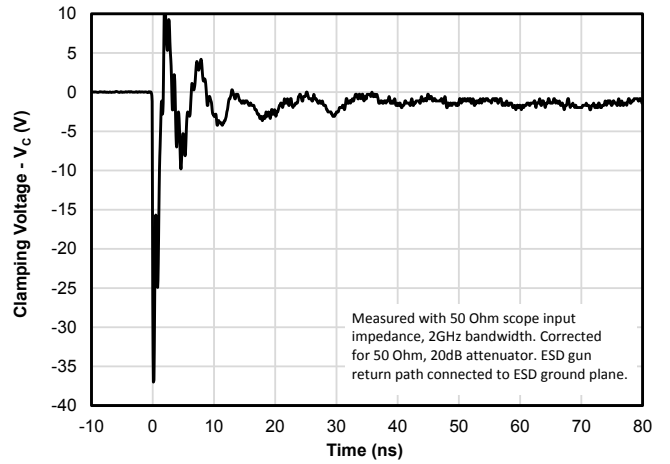

ESD Clamping - μ Clamp1871P
 (+8kV Contact per IEC 61000-4-2)

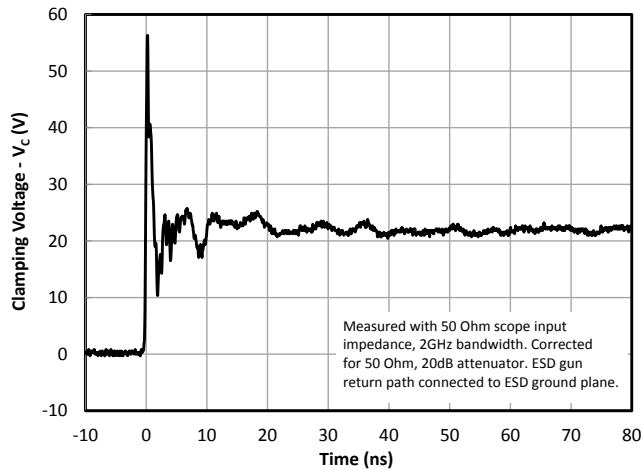

ESD Clamping - μ Clamp1871P
 (-8kV Contact per IEC 61000-4-2)

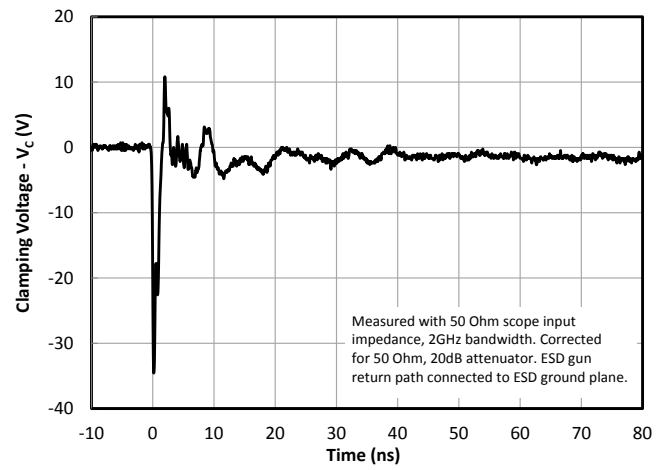

ESD Clamping - μ Clamp2271P
 (+8kV Contact per IEC 61000-4-2)

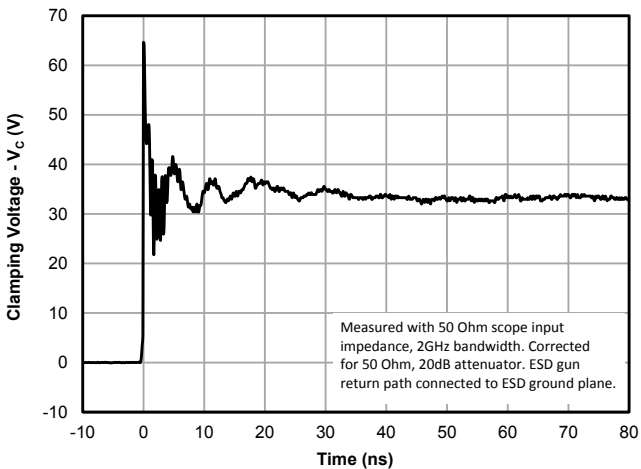

ESD Clamping - μ Clamp2271P
 (-8kV Contact per IEC 61000-4-2)

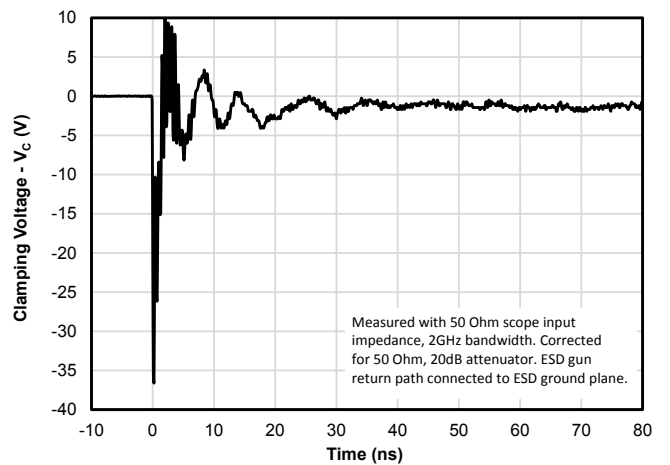

Typical Characteristics (Continued)

ESD Clamping - μ Clamp2671P
 (+8kV Contact per IEC 61000-4-2)

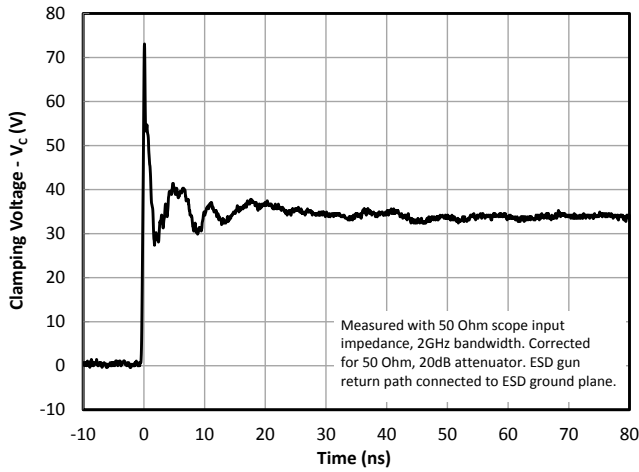

ESD Clamping - μ Clamp2671P
 (-8kV Contact per IEC 61000-4-2)

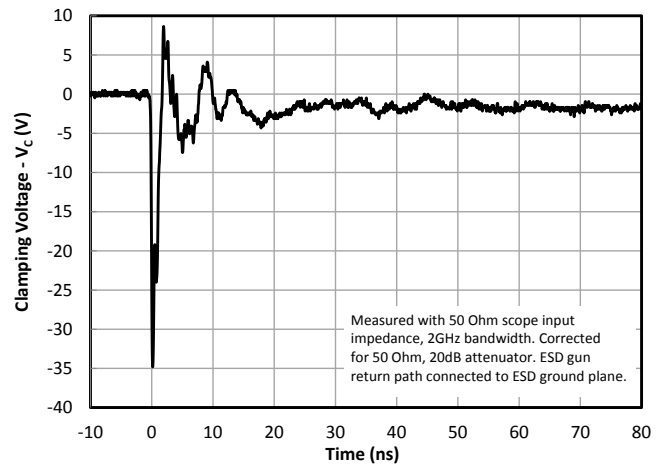

ESD Clamping - μ Clamp3671P
 (+8kV Contact per IEC 61000-4-2)

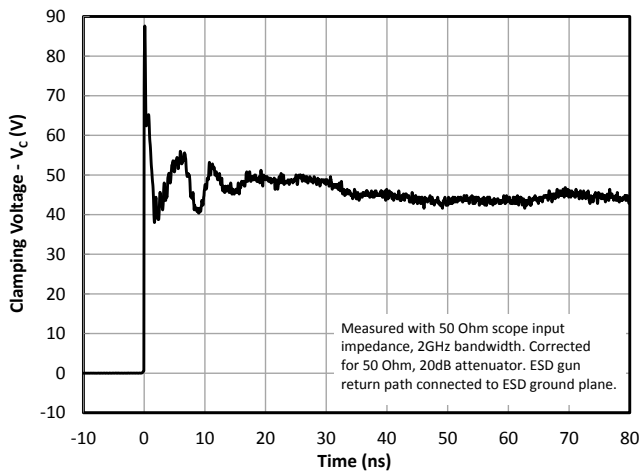

ESD Clamping - μ Clamp3671P
 (-8kV Contact per IEC 61000-4-2)

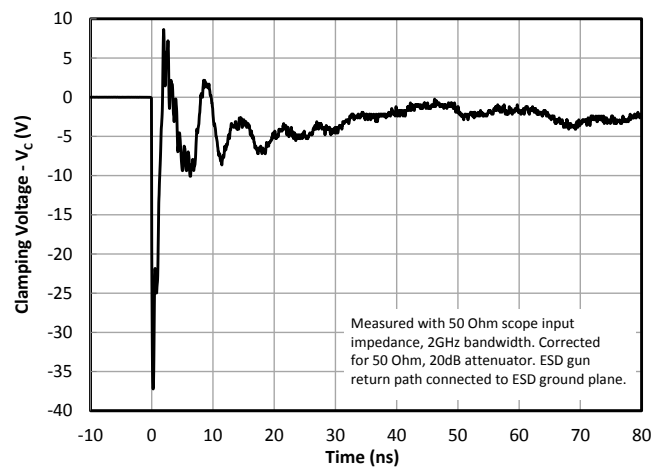

Application Information

Assembly Guidelines

The table below provides Semtech’s recommended assembly guidelines for mounting this device. The figure at the right details Semtech’s recommended aperture based on the below recommendations. Note that these are only recommendations and should serve only as a starting point for design since there are many factors that affect the assembly process. The exact manufacturing parameters will require some experimentation to get the desired solder application.

Assembly Parameter	Recommendation
Solder Stencil Design	Laser cut, Electro-polished
Aperture shape	Rectangular with rounded corners
Solder Stencil Thickness	0.125 mm (0.005")
Solder Paste Type	Type 3 size sphere or smaller
Solder Reflow Profile	per JEDEC J-STD-020
PCB Solder Pad Design	Non-Solder mask defined
PCB Pad Finish	OSP OR NiAu

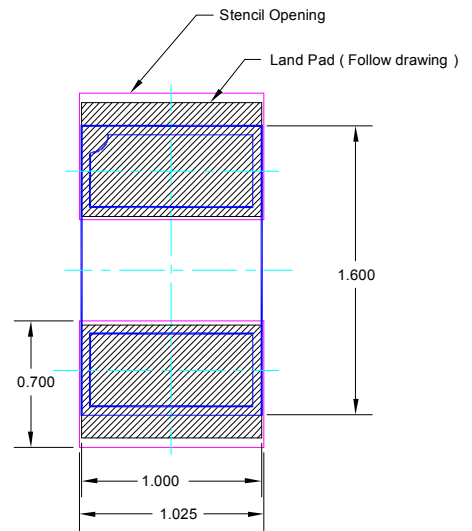

All Dimensions are in mm.

Land Pad.
 Stencil opening
 Component

Recommended Mounting Pattern

Outline Drawing - SGP1610N2

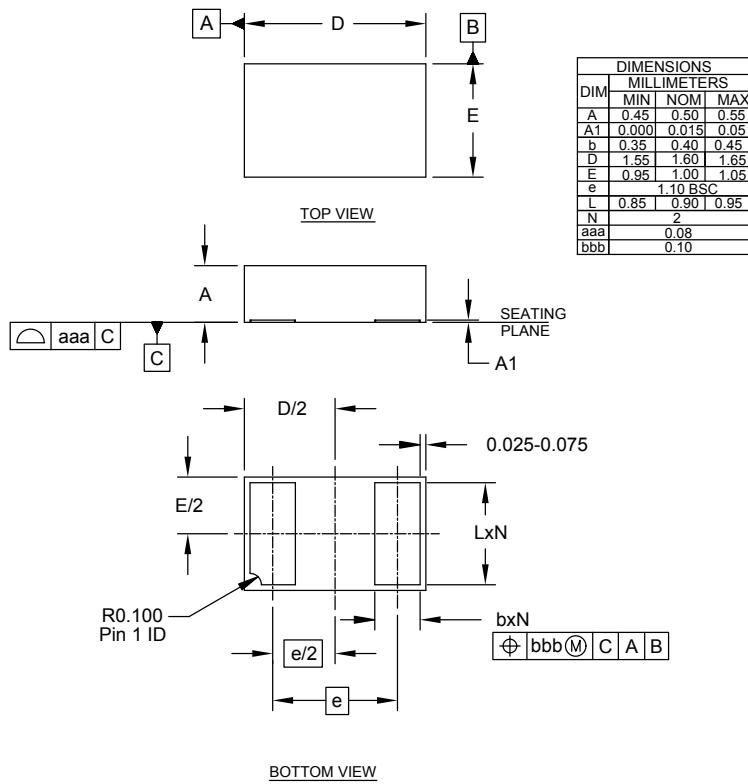

NOTES:
1. CONTROLLING DIMENSIONS ARE IN MILLIMETERS (ANGLES IN DEGREES).

Land Pattern - SGP1610N2

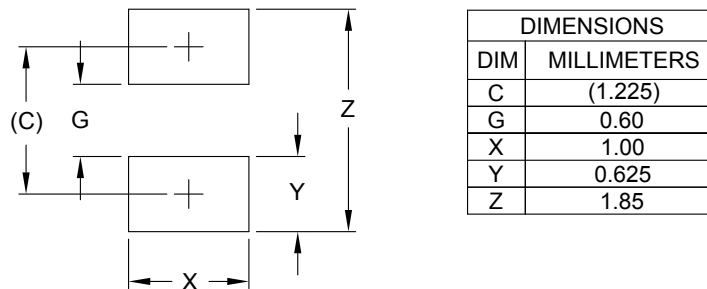

NOTES:
1. CONTROLLING DIMENSIONS ARE IN MILLIMETERS (ANGLES IN DEGREES).
2. THIS LAND PATTERN IS FOR REFERENCE PURPOSES ONLY. CONSULT YOUR MANUFACTURING GROUP TO ENSURE YOUR COMPANY'S MANUFACTURING GUIDELINES ARE MET.

Marking Code

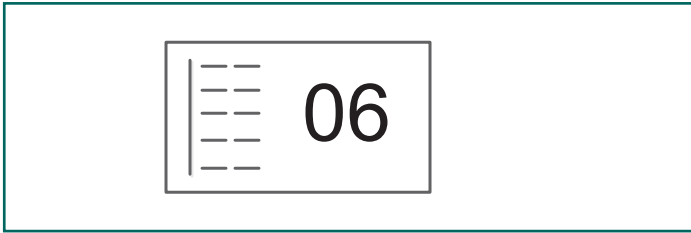

Tape and Reel Specification

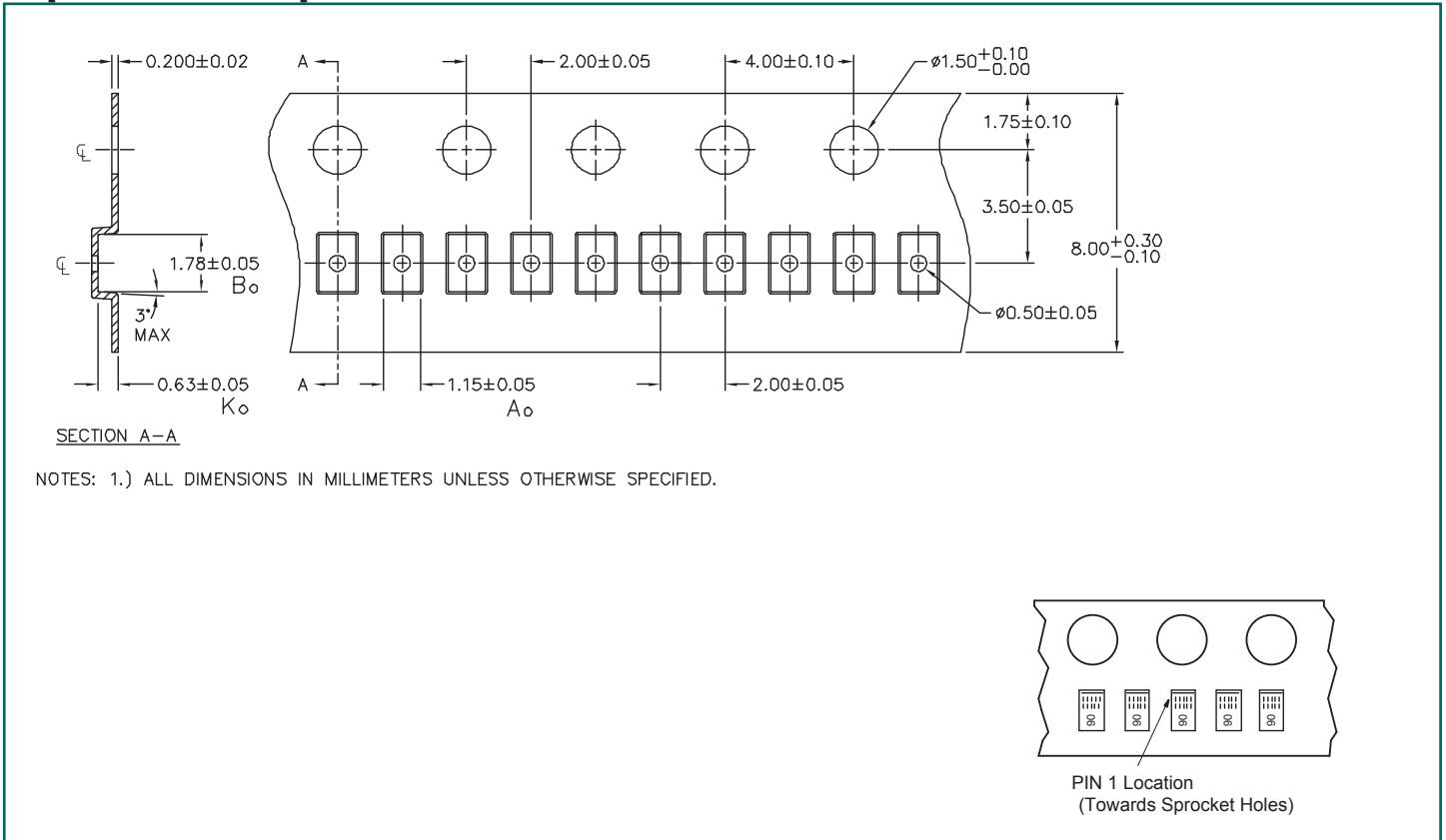

Ordering Information

Part Number	Marking Code	Working Voltage	Qty per Reel
μClamp0571P.TNT	06	5V	10,000
μClamp0871P.TNT	11	8V	10,000
μClamp1071P.TNT	12	10V	10,000
μClamp1271P.TNT	16	12V	10,000
μClamp1571P.TNT	18	15V	10,000
μClamp1871P.TNT	24	18V	10,000
μClamp2271P.TNT	26	22V	10,000
μClamp2671P.TNT	30	26V	10,000
μClamp3671P.TNT	37	36V	10,000



Important Notice

Information relating to this product and the application or design described herein is believed to be reliable, however such information is provided as a guide only and Semtech assumes no liability for any errors in this document, or for the application or design described herein. Semtech reserves the right to make changes to the product or this document at any time without notice. Buyers should obtain the latest relevant information before placing orders and should verify that such information is current and complete. Semtech warrants performance of its products to the specifications applicable at the time of sale, and all sales are made in accordance with Semtech's standard terms and conditions of sale.

SEMTECH PRODUCTS ARE NOT DESIGNED, INTENDED, AUTHORIZED OR WARRANTED TO BE SUITABLE FOR USE IN LIFE-SUPPORT APPLICATIONS, DEVICES OR SYSTEMS, OR IN NUCLEAR APPLICATIONS IN WHICH THE FAILURE COULD BE REASONABLY EXPECTED TO RESULT IN PERSONAL INJURY, LOSS OF LIFE OR SEVERE PROPERTY OR ENVIRONMENTAL DAMAGE. INCLUSION OF SEMTECH PRODUCTS IN SUCH APPLICATIONS IS UNDERSTOOD TO BE UNDERTAKEN SOLELY AT THE CUSTOMER'S OWN RISK. Should a customer purchase or use Semtech products for any such unauthorized application, the customer shall indemnify and hold Semtech and its officers, employees, subsidiaries, affiliates, and distributors harmless against all claims, costs damages and attorney fees which could arise.

The Semtech name and logo are registered trademarks of the Semtech Corporation. All other trademarks and trade names mentioned may be marks and names of Semtech or their respective companies. Semtech reserves the right to make changes to, or discontinue any products described in this document without further notice. Semtech makes no warranty, representation or guarantee, express or implied, regarding the suitability of its products for any particular purpose. All rights reserved.

© Semtech 2017

Contact Information

Semtech Corporation
200 Flynn Road, Camarillo, CA 93012
Phone: (805) 498-2111, Fax: (805) 498-3804
www.semtech.com

Looking for pricing, stock, or lifecycle information?

Click below to explore more details on WIN SOURCE:

- ⊖ [View UCLAMP0871P.TNT on WIN SOURCE](#)
- ⊖ [Semtech Corporation](#) Information

Optimize Your Supply Chain with WIN SOURCE Solutions

- ✓ Global Sourcing Solution
- ✓ Obsolete Management
- ✓ Cost Control Management
- ✓ Shortage Management
- ✓ Alternative Solution
- ✓ Excess Inventory Management