



**THE DATASHEET OF
DC0710J5005AHF**





**Ultra Low Profile 0805
5 dB Directional Coupler**

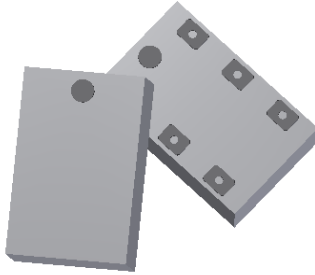

Description:

The DC0710J5005AHF is a low cost, low profile sub-miniature high performance 5 dB directional coupler in an easy to use RoHS compliant, Halogen Free surface mount package. It is designed for 700 – 1000MHz applications including: WCDMA, CDMA, LTE, and GSM800 / 900 applications. The DC0710J5005AHF is ideal for power detection, signal injection and other applications where low insertion loss signal monitoring is required. The DC0710J5005AHF is available on tape and reel for pick and place high volume manufacturing. All of the Xinger components are constructed from ceramic filled PTFE composites which possess excellent electrical and mechanical stability. All parts have been subjected to rigorous qualification testing and units are 100% RF tested.

Detailed Electrical Specifications: Specifications subject to change without notice.

Features: <ul style="list-style-type: none"> • 700 – 1000 MHz • Mean Coupling 5dB • Ultra Low Insertion Loss • WCDMA, CDMA, GSM • LTE Bands: 5,6,8,12, 13,14,17,18,19,20 • Surface Mountable • Tape & Reel • RoHS Compliant • Halogen Free • 100% RF Tested • -55°C to 140°C 	ROOM (25°C)														
	Frequency (MHz)	Mean Coupling (dB)			Insertion loss (dB)		Return Loss (dB)		Directivity (dB)		Phase Balance (deg)		Frequency Sensitivity (dB)		Power Handling (watts) @85°C
		Min	Typ.	Max	Typ.	Max	Typ.	Min	Typ.	Min	Typ.	Max	Typ.	Max	Max
	700 - 1000	4.5	5.0	5.5	0.4	0.6	21	18	23	19	1.4	3	0.20	0.30	2
869 - 894	4.5	5.0	5.5	0.4	0.5	24	20	29	22	1.0	3	0.01	0.10	2	
925 - 960	4.5	5.0	5.5	0.4	0.6	22	19	25	20	1.2	3	0.02	0.10	2	

*Specification based on performance of unit properly installed on microstrip printed circuit boards with 50 Ω nominal impedance.

Outline Drawing

Top View (Nearside)

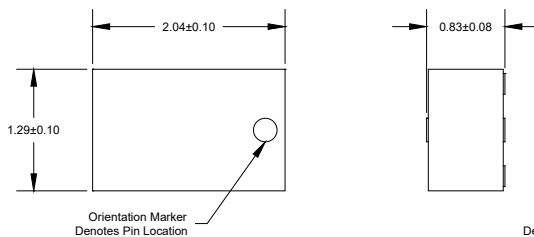

Bottom View (Farside)

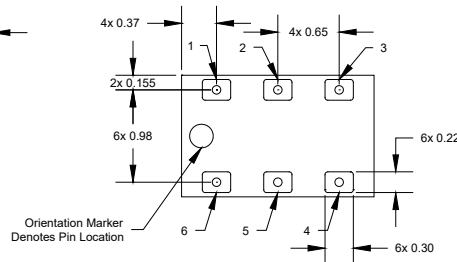

Pin	Configuration-1	Configuration-2	Configuration-3	Configuration-4
1	Input	Isolated	Direct	Coupled
2	GND	GND	GND	GND
3	Isolated	Input	Coupled	Direct
4	Direct	Coupled	Input	Isolated
5	GND	GND	GND	GND
6	Coupled	Direct	Isolated	Input

Mechanical Outline
-Dimensions are in Millimeters
-Tolerances are Non-Cumulative

Typical Performance: 600 MHz to 1100 MHz (Configuration 1)

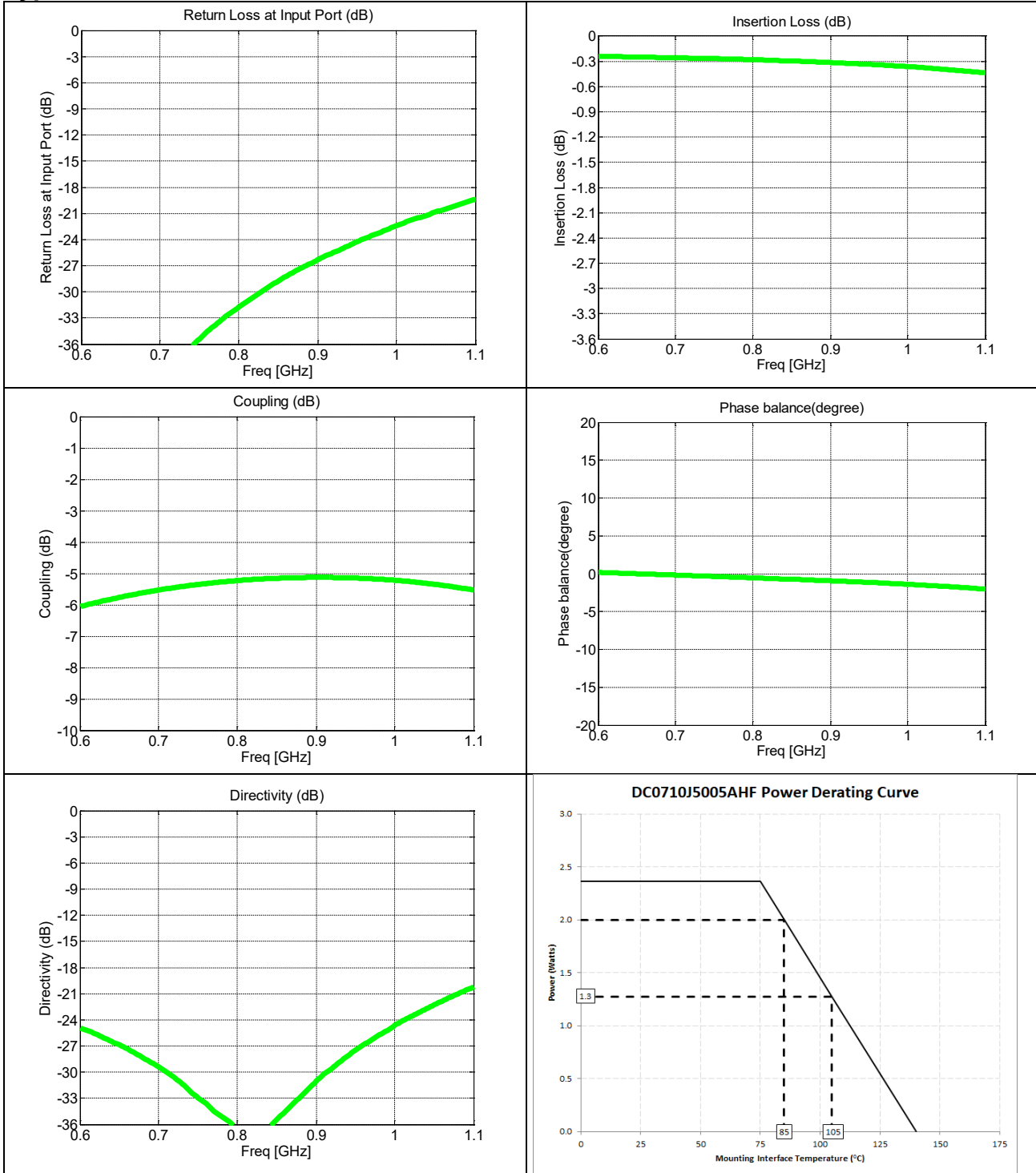

Wideband Performance: 10MHz to 8010MHz (Configuration 1)

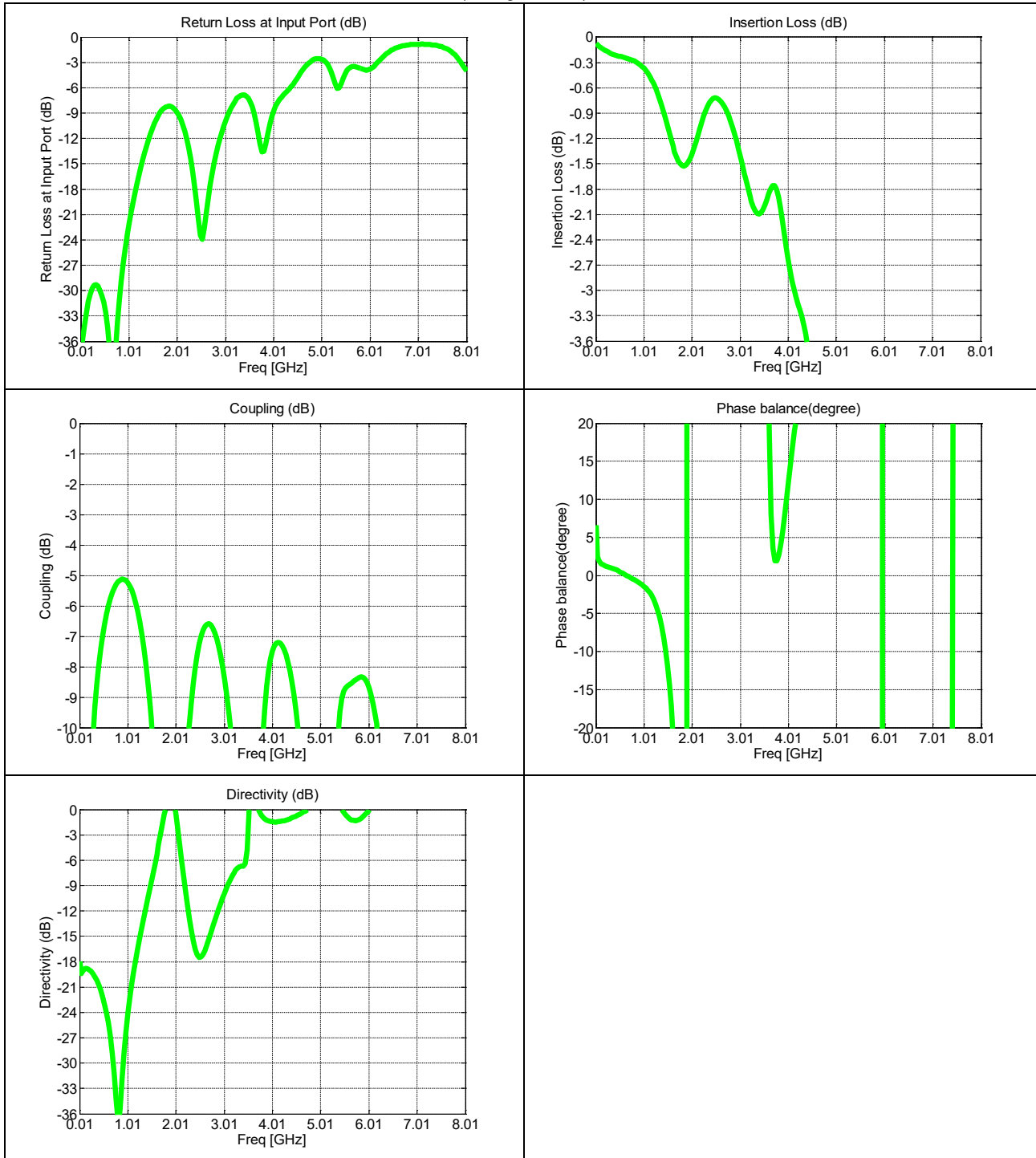

Pin Configuration

Configuration	Pin 1	Pin 3	Pin 4	Pin 6
Splitter	Input	Isolated	-2dB <Θ-90	-5dB <Θ
Splitter	Isolated	Input	-5dB <Θ	-2dB <Θ-90
Splitter	-2dB <Θ-90	-5dB <Θ	Input	Isolated
Splitter	-5dB <Θ	-2dB <Θ-90	Isolated	Input

Definition of Measured Specifications

Parameter	Definition	Mathematical Representation
Return Loss	The impedance match of the coupler to a 50Ω system. Return Loss is an alternate means to express VSWR.	$\text{Return Loss(dB)} = 20 \log \frac{\text{VSWR} + 1}{\text{VSWR} - 1}$
Directivity	The power at the isolated port divided by the power at the coupled port	$\text{Directivity(dB)} = 10 \log \frac{P_{\text{iso}}}{P_{\text{cpl}}}$
Insertion Loss	The input power divided by the sum of the power at the two output ports.	$\text{Insertion Loss(dB)} = 10 \log \frac{P_{\text{in}}}{P_{\text{cpl}} + P_{\text{direct}}}$
Mean Coupling	At a given frequency (ω_n), coupling is the input power divided by the power at the coupled port. Mean coupling is the average value of the coupling values in the band. N is the number of frequencies in the band.	$\text{Coupling(dB)} = C(\omega_n) = 10 \log \frac{P_{\text{in}}(\omega_n)}{P_{\text{cpl}}(\omega_n)}$ $\text{Mean Coupling(dB)} = \frac{\sum_{n=1}^N C(\omega_n)}{N}$
Phase Balance	The difference in phase angle between the two output ports.	Phase at coupled port - Phase at direct port
Frequency sensitivity	The decibel difference between the maximum in band coupling value and the minimum in band coupling value.	$(\text{Max Coupling (dB)} - \text{Min Coupling (dB)})/2$

Mounting Configuration:

In order for Xinger surface mount components to work optimally, the proper impedance transmission lines must be used to connect to the RF ports. If this condition is not satisfied, insertion loss, Isolation and VSWR may not meet published specifications.

All of the Xinger components are constructed from organic PTFE based composites which possess excellent electrical and mechanical stability. Xinger components are compliant to a variety of ROHS and Green standards and ready for Pb-free soldering processes. Pads are Gold plated with a Nickel barrier.

An example of the PCB footprint used in the testing of these parts is shown below. In specific designs, the transmission line widths need to be adjusted to the unique dielectric coefficients and thicknesses as well as varying pick and place equipment tolerances.

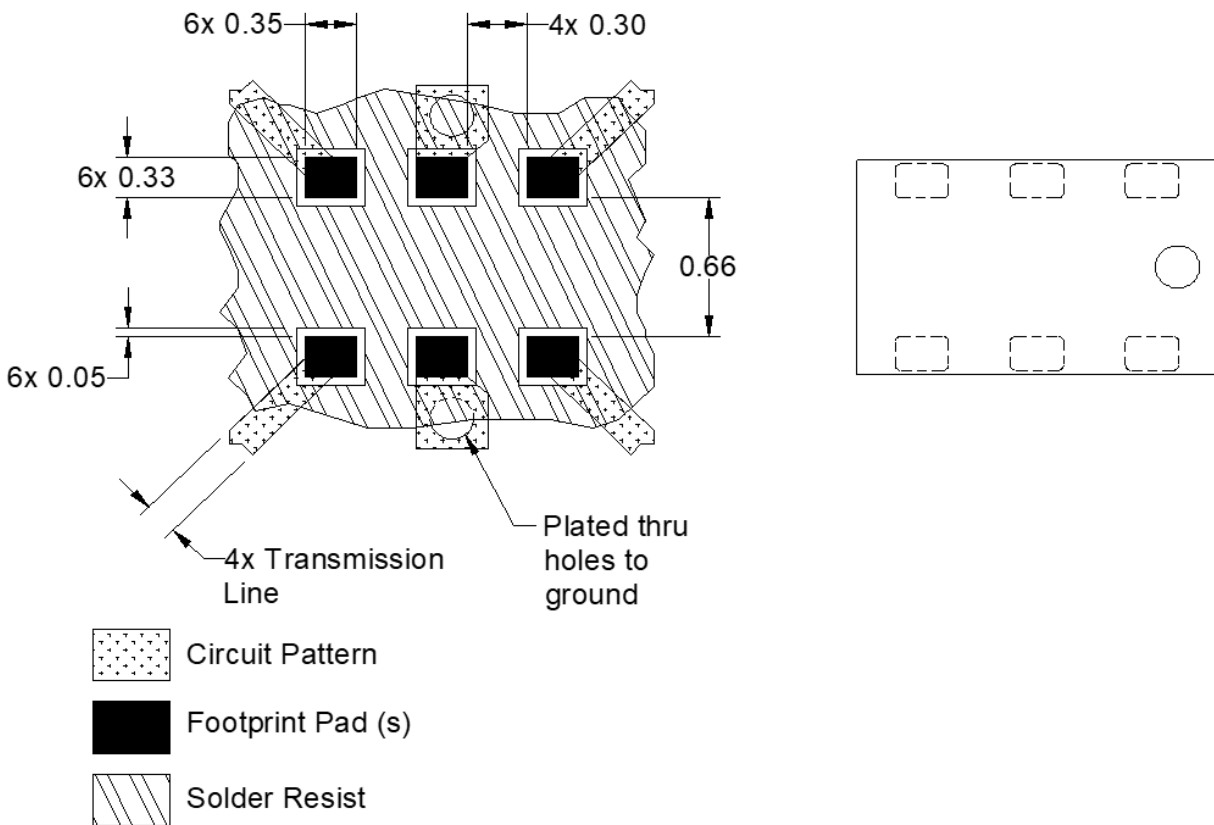

Dimensions are in Millimeters
Mounting Footprint

Packaging and Ordering Information

Parts are available in reel and are packaged per EIA 481-D. Parts are oriented in tape and reel as shown below. Minimum order quantities are 4000 per reel.

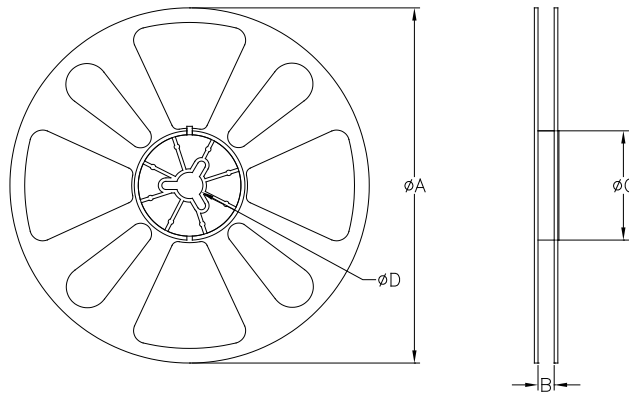
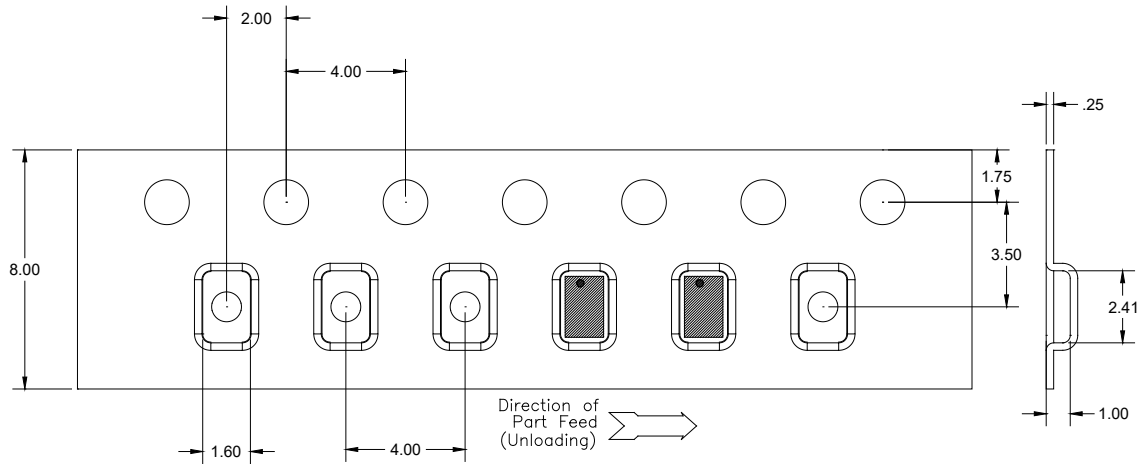

TABLE 1		
QUANTITY/REEL	REEL DIMENSIONS mm	
4000	ϕA	177.80
	B	8.00
	ϕC	50.80
	ϕD	13.00

Looking for pricing, stock, or lifecycle information?

Click below to explore more details on WIN SOURCE:

 [View DC0710J5005AHF on WIN SOURCE](#)

 [TTM Technologies](#) Information

Optimize Your Supply Chain with WIN SOURCE Solutions

-  Global Sourcing Solution
-  Obsolete Management
-  Cost Control Management
-  Shortage Management
-  Alternative Solution
-  Excess Inventory Management