



THE DATASHEET OF
34160



34160 ✓ ACTIVE

PLASTI-GRIP

TE Internal #: 34160

Closed Ring Tongue Terminal, 16 – 14 AWG, #8 / M4 Stud, 4.34 mm [.171 in] Stud Diameter, Closed Barrel, Straight, Tin Plating, PLASTI-GRIP

[View on TE.com >](#)



Terminals & Splices > Ring Terminals

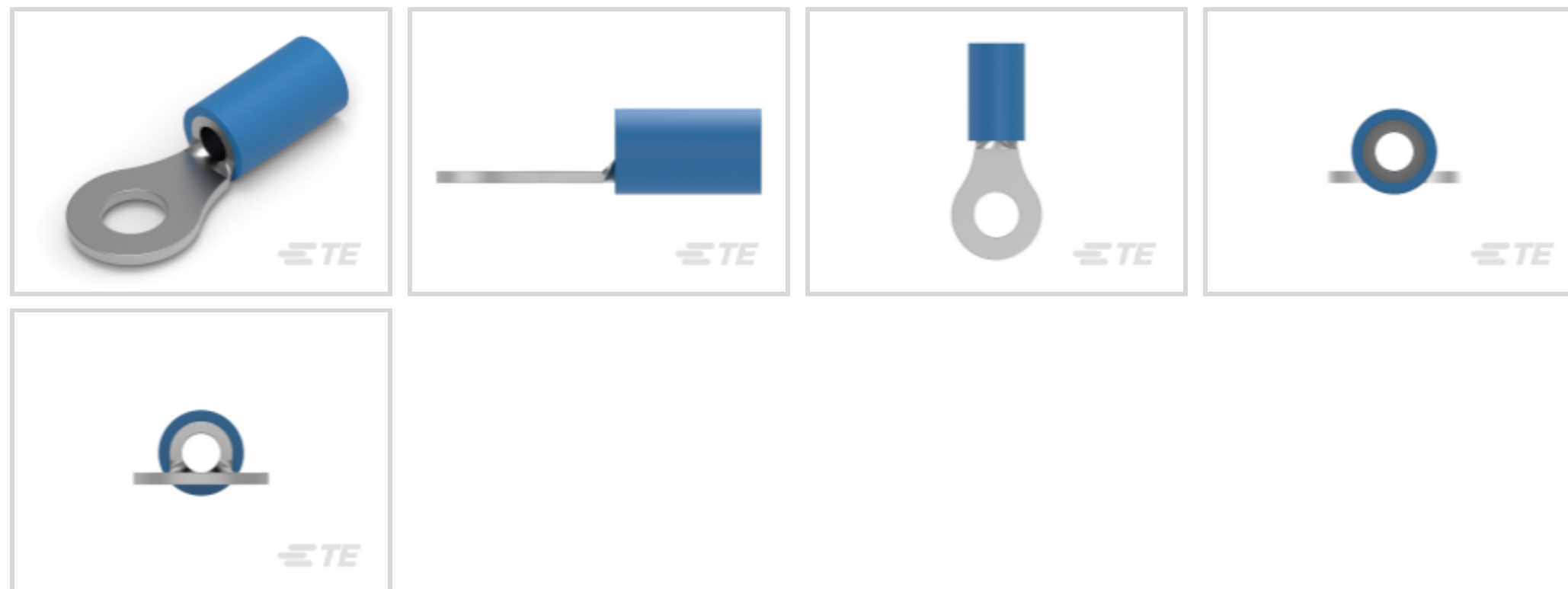

Ring Terminal Product Type: Closed Ring Tongue Terminal

Wire Size: 2050 – 5180 CMA

Stud Size: #8, M4

Features

Product Type Features

Ring Terminal Product Type	Closed Ring Tongue Terminal
Stud Size	#8, M4
Sealable	No
Wire Insulation Support Retention Type	Insulation Support

Configuration Features

Number of Holes	1
-----------------	---

Electrical Characteristics

Voltage Rating	600 V
----------------	-------

Body Features

Product Weight	.932 g
----------------	--------

Contact Features

Barrel Type	Closed
Terminal Orientation	Straight
Terminal Plating Material	Tin

Mechanical Attachment

Wire Insulation Support	With
-------------------------	------

Dimensions

Wire Size	2050 – 5180 CMA
Stud Diameter	4.34 mm [.171 in]
Tongue Thickness	.79 mm [.031 in]
Product Length	22.12 mm [.87 in]
Compatible Insulation Diameter (Max)	4.9 mm [.193 in]
Compatible Insulation Diameter Range	3 – 4.9 mm [.118 – .193 in]

Usage Conditions

Insulation Option	Partially Insulated
Operating Temperature Range	0 – 105 °C [0 – 221 °F]

Operation/Application

Compatible With Wire Base Material	Copper
Compatible With Wire Plating Material	Tin

Industry Standards

Government Qualified Terminal	No
-------------------------------	----

Packaging Features

Packaging Quantity	1000
Packaging Method	Loose Piece

Product Compliance

[For compliance documentation, visit the product page on TE.com>](#)

EU RoHS Directive 2011/65/EU	Compliant
EU ELV Directive 2000/53/EC	Compliant
China RoHS 2 Directive MIIT Order No 32, 2016	有害物质含量符合标准要求 No Restricted Substance(s) Above Threshold
EU REACH Regulation (EC) No. 1907/2006	Current ECHA Candidate List: JUNE 2025 (250) Candidate List Declared Against: JUNE 2025 (250) Does not contain REACH SVHC
Halogen Content	Not Low Halogen - contains Br or Cl > 900 ppm.
Solder Process Capability	Not applicable for solder process capability

Product Compliance Disclaimer

This information is provided based on reasonable inquiry of our suppliers and represents our current actual knowledge based on the information they provided. This information is subject to change. The part numbers that TE has identified as EU RoHS compliant have a maximum concentration of 0.1% by weight in homogenous materials for lead, hexavalent chromium, mercury, PBB, PBDE, DBP, BBP, DEHP, DIBP, and 0.01% for cadmium, or qualify for an exemption to these limits as defined in the Annexes of Directive 2011/65/EU (RoHS2). Finished electrical and electronic equipment products will be CE marked as required by Directive 2011/65/EU. Components may not be CE marked. Additionally, the part numbers that TE has identified as EU ELV compliant have a maximum concentration of 0.1% by weight in homogenous materials for lead, hexavalent chromium, and mercury, and 0.01% for cadmium, or qualify for an exemption to these limits as defined in the Annexes of Directive 2000/53/EC (ELV). Regarding the REACH Regulation, the information TE provides on SVHC in articles for this part number is based on the latest European Chemicals Agency (ECHA) 'Guidance on requirements for substances in articles' posted at this URL: <https://echa.europa.eu/guidance-documents/guidance-on-reach>

Compatible Parts



TE Part # 169400
CERTI-LOK FRAME W/O DIES



TE Part # 47387
DAHT PG PIDG 20-14 ASSY



TE Part # 59250
T-HEAD PIDG 26-14 ASSY



TE Part # 59170
T-HEAD PIDG SH 26-14 ASSY



TE Part # 58433-3
PRO CR ASSY, RBY IS9252

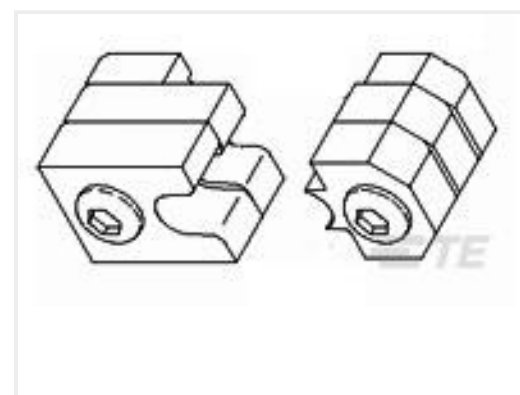

TE Part # 47807-1
DIES PIDG 16-14 DIE SET



TE Part # 58423-1
DIE, RBY IS9252



TE Part # 2063030-1
SDE DIESET, RBY, UL



TE Part # 539691-2
ERGO DIE R.B.Y



TE Part # 169404
CERTI-LOK DIE



TE Part # 1377173-4
SMP 0-0034160-0



TE Part # 525691
DAHT PG PIDG 16-14 ASSY



Also in the Series | **PLASTI-GRIP**

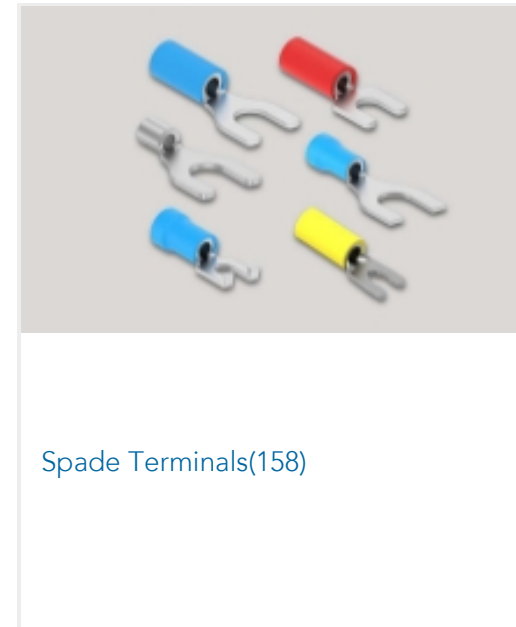
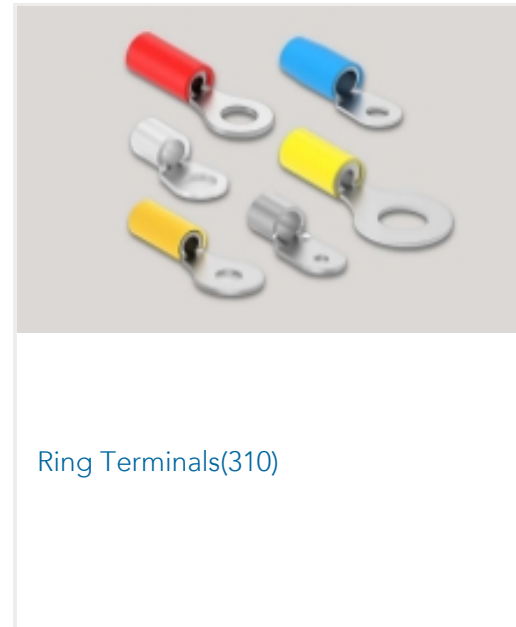
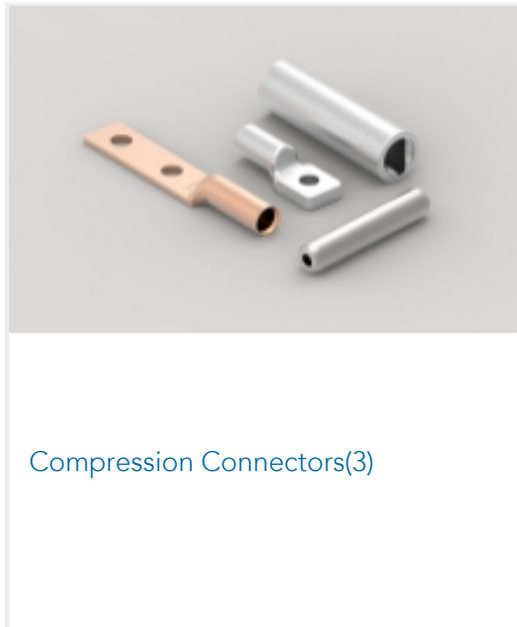

Customers Also Bought

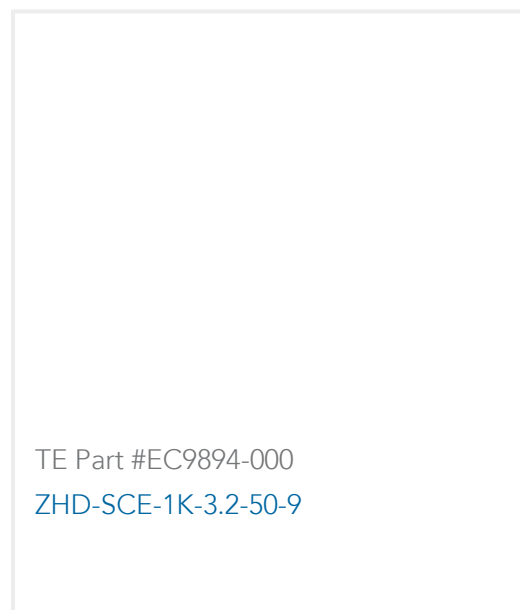

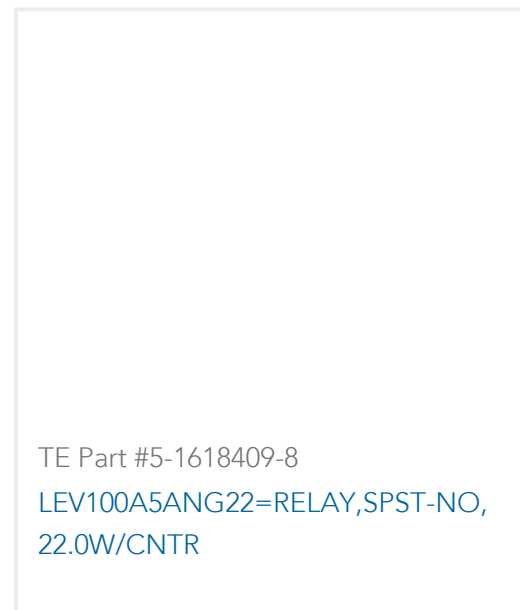

Documents

Product Drawings

[TERMINAL,PG R 16-14 8](#)

English

CAD Files

[3D PDF](#)

3D

Customer View Model

[ENG_CVM_CVM_34160_AD.2d_dxf.zip](#)

English

Customer View Model

[ENG_CVM_CVM_34160_AD.3d_igs.zip](#)

English

Customer View Model

[ENG_CVM_CVM_34160_AD.3d_stp.zip](#)

English

[3D PDF](#)

English

Customer View Model

[ENG_CVM_34160_R.2d_dxf.zip](#)

English

Customer View Model

[ENG_CVM_34160_R.3d_igs.zip](#)

English

Customer View Model

[ENG_CVM_34160_R.3d_stp.zip](#)

English

By downloading the CAD file I accept and agree to the [Terms and Conditions](#) of use.

Datasheets & Catalog Pages

[PLASTI GRIP_QRG](#)

English

Product Specifications

[Application Specification](#)

English



Agency Approvals

UL Report

English

UL Report

English

UL Report

English

Looking for pricing, stock, or lifecycle information?

Click below to explore more details on WIN SOURCE:

 [View 34160](#) on WIN SOURCE

 [TE Connectivity](#) Information

Optimize Your Supply Chain with WIN SOURCE Solutions

-  Global Sourcing Solution
-  Obsolete Management
-  Cost Control Management
-  Shortage Management
-  Alternative Solution
-  Excess Inventory Management