

Current Transducer HTFS 200 ... 800-P

For the electronic measurement of currents: DC, AC, pulsed..., with galvanic separation between the primary circuit and the secondary circuit.



All data are given with $R_L = 10\text{ k}\Omega$

Electrical data

Primary nominal RMS current I_{PN} (A)	Primary current measuring range I_{PM} (A)	Type
200	± 300	HTFS 200-P
400	± 600	HTFS 400-P
600	± 900	HTFS 600-P
800	± 1200	HTFS 800-P
U_{out}	Output voltage (Analog) @ I_p $I_p = 0$	$U_{ref} \pm (1.25 \cdot I_p / I_{PN})$ V $U_{ref} \pm 0.025$ V
U_{ref}	Reference voltage	$1/2 U_C \pm 0.025$ V
	U_{ref} Output impedance	typ. 200 Ω
	U_{ref} Load impedance	≥ 200 k Ω
R_L	Load resistance	≥ 2 k Ω
R_{out}	Output internal resistance	< 5 Ω
C_L	Load capacitance	$= 4.7$ nF
U_C	Supply voltage ($\pm 5\%$)	5 V
I_C	Current consumption @ $U_C = 5\text{ V}$	19 (typ) mA 25 (max) mA

Accuracy - Dynamic performance data

ϵ_{tot}	Total error ²⁾ @ I_{PN} , $T_A = 25^\circ\text{C}$	$\leq \pm 1$	%
ϵ_L	Linearity error 0 ... $1.5 \times I_{PN}$	$\leq \pm 0.5$	%
TCU_{OE}	Temperature coefficient of U_{OE} @ $I_p = 0$	$\leq \pm 0.1$	mV/K
TCU_{ref}	Temperature coefficient of U_{ref}	$\leq \pm 190$	ppm/K
TCS	Temperature coefficient of U_{out}	$\leq \pm 420$	ppm/K
U_{OM}	Magnetic offset voltage @ $I_p = 0$ and specified R_M , after an overload of $3 \times I_{PNDC} < \pm 0.5$		%
U_{no}	RMS noise voltage referred to primary (DC ... 20 MHz)	< 40	mVpp
t_{D10}	Delay time to 10 % of the final output value for I_{PN} step	< 2	μs
t_{D90}	Delay time to 90 % of the final output value for I_{PN} step	< 3.5	μs
di/dt	di/dt accurately followed	> 100	A/ μs
BW	Frequency bandwidth (-3 dB) ³⁾	DC ... 240	kHz

- Notes:**
- 1) It is possible to overdrive U_{ref} with an external reference voltage between 0.5 - 2.65 V
 - 2) Excluding offset and magnetic offset voltage
 - 3) Small signal only to avoid excessive heatings of the magnetic core.

$$I_{PN} = 200 \dots 800\text{ A}$$

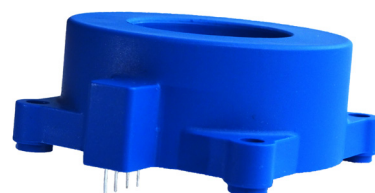

Features

- Hall effect measuring principle
- Galvanic separation between primary and secondary circuit
- Low power consumption
- Single power supply +5 V
- Ratiometric offset
- Insulating plastic case recognized according to UL 94-V0
- Fixation by M3 nuts and screws
- $T_A = -40^\circ\text{C} \dots +105^\circ\text{C}$.

Advantages

- Small size and space saving
- Only one design for wide current ratings range
- High immunity to external interference
- U_{ref} IN/OUT.

Applications

- Forklift drives
- AC variable speed drives
- Static converters for DC motor drives
- Battery supplied applications
- Uninterruptible Power Supplies (UPS)
- Switched Mode Power Supplies (SMPS)
- Power supplies for welding applications.

Application domain

- Industrial.

Current Transducer HTFS 200 ... 800-P

General data

T_A	Ambient operating temperature	-40 ... +105	°C
T_{Ast}	Ambient storage temperature	-40 ... +105	°C
m	Mass	60	g
	Standard	EN 50178: 1997	

Insulation coordination

U_d	RMS voltage for AC insulation test, 50 Hz, 1 min	2.5	kV
U_i	Partial discharge RMS test voltage ($q_m < 10$ pC)	> 1	kV
U_{Ni}	Impulse withstand voltage 1.2/50 μ s	4	kV
		Min	
d_{Cp}	Creepage distance	> 4	mm
d_{Cl}	Clearance distance	> 4	mm
CTI	Comparative Tracking Index (group IIIa)	> 220	

Applications examples

	EN 50178	IEC 61010-1
d_{Cp}, d_{Cl}, U_{Ni}	Rated insulation voltage	Nominal voltage
Basic insulation	300 V	300 V
Reinforced insulation	150 V	150 V

According to EN 50178 and IEC 61010-1 standards and following conditions:

- Over voltage category OV 3
- Pollution degree PD2
- Non-uniform field

Safety

This transducer must be used in limited-energy secondary circuits according to IEC 61010-1.



This transducer must be used in electric/electronic equipment with respect to applicable standards and safety requirements in accordance with the manufacturer's operating instructions.



Caution, risk of electrical shock

When operating the transducer, certain parts of the module can carry hazardous voltage (eg. primary busbar, power supply). Ignoring this warning can lead to injury and/or cause serious damage.

This transducer is a build-in device, whose conducting parts must be inaccessible after installation. A protective housing or additional shield could be used.

Main supply must be able to be disconnected.

HTFS measuring range with external U_{ref}

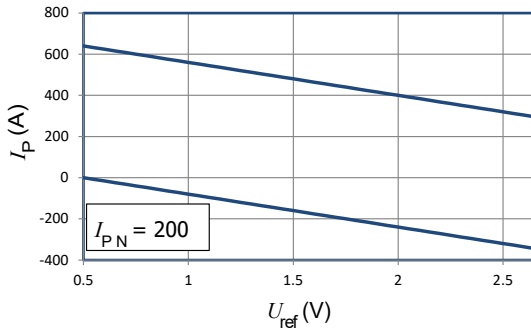

Upper limit: $I_p = -160 \times U_{ref} + 720$ ($U_{ref} = 0.5 \dots 2.65$ V)

Lower limit: $I_p = -160 \times U_{ref} + 80$ ($U_{ref} = 0.5 \dots 2.65$ V)

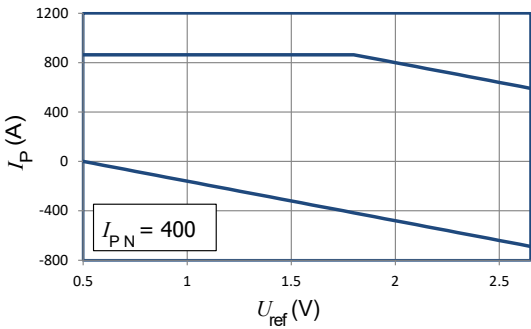

Upper limit: $I_p = 864$ ($U_{ref} = 0.5 \dots 1.8$ V)

Upper limit: $I_p = -320 \times U_{ref} + 1440$ ($U_{ref} = 1.8 \dots 2.65$ V)

Lower limit: $I_p = -320 \times U_{ref} + 160$ ($U_{ref} = 0.5 \dots 2.65$ V)

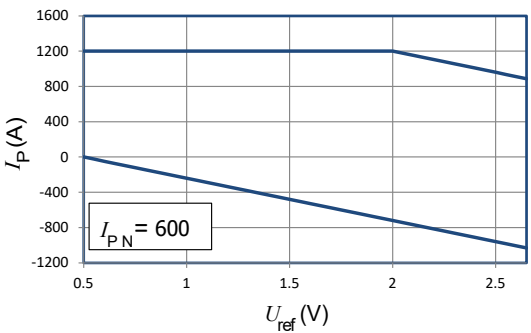

Upper limit: $I_p = 1200$ ($U_{ref} = 0.5 \dots 2.0$ V)

Upper limit: $I_p = -480 \times U_{ref} + 2160$ ($U_{ref} = 2 \dots 2.65$ V)

Lower limit: $I_p = -480 \times U_{ref} + 240$ ($U_{ref} = 0.5 \dots 2.65$ V)

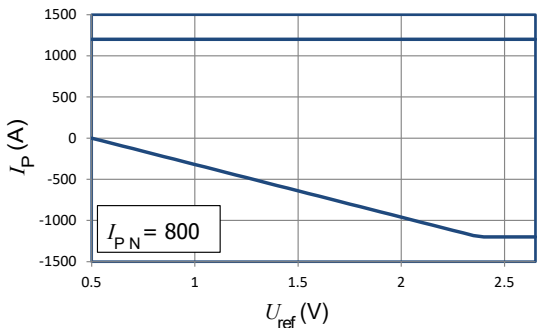

Upper limit: $I_p = 1200$ ($U_{ref} = 0.5 \dots 2.625$ V)

Upper limit: $I_p = -640 \times U_{ref} + 2880$ ($U_{ref} = 2.625 \dots 2.65$ V)

Lower limit: $I_p = -640 \times U_{ref} + 320$ ($U_{ref} = 0.5 \dots 2.4$ V)

Lower limit: $I_p = -1200$ ($U_{ref} = 2.4 \dots 2.65$ V)

Dimensions HTFS 200 ... 800-P (in mm)

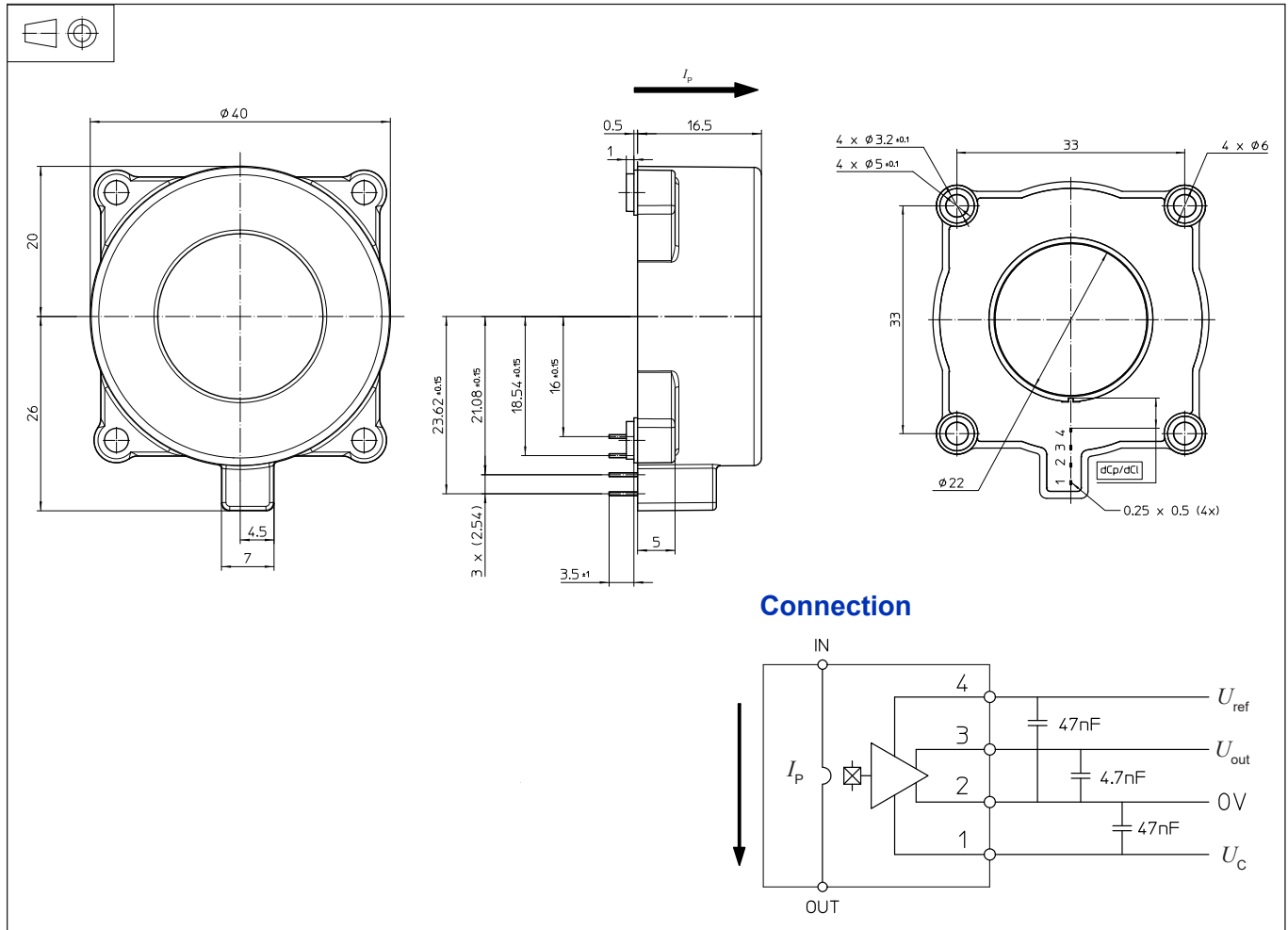

Mechanical characteristics



- General tolerance ± 0.2 mm
- Mounting to PCB
Recommended PCB hole $\varnothing 5.3$ mm
- Fastening torque 0.6 N·m
- Connection to secondary
Recommended PCB hole $\varnothing 0.7$ mm

Remarks



- U_{out} is positive when I_p flows in the direction of arrow.
- Temperature of the primary conductor should not exceed 120 °C.
- Must be mounted using PCB holes
- Installation of the transducer must be done, unless otherwise specified on the datasheet, according to LEM Transducer Generic Mounting Rules. Please refer to LEM document N°ANE120504 available on our Web site: <https://www.lem.com/en/file/3137/download/>

Looking for pricing, stock, or lifecycle information?

Click below to explore more details on WIN SOURCE:

-  [View HTFS200-P on WIN SOURCE](#)
-  [LEM USA Inc. Information](#)

Optimize Your Supply Chain with WIN SOURCE Solutions

-  Global Sourcing Solution
-  Obsolete Management
-  Cost Control Management
-  Shortage Management
-  Alternative Solution
-  Excess Inventory Management