

Features

- I EIA size:1812
- I Variable capacitance
- I Operating voltage: 18Vdc ~385Vdc
- I High surge suppress capability
- I Bidirectional and symmetrical V/I characteristics
- I Multilayer ceramic construction technology
- I RoHS & Halogen Free (HF) compliant
- I Operating temperature range: -55°C ~ +125°C
- I Storage temperature range: 5°C ~ +40°C



Applications

- I Used to Help Achieve Electromagnetic Compliance of End Products
- I Provides On-Board Transient Voltage Protection for ICs, CMOS and MOSFET
- I Suppression of Inductive Switching or Other Transient Events Such as EFT and Surge Voltage at the Circuit Board.
- I Protection of Components and Circuits Sensitive to ESD Transients Occurring on Power supplies, Control and Signal Lines.

Part Number Code

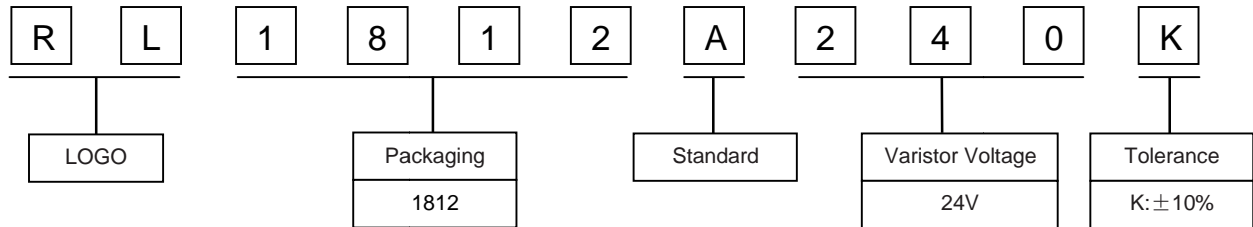

Electrical Characteristics

Type Number	Varistor Voltage	Max. Allowable Voltage		Max. Energy (10/1000µs)	Max. Clamping Voltage (8/20µs)		Withstanding Surge Current (8/20µs)
	V _{1mA} (V)	V _{AC} (V)	V _{DC} (V)	(J)	I _p (A)	V _c (V)	I(A)
RL1812A240K	21.6~27	14	18	1.5	10	59	500
RL1812A270K	26.4~33	17	22	1.5	10	72	800
RL1812A300K	28.8~36	18	24	1.5	10	79	800
RL1812A330K	31.2~39	19	26	1.5	10	85	800
RL1812A360K	33.6~42	21	28	1.5	10	92	800
RL1812A390K	36~45	25	30	1.5	10	99	800
RL1812A470K	45.6~57	30	38	1.5	10	125	800
RL1812A530K	50.4~63	32	42	1.5	10	138	800
RL1812A560K	54~67.5	35	45	1.5	10	148	800
RL1812A600K	57.6~72	37	48	1.5	10	158	800
RL1812A680K	67.2~84	40	56	1.5	10	184	800
RL1812A760K	72~90	43	60	1.5	10	198	800
RL1812A820K	78~97.5	46	65	1.5	10	214	800
RL1812A900K	81.6~102	49	68	1.5	10	224	800
RL1812A950K	90~112.5	54	75	1.5	10	247	800
RL1812A101K	102~127.5	60	85	1.5	10	280	800
RL1812A121K	108~132	65	90	1.5	10	290	800
RL1812A151K	135~165	75	110	1.5	10	340	500
RL1812A181K	162~198	115	150	2.3	10	360	400
RL1812A241K	216~264	150	200	2.3	10	415	400
RL1812A271K	243~297	175	225	2.3	10	475	400
RL1812A391K	351~429	250	320	2.3	10	650	400
RL1812A431K	387~473	275	350	2.3	10	710	400
RL1812A471K	423~517	300	385	2.3	10	775	400

Environmental Performance

Item	Specifications	Test Condition
Bias Humidity	V _V / V _V ±10%	90%RH, 40°C, Working Voltage, 1000 hrs
Thermal Shock	V _V / V _V ±10%	-40°C to 85°C,30min.cycle,5 cycles
Full Load Voltage	V _V / V _V ±10%	Working Voltage,85°C,1000 hrs

General Technical Data

Response Time	<1ns	
Solderability	245±5 °C, 3±1sec	
Solder leach resistance	260±5 °C,10±1sec	
Taping Package Storage Condition	Storage Temperature	5~40°C
	Relative Humidity	To 65%
	Storage Time	12 Months max



Soldering Parameters - Reflow Soldering (Surface Mount Devices)

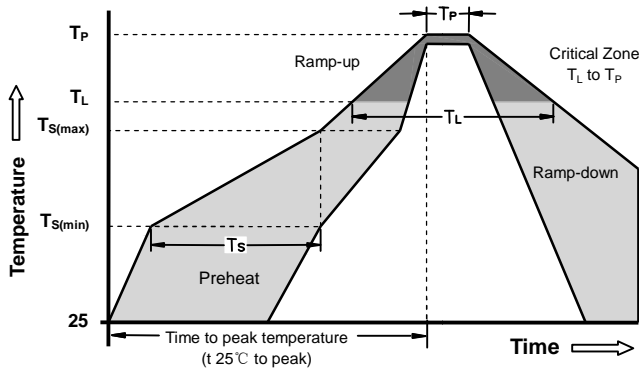

Reflow Condition		Pb - Free assembly
Pre Heat	-Temperature Min ($T_{s(min)}$)	150°C
	-Temperature Max ($T_{s(max)}$)	200°C
	- Time (min to max) (t_s)	60 -180 Seconds
Average ramp up rate (Liquids Temp T_L) to peak		3°C/second max
$T_{s(max)}$ to T_L - Ramp-up Rate		3°C/second max
Reflow	- Temperature (T_L) (Liquids)	217°C
	- Time (min to max) (t_s)	60 -150 Seconds
Peak Temperature (T_P)		260 +0/-5°C
Time within 5°C of actual peak Temperature (t_p)		20 - 40 Seconds
Ramp-down Rate		6°C/second max
Time 25°C to peak Temperature (T_P)		8 minutes Max
Do not exceed		260°C

Precaution for soldering

Note that this product will be easily damaged by rapid heating, rapid cooling or local heating.
Do not give heat shock over 100°C in the process of soldering. We recommend to take preheating and gradual cooling

Soldering gun procedure

Note the follows, in case of using solder gun for replacement.
1)The tip temperature must be less than 280 for the period within 3 seconds by using soldering gun under 30W
2) The soldering gun tip shall not touch this product directly.

Soldering volume

Note that excess of soldering volume will easily get crack the body of this product.

Dimensions And Recommended Pad Layout

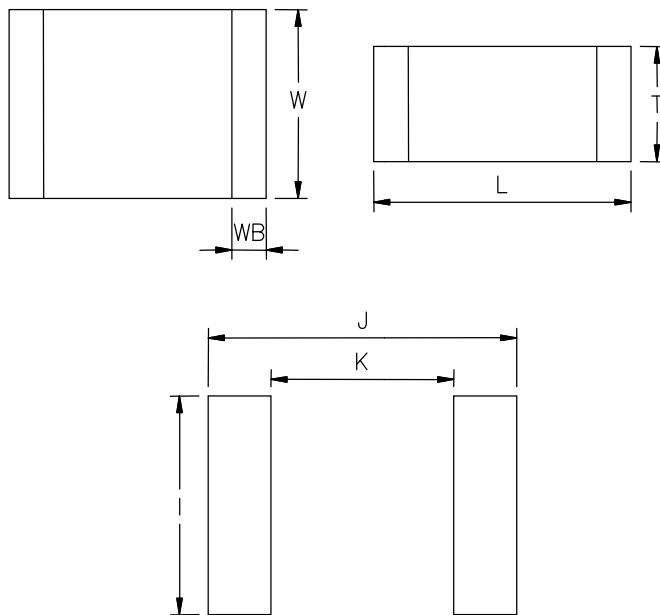

Recommended Soldering Pad Layout

Symbol	Millimeters	Inches
L	4.50±0.40	0.177±0.016
W	3.20±0.20	0.126±0.008
T_{max}	3.40	0.134
WB	0.60±0.25	0.024±0.01
I	3.7	0.146
J	5.4	0.213
K	3.2	0.126



Taping and Reel Specifications

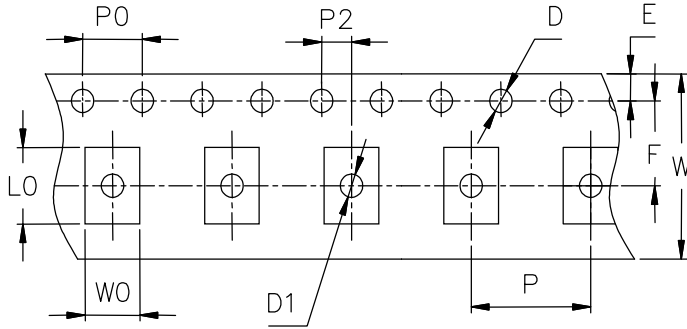

Symbol	Millimeters	Inches
W	12.00±0.20	0.472±0.008
E	1.75±0.10	0.069±0.004
F	5.50±0.05	0.217±0.002
D	1.55±0.05	0.061±0.002
D1	Φ1.50±0.05	Φ0.059±0.002
P	8.00±0.10	0.315±0.004
P0	4.00±0.05	0.157±0.002
P2	2.00±0.05	0.079±0.002
L0	5.45±0.10	0.215±0.004
W0	4.20±0.10	0.165±0.004

Packing Specifications

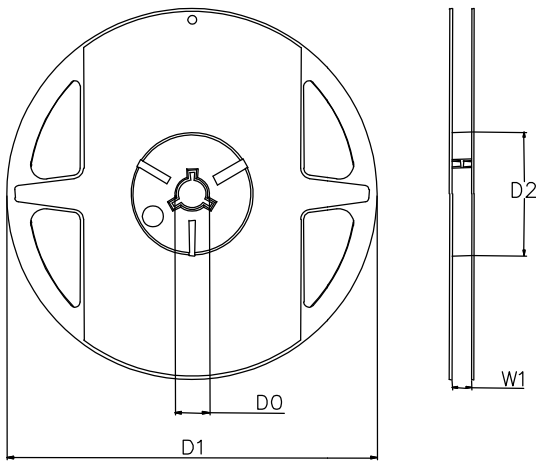

Symbol	Millimeters	Inches
D0	13.5±0.1	0.531±0.004
D1	178±2.0	7.008±0.079
D2	Φ60.0±0.5	Φ2.362±0.02
W1	13.08±0.2	0.515±0.008

Taping Specifications



There shall be the portion having no product in both the head and the end of taping, and there shall be the cover tape in the heat of taping.

Quantity of products in the taping package

SIZE EIA (EIAJ)	1812
Standard Packing Quantity (PCS/reel)	1000

Looking for pricing, stock, or lifecycle information?

Click below to explore more details on WIN SOURCE:

-  [View RL1812A390K on WIN SOURCE](#)
-  [Ruilongyuan Electronics Co.,Ltd Information](#)

Optimize Your Supply Chain with WIN SOURCE Solutions

-  Global Sourcing Solution
-  Obsolete Management
-  Cost Control Management
-  Shortage Management
-  Alternative Solution
-  Excess Inventory Management