

Features

- I Wide operating voltage (V_{1mA}) range from 18V to 1800V
- I Fast responding to transient over-voltage.
- I Large absorbing transient energy capability.
- I Low clamping ratio and no following-on current.



General Information

- I Surge protection in consumer electronics
- I Surge protection in industrial electronics
- I Relay and electromagnetic valve surge absorption
- I Transistor, diode, IC, thyristor or triac semiconductor protection
- I Surge protection in electronic home appliances, gas and petroleum appliances
- I Agency: CUL(E479668),CQC(22001337054), TUV(J50541477)



General Characteristics

- I Body: Nickel Plated
- I Devices with No Leads: Nickel Plated
- I Operating Temperature: -40°C to +85°C
- I Storage Temperature: -40 °C to +125°C
- I Axial Devices: Tin Plated

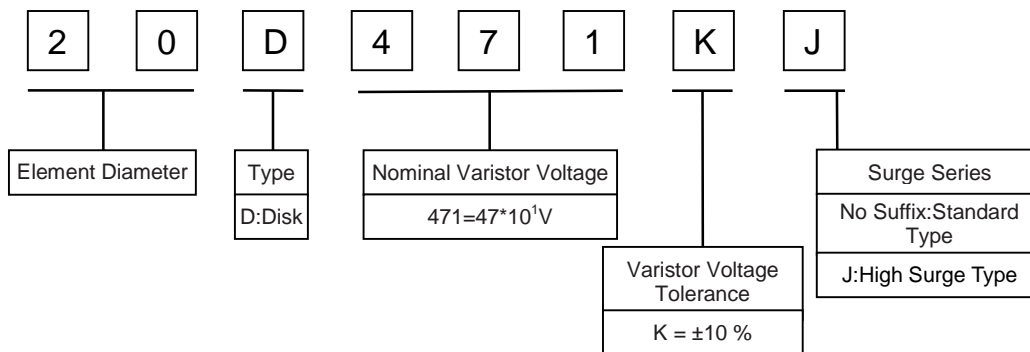
Part Number Code



Agency Information

Agency Information		Agency File Number
	CUL	E479668
	CQC	22001337054
	TUV	J50541477

Electrical Characteristics

Type Number		Varistor Voltage	Max. Allowable Voltage		Max. Energy (10/1000µs)		Max. Clamping Voltage (8/20µs)		Withstanding Surge Current (8/20µs)		Rated Power	Typical Capacitance (Reference)
Standard	High Surge	V _{1mA} (V)	V _{AC} (V)	V _{DC} (V)	(J) Standard	(J) High Surge	I _P (A)	V _C (V)	I(A) Standard	I(A) High Surge	(W)	@1KHz(pf)
20D180K	/	16~20	11	14	11	/	25	38	2000	/	0.2	39000
20D220K	/	20~24	14	18	14	/	25	43	2000	/	0.2	32000
20D270K	/	24.3~31.1	17	22	18	/	25	53	2000	/	0.2	22000
20D330K	/	29.7~37.9	20	26	23	/	25	65	2000	/	0.2	18000
20D390K	/	35.2~44.8	25	31	26	/	25	77	2000	/	0.2	16000
20D470K	/	43~53	30	38	33	/	25	93	2000	/	0.2	14000
20D560K	/	51~63	35	45	41	/	25	110	2000	/	0.2	12000
20D680K	/	62~76	40	56	46	/	25	135	2000	/	0.2	10000
20D820K	20D820KJ	74~90	50	65	48	67	100	135	6500	10000	1.0	5800
20D101K	20D101KJ	90~110	60	85	52	73	100	165	6500	10000	1.0	4800
20D121K	20D121KJ	108~132	75	100	56	78	100	200	6500	10000	1.0	3800
20D151K	20D151KJ	135~165	95	125	71	99	100	250	6500	10000	1.0	3000
20D181K	20D181KJ	162~198	115	150	86	152	100	300	6500	10000	1.0	2600
20D201K	20D201KJ	185~225	130	170	97	175	100	340	6500	10000	1.0	2400
20D221K	20D221KJ	198~242	140	180	102	185	100	360	6500	10000	1.0	1800
20D241K	20D241KJ	216~264	150	200	110	198	100	395	6500	10000	1.0	1500
20D271K	20D271KJ	243~297	175	225	130	220	100	455	6500	10000	1.0	1400
20D301K	20D301KJ	270~330	195	250	139	245	100	505	6500	10000	1.0	1350
20D331K	20D331KJ	297~363	210	275	153	268	100	550	6500	10000	1.0	1300
20D361K	20D361KJ	324~396	230	300	166	315	100	595	6500	10000	1.0	1250
20D391K	20D391KJ	351~429	250	320	184	350	100	650	6500	10000	1.0	1180
20D431K	20D431KJ	387~473	275	350	194	380	100	710	6500	10000	1.0	1100
20D471K	20D471KJ	423~517	300	385	224	405	100	775	6500	10000	1.0	1050
20D511K	20D511KJ	459~561	320	418	224	445	100	842	6500	10000	1.0	1000
20D561K	20D561KJ	504~616	350	460	224	475	100	920	6500	10000	1.0	970
20D621K	20D621KJ	558~682	385	505	224	490	100	1025	6500	10000	1.0	950
20D681K	20D681KJ	612~748	420	560	235	500	100	1120	6500	10000	1.0	900
20D751K	20D751KJ	675~825	460	615	260	525	100	1240	6500	10000	1.0	850
20D781K	20D781KJ	702~858	485	640	269	530	100	1290	6500	10000	1.0	750
20D821K	20D821KJ	738~902	510	670	288	545	100	1355	6500	10000	1.0	700
20D911K	20D911KJ	819~1001	550	745	316	595	100	1500	6500	10000	1.0	600
20D951K	20D951KJ	855~1045	580	780	328	610	100	1570	6500	10000	1.0	580
20D102K	20D102KJ	900~1100	625	825	349	650	100	1650	6500	10000	1.0	500
20D112K	20D112KJ	990~1210	680	895	391	720	100	1815	6500	10000	1.0	450
20D122K	20D122KJ	1080~1320	740	975	425	730	100	2010	6500	10000	1.0	440
20D142K	20D142KJ	1260~1540	870	1150	481	750	100	2310	6500	10000	1.0	410
20D152K	20D152KJ	1350~1650	900	1220	516	790	100	2475	6500	10000	1.0	400
20D182K	20D182KJ	1620~1980	1000	1465	632	850	100	2970	6500	10000	1.0	220

Electrical Ratings

Items	Test Condition/Description	Requirement					
Varistor Voltage	The voltage between two terminals with the specified measuring current 1mA.DC applied is called Vb.						
Maximum Allowable Voltage	The recommended maximum sine wave voltage (RMS) or the Maximum DC voltage can be applied continuously.						
Maximum Clamping Voltage	<p>The maximum voltage between two terminals with the specification standard impulse current. Applied waveform: 8/20μs</p> <p style="text-align: center;"> $T_1=1.25 \cdot T=8\mu s \pm 20\%$ $T_2=20\mu s \pm 20\%$ </p>		To meet the Specified value				
Rated Wattage	The maximum average power that can be applied within the specified ambient temperature.						
Energy	The maximum energy within the varistor voltage change of $\pm 10\%$ when one impulse of 10/1000μs or 2ms is applied.						
Withstanding Surge Current	The maximum current within the varistor voltage change of $\pm 10\%$ with the standard impulse current (8/20μs) applied one time.						
Surge Life	<p>The change of Vb shall be measured after the impulse listed below which is applied 10,000 times continuously with the interval of ten seconds at room temperature.</p> <table border="1" style="margin-left: auto; margin-right: auto;"> <tr> <td rowspan="2" style="text-align: center;">20Φ series</td> <td style="text-align: center;">180K to 680K</td> <td style="text-align: center;">100A (8/20μs)</td> </tr> <tr> <td style="text-align: center;">820K to 182K</td> <td style="text-align: center;">200A (8/20μs)</td> </tr> </table>	20Φ series	180K to 680K	100A (8/20μs)	820K to 182K	200A (8/20μs)	$\frac{\Delta V_b}{V_b} \leq \pm 10\%$
20Φ series	180K to 680K		100A (8/20μs)				
	820K to 182K	200A (8/20μs)					

Soldering Recommendation

Wave Lead Free Soldering Recommendation

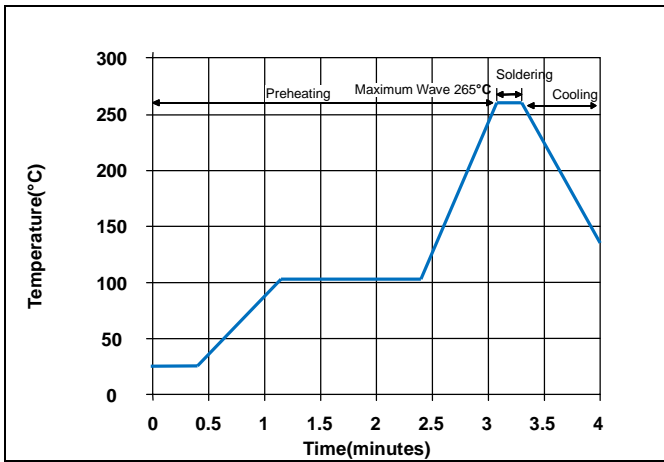

Item	Conditions
Peak Temperature	265°C
Dipping Time	10 seconds (max.)
Soldering	1 time

Recommendation Reworking Conditions with Soldering Iron

Item	Conditions
Temperature of Soldering Iron-tip	360°C (max.)
Soldering Time	3 seconds (max.)
Distance from Varistor	2mm (min.)

Dimensions

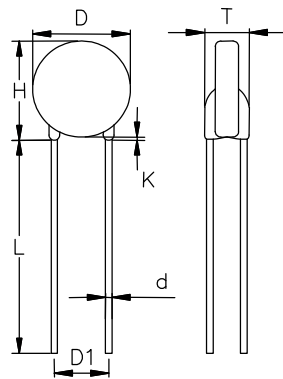

Symbol	Millimeter	Inches
H(max)	26.0	1.024
L(min)	15.0	0.591
D(max)	23.0	0.906
D1(±1.0)	10.0	0.394
K(max)	2.0	0.079
T(max)	TABLE 2	
d(±0.1)	1.0	0.039

Packaging Quantity: 250pcs/bag

TABLE 2---T(max.)

Model	Millimeters	Inches	Model	Millimeters	Inches
18V~39V	5.1	0.201	430V~560V	6.7	0.264
47V~68V	5.6	0.220	620V~780V	7.7	0.303
82V~150V	5.1	0.201	820V~1200V	8.9	0.350
180V~270V	5.7	0.224	1300V~1500V	10	0.394
330V~390V	6.1	0.240	1600V~1800V	11.8	0.465

Taping Dimensions

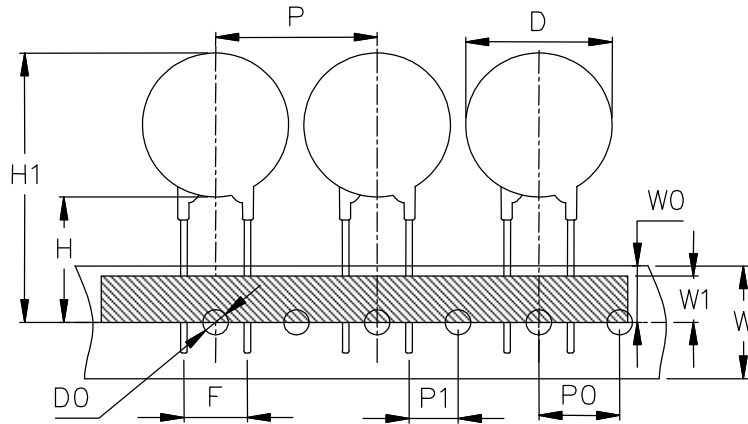

Symbol	Millimeters	Inches
W	18±1.0	0.709±0.039
W0(max.)	9.0	0.354
W1	8.0±0.5	0.315±0.02
P	25.4±1.0	1.0±0.039
P0	12.7±1.0	0.50±0.039
P1	7.7±0.7	0.303±0.028
F	10.0±1.0	0.39±0.039
D0	4.0±0.3	0.157±0.012
H	20.0±1.3	0.787±0.051
H1(max.)	45.0	1.772
Packaging Quantity	180K~301K	500pcs/reel
	331K~122K	250pcs/reel

Looking for pricing, stock, or lifecycle information?

Click below to explore more details on WIN SOURCE:

- [View 20D471KJ on WIN SOURCE](#)
- [Ruilongyuan Electronics Co.,Ltd Information](#)

Optimize Your Supply Chain with WIN SOURCE Solutions

- ✓ Global Sourcing Solution
- ✓ Obsolete Management
- ✓ Cost Control Management
- ✓ Shortage Management
- ✓ Alternative Solution
- ✓ Excess Inventory Management