

Zenamic (Metal Oxide Varistor)

METAL OXIDE VARISTOR

ZENAMIC

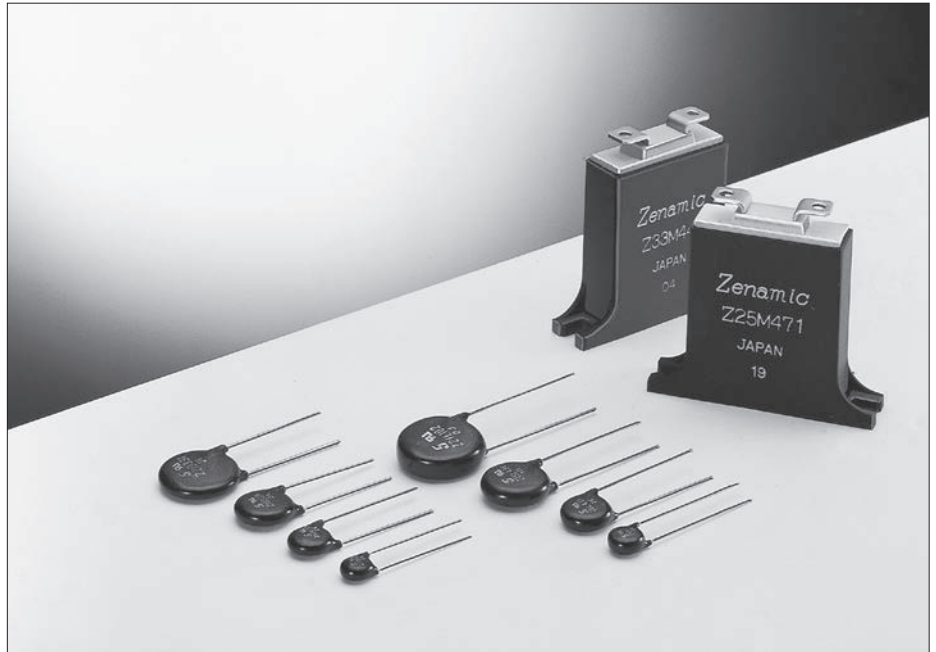

Zenamic is the registered trademark for our oxidized metal varistors. Zenamic features large surge current handling ability and transient overvoltage handling capability. Zenamic is produced by sintering a ZnO based mineral mix at temperatures of 1200 to 1400°C.

Applications

- Semiconductor protection: Diodes, transistors, thyristors, IC etc.
- Home electronics protection: TVs, air conditioners, refrigerators, microwave ovens etc.
- Office automation device protection: PPC copy machines, fax machines, PCs etc.
- Industrial device protection: Robots, boilers, machine tooling etc.
- Inrush surge protection: Electromagnetic clutch / break devices, relay control devices, short circuit breakers etc.
- Others: Automotive electrification, vending machines, communication / broadcasting devices etc.

V-I characteristics

ZENAMIC has the forward-reverse symmetrical characteristics as shown in figure 1. The voltage-current curves show the varistor characteristics for the range of 1 μA to 104 A, and show the resistance characteristics for the values below 1 μA and above 104 A in figure 2. The voltage across terminals when a test current (It: 1 mA) is applied to ZENAMIC is the standard varistor voltage (Vz), and the voltage across terminals when a standard surge (Ip) is applied represents the maximum suppression voltage (Vc).

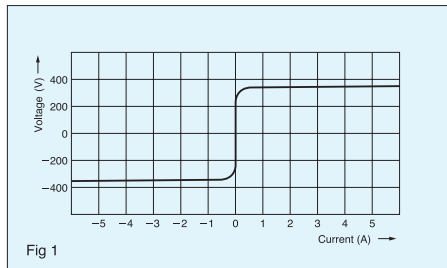

Fig 1

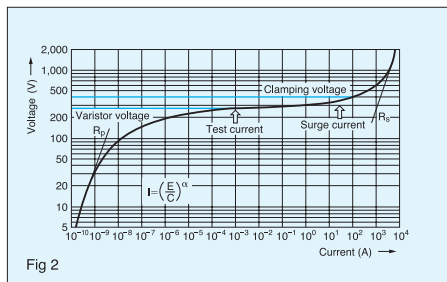

Fig 2

Temperature characteristics

For low current values ZENAMIC features outstanding temperature characteristics. The shunt resistance Rp of the metal oxide varistor has temperature characteristics which are determined by the following equation.

$$R_P = A e^{-E_g / 2kT} \quad (2)$$

T: Absolute temperature
k: Boltzmann constant
A, Eg: constants

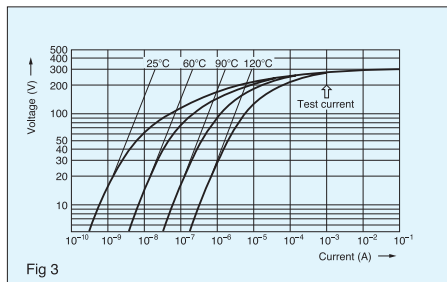

Fig 3

Temperature dependence characteristics for low current values.

The surge waveform

The surge waveform varies according to the sources. An EXP waveform is used for surge testing of ZENAMIC, while a AC half-wave is used for the energy absorption test. The EXP waveform reaches its peak voltage (current) at [ta] as shown in figure 5, and then decreases as time passes and reaches half of the peak voltage (current) at [tb]. This type of the EXP waveform is shown as a [ta/tb] voltage (current) waveform. For surge testing of ZENAMIC, a 8/20μ. sec current waveform is used.

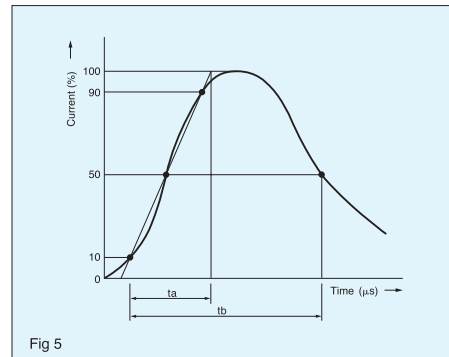
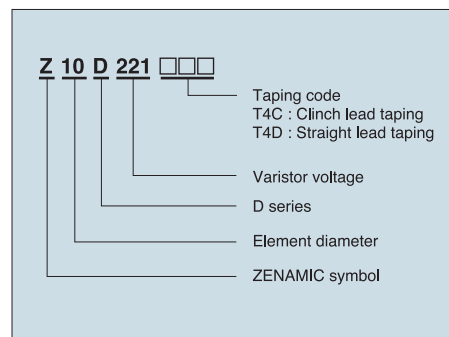

Fig 5

Part Number



Application notes (general)

A surge in excess of the specified maximum peak current may cause a short circuit or mechanical damage. The following measures are recommended.

- If ZENAMIC is used in line to ground, the ground fault circuit interrupter should be applied in location A or, alternatively, a thermally coupled fuse should be applied in location C.
- ZENAMIC should not be used near heat generating devices and not be subjected to direct sunlight.
- ZENAMIC should not be used near flammable materials.

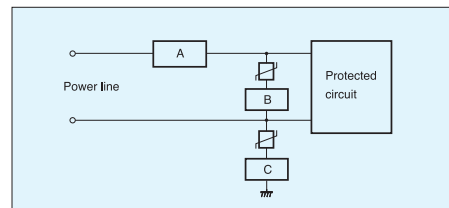

- 1) The location of the over current protector (circuit breaker or current fuse) should be in the power line to the circuit (location A) or in series with ZENAMIC (location B).
- 2) It is recommended that a fuse similar to the ones listed in the table below be put in location A or B.

- 3) If ZENAMIC is used in line to ground, the ground fault circuit interrupter should be applied in location A or, alternatively, a thermally coupled fuse should be applied in location C.

Part Number	Z7D□□□	Z10D□□□
Rating of fuse	5A max.	7A max.

Part Number	Z15D□□□	Z21D□□□
Rating of fuse	10A max.	15A max.

Please also consult the related safety standards.

Example circuits

Example circuits with power lines and surge absorption unit locations.

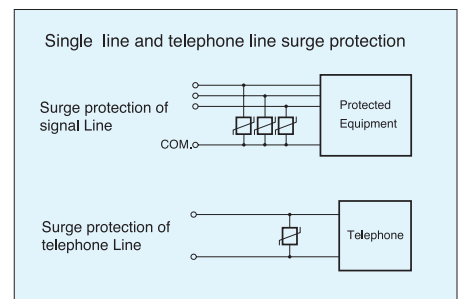
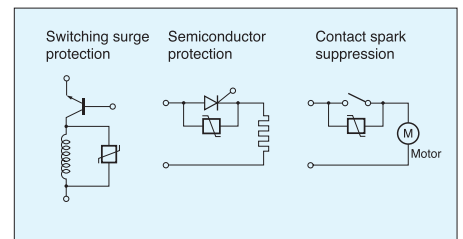
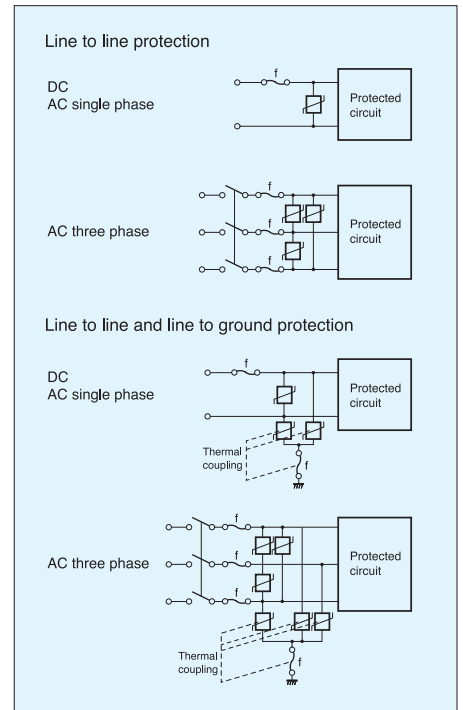

Z7D Series

Specifications

Part No.	Varistor voltage	Maximum allowable voltage		Clamping voltage (max.)	Rated power	Maximum energy		Maximum peak current (8/20 μ s) 2 times	Capacitance (TYP) 1kHz
		V _{1mA} (V)	AC _{rms} (V)			DC(V)	V(V)		
Z7D180	18(16-20)	11	14	36 at 2.5A	0.02	1.1	0.9	250	3800
Z7D220	22(20-24)	14	18	43		1.3	1.1		3600
Z7D270	27(24-30)	17	22	53		1.6	1.3		3400
Z7D330	33(30-36)	20	26	65		2.0	1.6		2900
Z7D390	39(35-43)	25	31	77		2.4	1.9		1600
Z7D470	47(42-52)	30	38	93		2.8	2.3		1550
Z7D560	56(50-62)	35	45	110		3.4	2.7		1500
Z7D680	68(61-75)	40	56	135		4.1	3.3		1200
Z7D820 ¹	82(74-90)	50	65	135 at 10A		7	5		810
Z7D101 ¹	100(90-110)	60	85	165		8.5	6		700
Z7D121 ¹	120(108-132)	75	100	200	10	7	590		
Z7D151 ¹	150(135-165)	95	125	250	13	9	500		
Z7D201 ¹	200(185-225)	130	170	340	17.5	12.5	200		
Z7D221 ¹	220(198-242)	140	180	360	19	13.5	190		
Z7D241 ¹	240(216-264)	150	200	395	21	15	170		
Z7D271 ¹	270(247-303)	175	225	455	24	17	150		
Z7D331 ¹	330(297-363)	210	270	545	28	20	130		
Z7D361 ¹	360(324-396)	230	300	595	32	23	130		
Z7D391 ¹	390(351-429)	250	320	650	35	25	130		
Z7D431 ¹	430(387-473)	275	350	710	40	27.5	120		
Z7D471 ¹	470(423-517)	300	385	775	42	30	100 ²		
Z7D511 ¹	510(459-561)	320	410	845	45	32	90 ²		

Operating temperature range: -40 to 85°C

Storage temperature range: -40 to 125°C

¹ UL 1449 approved model

² Measured at 1MHz

Z10D Series

Specifications

Part No.	Varistor voltage	Maximum allowable voltage		Clamping voltage (max.)	Rated power	Maximum energy		Maximum peak current (8/20 μ s) 2 times	Capacitance (TYP) 1kHz
		V _{1mA} (V)	AC _{rms} (V)			DC(V)	V(V)		
Z10D180	18(16-20)	11	14	36 at 5A	0.05	2.6	2.2	500	16000
Z10D220	22(20-24)	14	18	43		3.2	2.6		11000
Z10D270	27(24-30)	17	22	53		3.9	3.2		8000
Z10D330	33(30-36)	20	26	65		4.8	4.0		6300
Z10D390	39(35-43)	25	31	77		5.6	4.7		5200
Z10D470	47(42-52)	30	38	93		6.8	5.6		4600
Z10D560	56(50-62)	35	45	110		8.1	6.7		3750
Z10D680	68(61-75)	40	56	135		9.8	8.2		2800
Z10D820 ¹	82(74-90)	50	65	135 at 25A		14	10		2000
Z10D101 ¹	100(90-110)	60	85	165		17	12		1700
Z10D121 ¹	120(108-132)	75	100	200	20	14.5	1400		
Z10D151 ¹	150(135-165)	95	125	250	25	18	1100		
Z10D201 ¹	200(185-225)	130	170	340	35	25	430		
Z10D221 ¹	220(198-242)	140	180	360	39	27.5	410		
Z10D241 ¹	240(216-264)	150	200	395	42	30	380		
Z10D271 ¹	270(247-303)	175	225	455	49	35	350		
Z10D331 ¹	330(297-363)	210	270	545	58	42	300		
Z10D361 ¹	360(324-396)	230	300	595	65	45	300		
Z10D391 ¹	390(351-429)	250	320	650	70	50	300		
Z10D431 ¹	430(387-473)	275	350	710	80	55	270		
Z10D471 ¹	470(423-517)	300	385	775	85	60	230		
Z10D511 ¹	510(459-561)	320	410	845	92	67	210		
Z10D561 ¹	560(504-616)	350	450	930	92	67	200		
Z10D681 ¹	680(612-748)	420	560	1120	92	67	170		
Z10D751 ¹	750(675-825)	460	615	1240	100	70	160		
Z10D821 ¹	820(738-902)	510	670	1355	110	80	140		
Z10D911 ¹	910(819-1001)	550	745	1500	130	90	120		
Z10D102 ¹	1000(900-1100)	625	825	1650	140	100	110		

Operating temperature range: -40 to 85°C

Storage temperature range: -40 to 125°C

¹ UL 1449 approved model

Z15D Series

Specifications

Part No.	Varistor voltage	Maximum allowable voltage		Clamping voltage (max.)	Rated power	Maximum energy		Maximum peak current (8/20 μ s) 2 times	Capacitance (TYP) 1kHz
		V _{1mA} (V)	AC _{rms} (V)			DC(V)	V(V)		
Z15D180	18(16-20)	11	14	36 at 10A	0.1	5.2	4.3	1000	25000
Z15D220	22(20-24)	14	18	43		6.3	5.3		20000
Z15D270	27(24-30)	17	22	53		7.8	6.5		16000
Z15D330	33(30-36)	20	26	65		9.5	7.9		12200
Z15D390	39(35-43)	25	31	77		11	9.4		7000
Z15D470	47(42-52)	30	38	93		14	11		6750
Z15D560	56(50-62)	35	45	110		16	13		6500
Z15D680	68(61-75)	40	56	135		20	16		5500
Z15D820 ¹	82(74-90)	50	65	135 at 50A		28	20		3700
Z15D101 ¹	100(90-110)	60	85	165		35	25		3200
Z15D121 ¹	120(108-132)	75	100	200	42	30	2700		
Z15D151 ¹	150(135-165)	95	125	250	53	37.5	2200		
Z15D201 ¹	200(185-225)	130	170	340	70	50	770		
Z15D221 ¹	220(198-242)	140	180	360	78	55	740		
Z15D241 ¹	240(216-264)	150	200	395	84	60	700		
Z15D271 ¹	270(247-303)	175	225	455	99	70	640		
Z15D331 ¹	330(297-363)	210	270	545	115	80	580		
Z15D361 ¹	360(324-396)	230	300	595	130	90	540		
Z15D391 ¹	390(351-429)	250	320	650	140	100	500		
Z15D431 ¹	430(387-473)	275	350	710	155	110	450		
Z15D471 ¹	470(423-517)	300	385	775	175	125	400		
Z15D511 ¹	510(459-561)	320	410	845	190	136	350		
Z15D561 ¹	560(504-616)	350	450	930	190	136	340		
Z15D681 ¹	680(612-748)	420	560	1120	190	136	320		
Z15D751 ¹	750(675-825)	460	615	1240	210	150	310		
Z15D821 ¹	820(738-902)	510	670	1355	235	165	280		
Z15D911 ¹	910(819-1001)	550	745	1500	255	180	250		
Z15D102 ¹	1000(900-1100)	625	825	1650	280	200	230		

Operating temperature range: -40 to 85°C
Storage temperature range: -40 to 125°C

¹ UL 1449 approved model

Z21D Series

Specifications

Part No.	Varistor voltage	Maximum allowable voltage		Clamping voltage (max.)	Rated power	Maximum energy		Maximum peak current (8/20 μ s) 2 times	Capacitance (TYP) 1kHz
		V _{1mA} (V)	AC _{rms} (V)			DC(V)	V(V)		
Z21D180	18(16-20)	11	14	36 at 20A	0.2	13	12	2000	40000
Z21D220	22(20-24)	14	18	43		16	14		30000
Z21D270	27(24-30)	17	22	53		19	17		24500
Z21D330	33(30-36)	20	26	65		24	21		20000
Z21D390	39(35-43)	25	31	77		28	25		13800
Z21D470	47(42-52)	30	38	93		34	30		13500
Z21D560	56(50-62)	35	45	110		41	36		12200
Z21D680	68(61-75)	40	56	135		49	44		11500
Z21D820 ¹	82(74-90)	50	65	135 at 100A		56	40		7500
Z21D101 ¹	100(90-110)	60	85	165		70	50		6500
Z21D121 ¹	120(108-132)	75	100	200	85	60	5500		
Z21D151 ¹	150(135-165)	95	125	250	106	75	4500		
Z21D201 ¹	200(185-225)	130	170	340	140	100	1700		
Z21D221 ¹	220(198-242)	140	180	360	155	110	1600		
Z21D241 ¹	240(216-264)	150	200	395	168	120	1500		
Z21D271 ¹	270(247-303)	175	225	455	190	135	1300		
Z21D331 ¹	330(297-363)	210	270	545	228	160	1100		
Z21D361 ¹	360(324-396)	230	300	595	255	180	1100		
Z21D391 ¹	390(351-429)	250	320	650	275	195	1100		
Z21D431 ¹	430(387-473)	275	350	710	303	215	1000		
Z21D471 ¹	470(423-517)	300	385	775	350	250	900		
Z21D511 ¹	510(459-561)	320	410	845	382	273	800		
Z21D561 ¹	560(504-616)	350	450	930	382	273	750		
Z21D681 ¹	680(612-748)	420	560	1120	382	273	650		
Z21D751 ¹	750(675-825)	460	615	1240	420	300	600		
Z21D821 ¹	820(738-902)	510	670	1355	460	325	530		
Z21D911 ¹	910(819-1001)	550	745	1500	510	360	500		
Z21D102 ¹	1000(900-1100)	625	825	1650	565	400	450		

Operating temperature range: -40 to 85°C
Storage temperature range: -40 to 125°C

¹ UL 1449 approved model

Dimensions

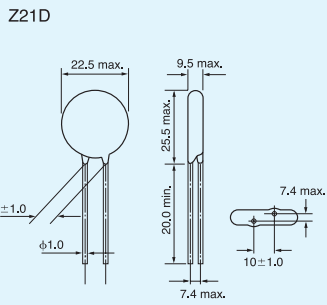
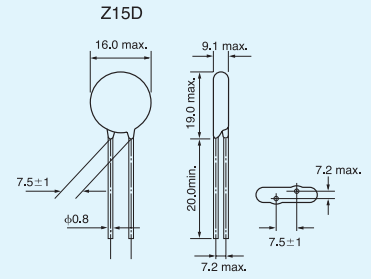
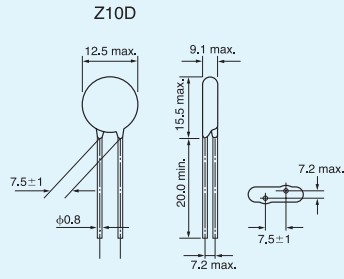
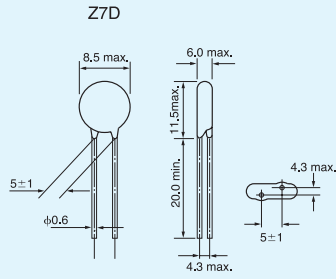

Crimped leads + taping
Z7D□□□ T4C

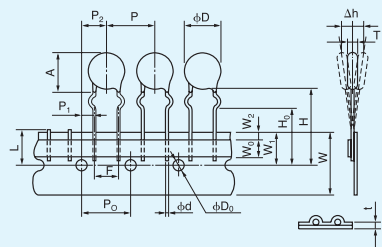

Straight leads + taping
Z7D□□□ T4D

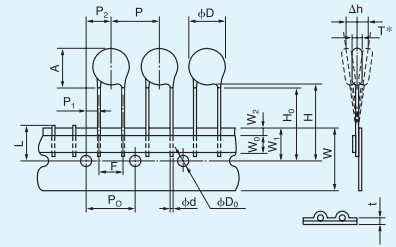

'Dimension "T" changes for each individual part specification.
Packing quantity: 1000 pcs/box

Symbol	Type I
P	12.7±1.0
P ₀	12.7±0.3
P ₁	3.85±0.70
P ₂	6.35±1.30
φd	0.60 ^{+0.06} _{-0.05}
F	5.0±0.5
Δh	0±2
W	18.0 ^{+1.0} _{-0.5}
φD	Z7D: 8.5max

Symbol	Type I
W ₀	5.0min
W ₁	9.0±0.5
W ₂	3max
H	Approx. 22
H ₀	17.0±0.5
φD ₀	φ4.0±0.2
t	0.6±0.3
L	11max

'Dimension "T" changes for each individual part specification.
Packing quantity: 1000 pcs/box



P	12.7±1.0
P ₀	12.7±0.3
P ₁	3.85±0.70
P ₂	6.35±1.30
φd	0.60 ^{+0.06} _{-0.05}
F	5.0±0.5
Δh	0±2
W	18.0 ^{+1.0} _{-0.5}

W ₀	5.0min
W ₁	9.0±0.5
W ₂	3max
H	Approx. 20
H ₀	17.0±0.5
φD ₀	φ4.0±0.2
t	0.6±0.3
L	11max
φD	Z7D: 8.5max







Unit (mm)

Looking for pricing, stock, or lifecycle information?

Click below to explore more details on WIN SOURCE:

-  [View Z15D151 on WIN SOURCE](#)
-  [Samtec Inc. Information](#)

Optimize Your Supply Chain with WIN SOURCE Solutions

-  Global Sourcing Solution
-  Obsolete Management
-  Cost Control Management
-  Shortage Management
-  Alternative Solution
-  Excess Inventory Management