



SIOV metal oxide varistors

Leaded varistors, SuperioR, S20 series

Series/Type: S20

Date: December 2007

Leaded varistors

SuperioR, S20 series

Construction

- Round varistor element, leaded
- Coating: epoxy resin, flame-retardant to UL 94 V-0
- Terminals: tinned copper wire

Features

- High-energy SuperioR series E3
- Very high surge current ratings of 12 kA
- High energy ratings up to 320 J
- PSpice models

Approvals

- UL
- CSA
- CECC
- VDE
- IEC

Delivery mode

- Bulk (standard), taped versions on reel or in Ammo pack upon request.
- For further details refer to chapter "Taping, packaging and lead configuration" for leaded varistors.

General technical data

Climatic category	to IEC 60068-1	40/85/56	
Operating temperature	to CECC 42 000	-40 ... + 85	°C
Storage temperature		-40 ... +125	°C
Electric strength	to CECC 42 000	≥2.5	kV _{RMS}
Insulation resistance	to CECC 42 000	≥10	MΩ
Response time		<25	ns

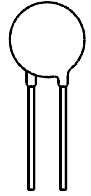
Leaded varistors
SuperioR, S20 series
Maximum ratings ($T_A = 85\text{ °C}$)

Ordering code	Type (untaped) SIOV-	V_{RMS} V	V_{DC} V	i_{max} (8/20 μ s) A	W_{max} (2 ms) J	P_{max} W
B72220S3111K101	S20K115E3	115	150	12000	110	1.0
B72220S3131K101	S20K130E3	130	170	12000	130	1.0
B72220S3141K101	S20K140E3	140	180	12000	140	1.0
B72220S3151K101	S20K150E3	150	200	12000	150	1.0
B72220S3171K101	S20K175E3	175	225	12000	180	1.0
B72220S3211K101	S20K210E3	210	270	12000	210	1.0
B72220S3231K101	S20K230E3	230	300	12000	220	1.0
B72220S3251K101	S20K250E3	250	320	12000	250	1.0
B72220S3271K101	S20K275E3	275	350	12000	260	1.0
B72220S3301K101	S20K300E3	300	385	12000	290	1.0
B72220S3321K101	S20K320E3	320	420	12000	320	1.0

Characteristics ($T_A = 25\text{ °C}$)

Ordering code	Type (untaped) SIOV-	V_V (1 mA) V	ΔV_V (1 mA) %	$V_{c, max}$ (i_c) V	i_c A	C_{typ} (1 kHz) pF
B72220S3111K101	S20K115E3	180	± 10	300	100	1520
B72220S3131K101	S20K130E3	205	± 10	340	100	1340
B72220S3141K101	S20K140E3	220	± 10	360	100	1240
B72220S3151K101	S20K150E3	240	± 10	395	100	1160
B72220S3171K101	S20K175E3	270	± 10	455	100	1000
B72220S3211K101	S20K210E3	330	± 10	550	100	830
B72220S3231K101	S20K230E3	360	± 10	595	100	760
B72220S3251K101	S20K250E3	390	± 10	650	100	700
B72220S3271K101	S20K275E3	430	± 10	710	100	630
B72220S3301K101	S20K300E3	470	± 10	775	100	580
B72220S3321K101	S20K320E3	510	± 10	840	100	540

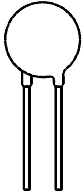

Leaded varistors
SuperioR, S20 series

Dimensional drawing

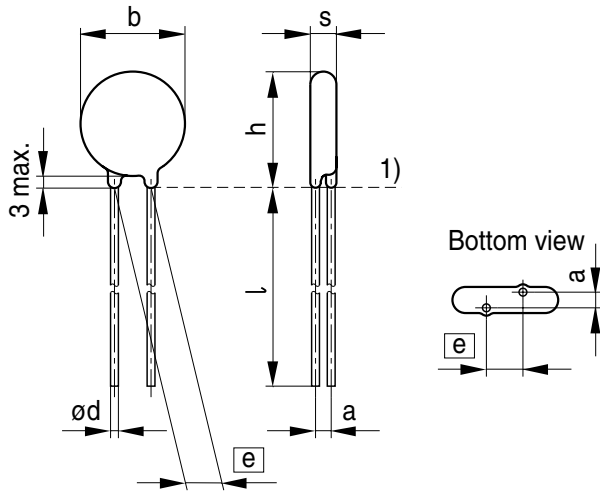

1) Seating plane to IEC 60717

VAR0408-C

Weight

Nominal diameter mm	V_{RMS} V	Weight g
20	115 ... 320	4.0 ... 7.0

The weight of varistors in between these voltage classes can be interpolated.

Dimensions

Ordering code	$e \pm 1$ mm	$a \pm 1$ mm	b_{max} mm	s_{max} mm	h_{max} mm	l_{min} mm	$d \pm 0.05$ mm
B72220S3111K101	10.0	1.8	22.5	4.8	26.0	25.0	1.0
B72220S3131K101	10.0	2.0	22.5	5.0	26.0	25.0	1.0
B72220S3141K101	10.0	2.1	22.5	5.1	26.0	25.0	1.0
B72220S3151K101	10.0	2.2	22.5	5.2	26.0	25.0	1.0
B72220S3171K101	10.0	2.3	22.5	5.3	26.0	25.0	1.0
B72220S3211K101	10.0	2.4	22.5	5.4	26.0	25.0	1.0
B72220S3231K101	10.0	2.9	22.5	5.9	26.0	25.0	1.0
B72220S3251K101	10.0	3.1	22.5	6.1	27.0	25.0	1.0
B72220S3271K101	10.0	3.3	22.5	6.3	27.0	25.0	1.0
B72220S3301K101	10.0	3.6	22.5	6.6	27.0	25.0	1.0
B72220S3321K101	10.0	3.8	22.5	6.8	27.0	25.0	1.0

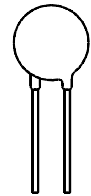
Reliability data

Test	Test methods/conditions	Requirement
Varistor voltage	The voltage between two terminals with the specified measuring current applied is called V_V (1 mA _{DC} @ 0.2 ... 2 s).	To meet the specified value.
Clamping voltage	The maximum voltage between two terminals with the specified standard impulse current (8/20 μ s) applied.	To meet the specified value.
Max. AC operating voltage	CECC 42 000, test 4.20 1000 h at UCT After having continuously applied the maximum allowable voltage at UCT ± 2 °C for 1000 h, the specimen shall be stored at room temperature and normal humidity for 1 to 2 h. Thereafter, the change of V_V shall be measured.	$ \Delta V/V (1 \text{ mA}) \leq 10\%$
Surge current derating, 8/20 μ s	CECC 42 000, test C 2.1 100 surge currents (8/20 μ s), unipolar, interval 30 s, amplitude corresponding to derating curve for 100 impulses at 20 μ s	$ \Delta V/V (1 \text{ mA}) \leq 10\%$ (measured in direction of surge current) No visible damage
Surge current derating, 2 ms	CECC 42 000, test C 2.1 100 surge currents (2 ms), unipolar, interval 120 s, amplitude corresponding to derating curve for 100 impulses at 2 ms	$ \Delta V/V (1 \text{ mA}) \leq 10\%$ (measured in direction of surge current) No visible damage
Electric strength	CECC 42 000, test 4.7 Metal balls method, 2500 V _{RMS} , 60 s The varistor is placed in a container holding 1.6 \pm 0.2 mm diameter metal balls such that only the terminations of the varistor are protruding. The specified voltage shall be applied between both terminals of the specimen connected together and the electrode inserted between the metal balls.	No breakdown

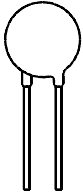

Leaded varistors

Superior, S20 series

Reliability data

Test	Test methods/conditions	Requirement
Climatic sequence	<p>CECC 42 000, test 4.16</p> <p>The specimen shall be subjected to:</p> <p>a) dry heat at UCT, 16 h</p> <p>b) damp heat, 1st cycle: 55 °C, 93% r. H., 24 h</p> <p>c) cold, LCT, 2 h</p> <p>d) damp heat, additional 5 cycles: 55 °C/25 °C, 93% r. H., 24 h/cycle.</p> <p>Then the specimen shall be stored at room temperature and normal humidity for 1 to 2 h.</p> <p>Thereafter, the change of V_v shall be measured. Thereafter, insulation resistance R_{ins} shall be measured according to CECC 42 000, test 4.8 at $V = 500$ V.</p>	<p>$\Delta V/V (1 \text{ mA}) \leq 10\%$</p> <p>$R_{ins} \geq 1 \text{ M}\Omega$</p>
Fast temperature cycling	<p>IEC 60068-2-14, test Na, LCT/UCT, dwell time 30 min, 5 cycles</p>	<p>$\Delta V/V (1 \text{ mA}) \leq 5\%$</p> <p>No visible damage</p>
Damp heat, steady state	<p>The specimen shall be subjected to 40 ± 2 °C, 90 to 95% r. H. for 56 days without load / with 10% of the maximum continuous DC operating voltage V_{DC}. Then stored at room temperature and normal humidity for 1 to 2 h.</p> <p>Thereafter, the change of V_v shall be measured. Thereafter, insulation resistance R_{ins} shall be measured according to CECC 42 000, test 4.8 at $V = 500$ V.</p>	<p>$\Delta V/V (1 \text{ mA}) \leq 10\%$</p> <p>$R_{ins} \geq 1 \text{ M}\Omega$</p>
Solderability	<p>IEC 60068-2-20, test Ta, method 1 with modified conditions for lead-free solder alloys: 245 °C, 3 s:</p> <p>After dipping the terminals to a depth of approximately 3 mm from the body in a soldering bath of 245 °C for 3 s, the terminals shall be visually examined.</p>	<p>The inspection shall be carried out under adequate light with normal eyesight or with the assistance of a magnifier capable of giving a magnification of 4 to 10 times. The dipped surface shall be covered with a smooth and bright solder coating with no more than small amounts of scattered imperfections such as pinholes or un-wetted or de-wetted areas. These imperfections shall not be concentrated in one area.</p>

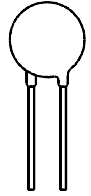
Reliability data

Test	Test methods/conditions	Requirement
Resistance to soldering heat	IEC 60068-2-20, test Tb, method 1A, 260 °C, 10 s: Each lead shall be dipped into a solder bath having a temperature of 260 ± 5 °C to a point 2.0 to 2.5 mm from the body of the specimen, be held there for 10 ± 1 s and then be stored at room temperature and normal humidity for 1 to 2 h. The change of V_v shall be measured and the specimen shall be visually examined.	$ \Delta V/V (1 \text{ mA}) \leq 5\%$ No visible damage
Tensile strength	IEC 60068-2-21, test Ua1 After gradually applying the force specified below and keeping the unit fixed for 10 s, the terminal shall be visually examined for any damage. Force for wire diameter: 1.0 mm = 20 N	$ \Delta V/V (1 \text{ mA}) \leq 5\%$ No break of solder joint, no wire break
Vibration	IEC 60068-2, test Fc Frequency range: 10 ... 55 Hz Amplitude: 0.75 mm or 98 m/s ² Duration: 6 h (3 · 2 h) Pulse: sine wave After repeatedly applying a single harmonic vibration according to the table above. The change of V_v shall be measured and the specimen shall be visually examined.	$ \Delta V/V (1 \text{ mA}) \leq 5\%$ No visible damage
Bump	IEC 60068-2-29, test Eb Pulse duration: 6 ms Max. acceleration: 400 m/s ² Number of bumps: 4000 Pulse: half sine	$ \Delta V/V (1 \text{ mA}) \leq 5\%$ No visible damage
Flammability	IEC 60695-2-2 (needle flame test) Severity: vertical 10 s	5 s max.

Note:

UCT = Upper category temperature

LCT = Lower category temperature

 R_{ins} = Insulation resistance to CECC 42 000, test 4.8

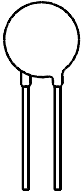

Leaded varistors

SuperiorR, S20 series

v/i characteristics

$v = f(i)$ – for explanation of the characteristics refer to “General technical information”, 1.6.3

A = Leakage current
B = Protection level

{ for worst-case varistor tolerances

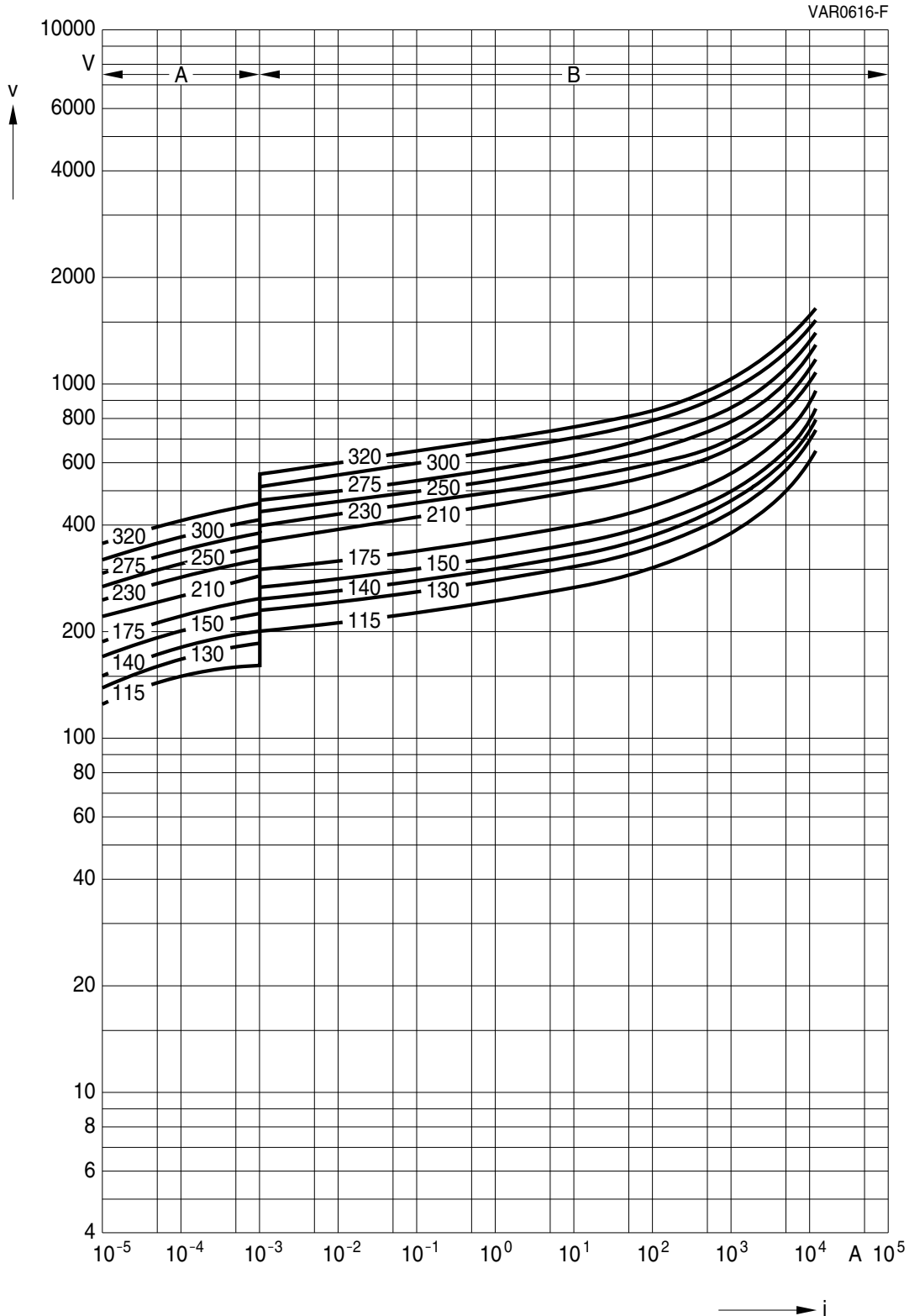

SIOV-S20 ... E3

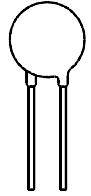

Leaded varistors
SuperioR, S20 series

Derating curves

Maximum surge current $i_{max} = f(t_r, \text{pulse train})$

For explanation of the derating curves refer to “General technical information”, section 1.8.1

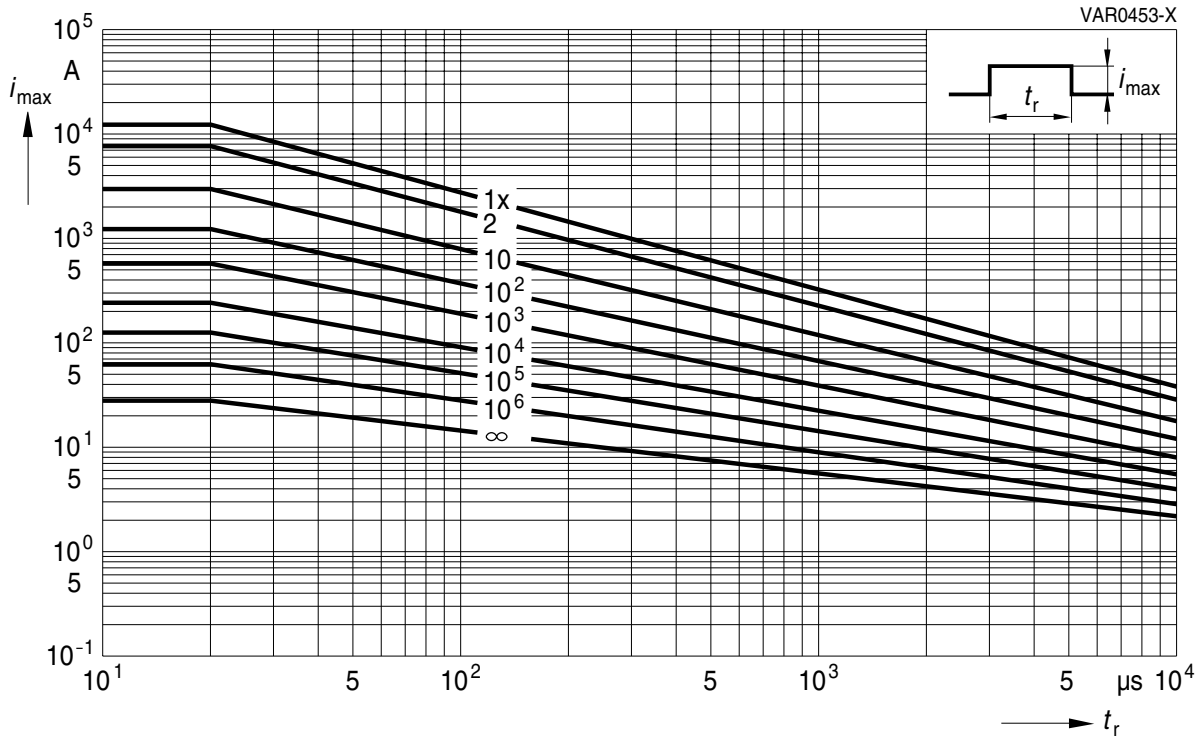

SIOV-S20 ... E3

Cautions and warnings

General

1. EPCOS metal oxide varistors (SIOVs) are designed for specific applications and should not be used for purposes not identified in our specifications, application notes and data books unless otherwise agreed with EPCOS during the design-in-phase.
2. Ensure suitability of SIOVs through reliability testing during the design-in phase. SIOVs should be evaluated taking into consideration worst-case conditions.
3. For applications of SIOVs in line-to-ground circuits based on various international and local standards there are restrictions existing or additional safety measures required.

Storage

1. Store SIOVs only in original packaging. Do not open the package before storage.
2. Storage conditions in original packaging:
Storage temperature: $-25\text{ °C} \dots +45\text{ °C}$
Relative humidity: $<75\%$ annual average,
 $<95\%$ on maximum 30 days a year.
Dew precipitation: Is to be avoided.
3. Avoid contamination of an SIOV's surface during storage, handling and processing.
4. Avoid storage of SIOVs in harmful environments that can affect the function during long-term operation (examples given under operation precautions).
5. The SIOV type series should be soldered within the time specified:
SIOV-S, -Q, -LS 24 months
ETFV and SFS types 12 months.

Handling

1. SIOVs must not be dropped.
2. Components must not be touched with bare hands. Gloves are recommended.
3. Avoid contamination of the surface of SIOV electrodes during handling, be careful of the sharp edge of SIOV electrodes.

Soldering (where applicable)

1. Use rosin-type flux or non-activated flux.
2. Insufficient preheating may cause ceramic cracks.
3. Rapid cooling by dipping in solvent is not recommended.
4. Complete removal of flux is recommended.

Leaded varistors

SuperioR, S20 series

Mounting

1. Potting, sealing or adhesive compounds can produce chemical reactions in the SIOV ceramic that will degrade the component's electrical characteristics.
2. Overloading SIOVs may result in ruptured packages and expulsion of hot materials. For this reason SIOVs should be physically shielded from adjacent components.

Operation

1. Use SIOVs only within the specified temperature operating range.
2. Use SIOVs only within the specified voltage and current ranges.
3. Environmental conditions must not harm SIOVs. Use SIOVs only in normal atmospheric conditions. Avoid use in the presence of deoxidizing gases (chlorine gas, hydrogen sulfide gas, ammonia gas, sulfuric acid gas, etc), corrosive agents, humid or salty conditions. Avoid contact with any liquids and solvents.



Important notes

The following applies to all products named in this publication:

1. Some parts of this publication contain **statements about the suitability of our products for certain areas of application**. These statements are based on our knowledge of typical requirements that are often placed on our products in the areas of application concerned. We nevertheless expressly point out **that such statements cannot be regarded as binding statements about the suitability of our products for a particular customer application**. As a rule, EPCOS is either unfamiliar with individual customer applications or less familiar with them than the customers themselves. For these reasons, it is always ultimately incumbent on the customer to check and decide whether an EPCOS product with the properties described in the product specification is suitable for use in a particular customer application.
2. We also point out that **in individual cases, a malfunction of passive electronic components or failure before the end of their usual service life cannot be completely ruled out in the current state of the art, even if they are operated as specified**. In customer applications requiring a very high level of operational safety and especially in customer applications in which the malfunction or failure of a passive electronic component could endanger human life or health (e.g. in accident prevention or life-saving systems), it must therefore be ensured by means of suitable design of the customer application or other action taken by the customer (e.g. installation of protective circuitry or redundancy) that no injury or damage is sustained by third parties in the event of malfunction or failure of a passive electronic component.
3. **The warnings, cautions and product-specific notes must be observed.**
4. In order to satisfy certain technical requirements, **some of the products described in this publication may contain substances subject to restrictions in certain jurisdictions (e.g. because they are classed as hazardous)**. Useful information on this will be found in our Material Data Sheets on the Internet (www.epcos.com/material). Should you have any more detailed questions, please contact our sales offices.
5. We constantly strive to improve our products. Consequently, **the products described in this publication may change from time to time**. The same is true of the corresponding product specifications. Please check therefore to what extent product descriptions and specifications contained in this publication are still applicable before or when you place an order. We also **reserve the right to discontinue production and delivery of products**. Consequently, we cannot guarantee that all products named in this publication will always be available. The aforementioned does not apply in the case of individual agreements deviating from the foregoing for customer-specific products.
6. Unless otherwise agreed in individual contracts, **all orders are subject to the current version of the “General Terms of Delivery for Products and Services in the Electrical Industry” published by the German Electrical and Electronics Industry Association (ZVEI)**.
7. The trade names EPCOS, BAOKE, Alu-X, CeraDiode, CSSP, DSSP, MiniBlue, MKK, MLSC, MotorCap, PCC, PhaseCap, PhaseMod, SIFERRIT, SIFI, SIKOREL, SilverCap, SIMDAD, SIMID, SineFormer, SIOV, SIP5D, SIP5K, ThermoFuse, WindCap are **trademarks registered or pending** in Europe and in other countries. Further information will be found on the Internet at www.epcos.com/trademarks.

Looking for pricing, stock, or lifecycle information?

Click below to explore more details on WIN SOURCE:

-  [View B72220S3301K101 on WIN SOURCE](#)
-  [TDK Corporation Information](#)

Optimize Your Supply Chain with WIN SOURCE Solutions

-  Global Sourcing Solution
-  Obsolete Management
-  Cost Control Management
-  Shortage Management
-  Alternative Solution
-  Excess Inventory Management