



THE DATASHEET OF FAN7300GX



FAN7300

LCD Back Light Inverter Drive IC

Features

- High Efficiency Single Stage Power Conversion
- Wide Input Voltage Range 6V to 25V
- Back Light Lamp Ballast and Soft Dimming
- Few External Components
- Precision Voltage Reference Trimmed to 2%
- Soft Start
- PWM and PFM Control
- Analog, Burst and Mixed Dimming Function
- Allows All N-Channel MOSFET Drive
- Double Pulse Suppression Logic
- Open Lamp Detection
- Output Short Circuit Protection
- Open Lamp Regulation
- 20 Pin SSOP

Description

The FAN7300 provides all the control functions for a series parallel resonant converter and also contains a pulse width modulation (PWM) controller to develop a supply voltage. Typical operating frequency range is between 30kHz and 100kHz depending on the CCFL and the transformer's characteristics.



Internal Block Diagram

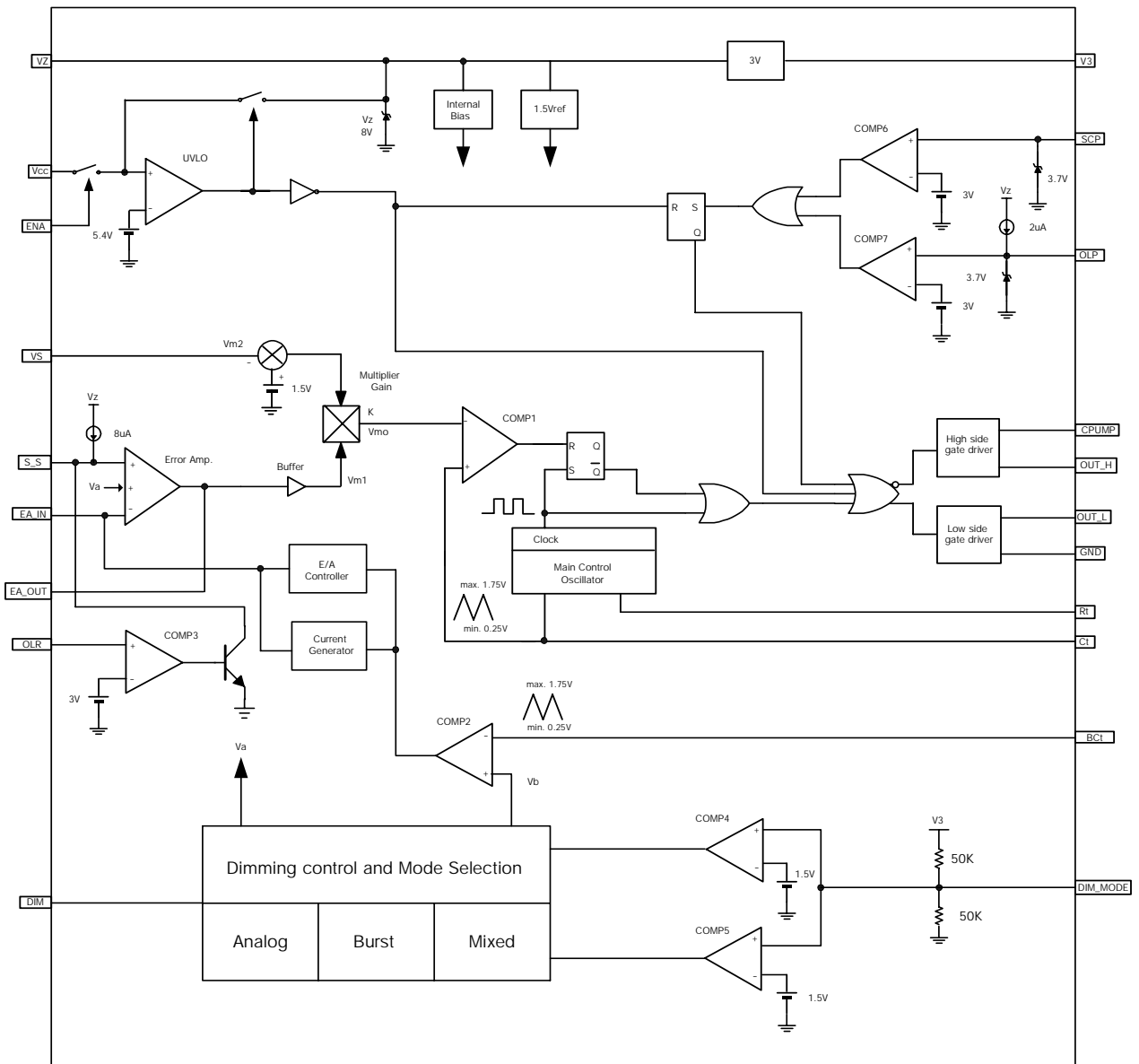

Pin Assignments

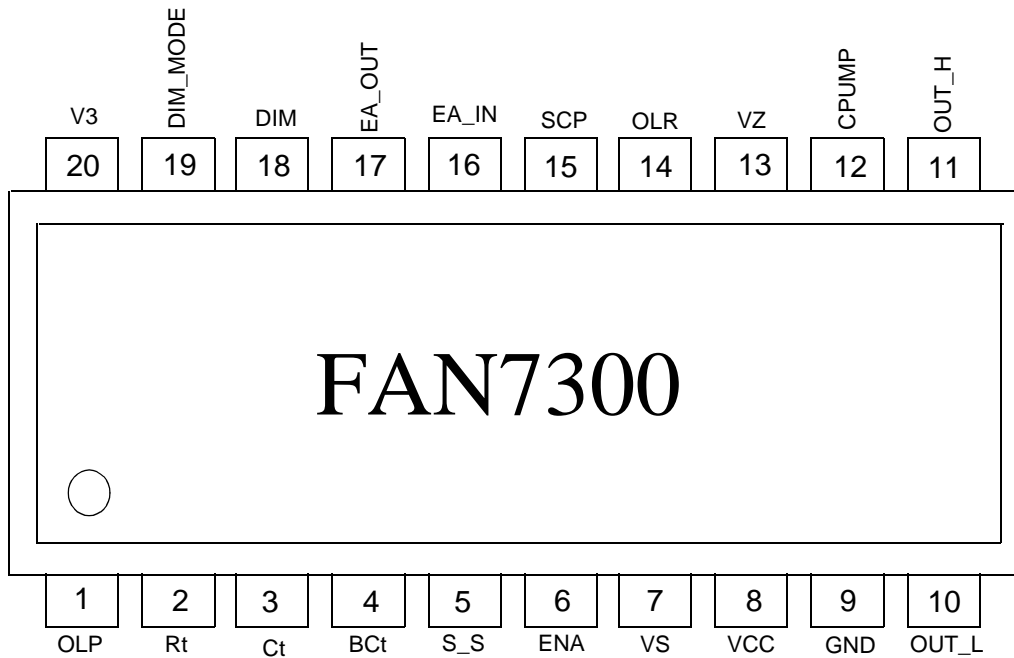

Pin Definitions

No	Name	Function Description	No	Name	Function Description
1	OLP	Open Lamp Protection	11	OUT_H	High Side Gate Drive Output
2	Rt	Timing Resistor	12	CPUMP	Charge Pump
3	Ct	Timing Capacitor	13	VZ	Zener Voltage
4	BCt	Burst Dimming Timing Capacitor	14	OLR	Open Lamp Regulation
5	S_S	Soft Start	15	SCP	Short Circuit Protection
6	ENA	Enable Input	16	EA_IN	Error Amplifier Input
7	VS	Voltage Sensing	17	EA_OUT	Error Amplifier Output
8	VCC	Supply Voltage	18	DIM	Dimming Input
9	GND	Ground	19	DIM_MODE	Dimming Mode Selection
10	OUT_L	Low Side Gate Drive Output	20	V3	3V Reference Voltage

Absolute Maximum Ratings

V_{CC}=10V, for typical values T_a=25°C, for min/max values T_a is the operating ambient temperature range with -25°C ≤ T_a ≤ 85°C and 6V ≤ V_{CC} ≤ 25V, unless otherwise specified.

Characteristics	Symbol	Value	Unit
Supply Voltage	V _{CC}	6 ~ 25	V
Operating Temperature Range	T _{opr}	-25 ~ 85	°C
Storage Temperature Range	T _{stg}	-65 ~ 150	°C
Thermal Resistance Junction-Air (Note1,2)	R _{θJA}	112	°C/W
Power Dissipation	P _d	1.1	W

Note:

1. Thermal resistance test board
Size: 76.2mm * 114.3mm * 1.6mm(1S0P)
JEDEC standard: JESD51-3, JESD51-7
2. Assume no ambient airflow

Electrical Characteristics

V_{CC}=10V, for typical values T_a=25°C, for min/max values T_a is the operating ambient temperature range with -25°C ≤ T_a ≤ 85°C and 6V ≤ V_{CC} ≤ 25V, unless otherwise specified.

Characteristics	Symbol	Test Condition	Min.	Typ.	Max.	Unit
REFERENCE SECTION						
Reference Voltage	V _{ref}	-	1.46	1.5	1.54	V
Line Regulation	ΔV _{ref}	8 ≤ V _{CC} ≤ 20V	-	2	25	mV
3V Regulation Voltage	V ₃	-	2.86	2.96	3.06	V
OSCILLATOR SECTION(MAIN)						
Oscillation Frequency	f _{osc}	C _t = 330pF, R _t = 14k	75	95	115	kHz
CT High Voltage	V _{cth}	-	-	1.75	-	V
CT Low Voltage	V _{bct1}	-	-	0.25	-	V
OSCILLATOR SECTION(BURST)						
Oscillation Frequency	f _{osc}	C _{tb} = 180nF	125	170	205	Hz
BCT High Voltage	V _{bcth}	-	-	1.75	-	V
BCT Low Voltage	V _{bct1}	-	-	0.25	-	V
ERROR AMP SECTION						
Feedback Output High Voltage	V _{eh}	EA_IN = 0V	3.2	3.7	4.2	V
Output Sink Current	I _{sin}	EA_OUT = 2.2V	-	-	-1	mA
Output Source Current	I _{sur}	EA_OUT = 2.2V	1	-	-	mA
Feedback High Voltage On Burst Dimming	V _{fbh}	R(EA_IN) = 50kΩ	V _a +0.1	V _a +0.4	V _a +0.7	V
MULTIPLIER SECTION						
Multiplier Input Voltage High	V _{mih}	-	1.4	1.6	1.8	V
Multiplier Gain	K	-	-	0.85	-	1/V
SOFT START SECTION						
Soft Start Current	I _{SS}	S_S=2V	5	8.3	11.6	uA
Soft Start Clamping Voltage	V _{ssh}	-	3	3.7	4.4	V
PROTECTION SECTION						
Open Lamp Protection Voltage	V _{pr}	-	2.5	3	3.5	V
Short Circuit Protection Voltage	V _{sc}	-	2.5	3	3.5	V
Open Lamp Regulation	V _{or}	-	2.5	3	3.5	V

Electrical Characteristics (Continued)

V_{CC}=10V, for typical values T_a=25°C, for min/max values T_a is the operating ambient temperature range with -25°C ≤ T_a ≤ 85°C and 6V ≤ V_{CC} ≤ 25V, unless otherwise specified.

Characteristics	Symbol	Test Condition	Min.	Typ.	Max.	Unit
DIMMING SECTION						
Analog Dimming Range	V _{aal}	Dim_Mode > 2V, Dim = 0	-0.5	0	0.5	V
	V _{aah}	Dim_Mode > 2V, Dim = 3V	2.5	3	3.5	V
	V _{ba}	Dim_Mode > 2V	-	3	-	V
Burst Dimming Range	V _{bbl}	Dim_Mode < 1V, Dim = 0	-0.5	0	0.5	V
	V _{bh}	Dim_Mode < 1V, Dim = 3V	2.1	2.5	2.9	V
	V _{ab}	Dim_Mode < 1V	2.45	2.85	3.25	V
Mixed Dimming Range	V _{aml}	Dim_Mode = 1.5V, Dim = 0	1.2	1.4	1.6	V
	V _{amh}	Dim_Mode = 1.5V, Dim = 3V	2.5	3	3.5	V
	V _{bml}	Dim_Mode = 1.5V, Dim = 0	-0.5	0	0.5	V
	V _{bmh}	Dim_Mode = 1.5V, Dim = 3V	2.5	3	3.5	V
Analog Dimming Select Voltage	V _{sa}	-	1.5	2	2.5	V
Burst Dimming Select Voltage	V _{sb}	-	0.7	1	1.3	V
Mixed Dimming Select Voltage	V _{sm}	-	1.3	1.5	1.7	V
UNDER VOLTAGE LOCK OUT SECTION						
Start Threshold Voltage	V _{th}	-	4.8	5.4	6.0	V
Start Up Current	I _{st}	V _{CC} = 4.5V	-	150	250	uA
Operating Supply Current	I _{op}	V _{CC} = 10V	-	8.5	11	mA
Stand-by Current	I _{sb}	V _{CC} = 12V	-	80	150	uA
ON/OFF SECTION						
On State Input Voltage	V _{on}	-	0.7	-	-	V
OUTPUT SECTION						
Output High Voltage	V _{oh}	V _{CC} = 7V	5	-	-	V
Output Low Voltage	V _{ol}	V _{CC} = 7V	-	-	0.2	V
Output Voltage With UVLO Activated	V _{uv}	V _{CC} = 4.5V	-	-	0.9	V
Output High Clamping Voltage	V _{ohc}	V _{CC} = 20V	11	13.5	16	V
Rising Time	T _r	V _{CC} = 7V	-	100	200	ns
Falling Time	T _f	V _{CC} = 7V	-	50	200	ns

Typical Performance Characteristics

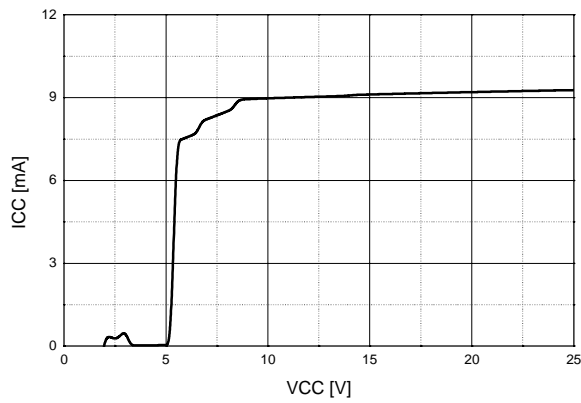

Figure 1. Supply Current vs. Supply Voltage

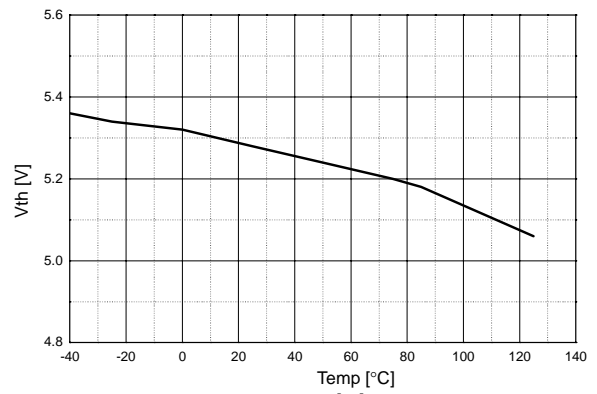

Figure 2. Start up Voltage

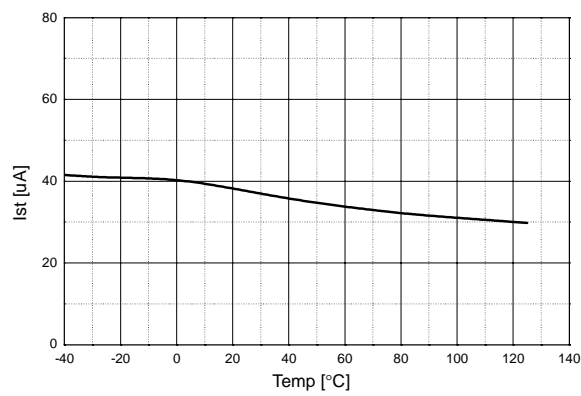

Figure 3. Start up Current

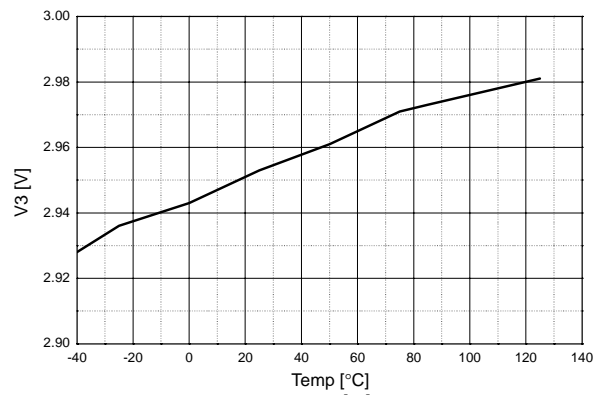

Figure 4. 3V Reference Voltage

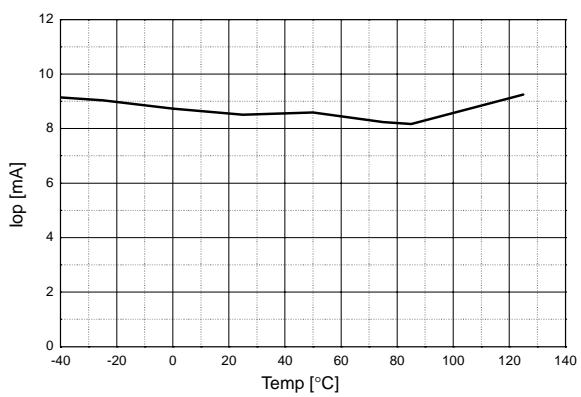

Figure 5. Operating Supply Current

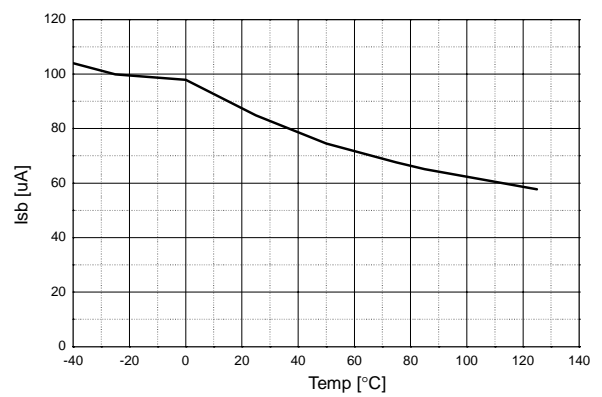

Figure 6. Stand by Current

Typical Performance Characteristics (Continued)

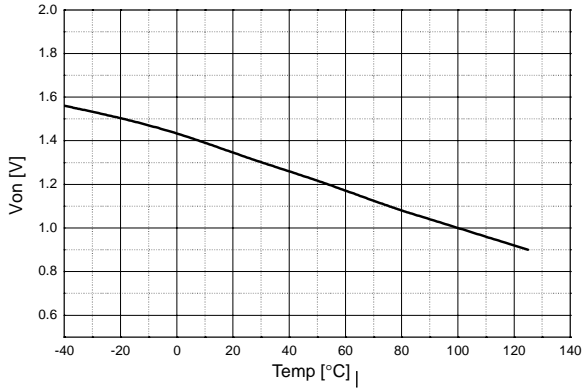

Figure 7. On State Input Voltage

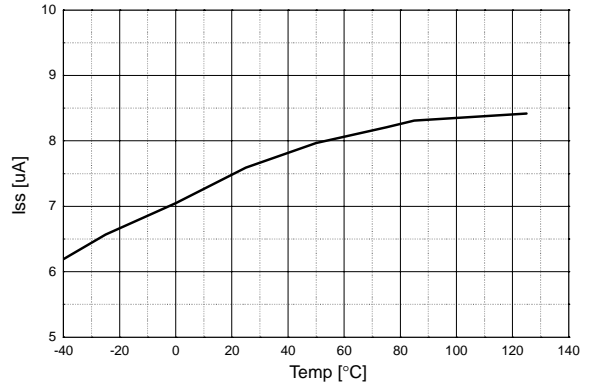

Figure 8. Soft Start Current

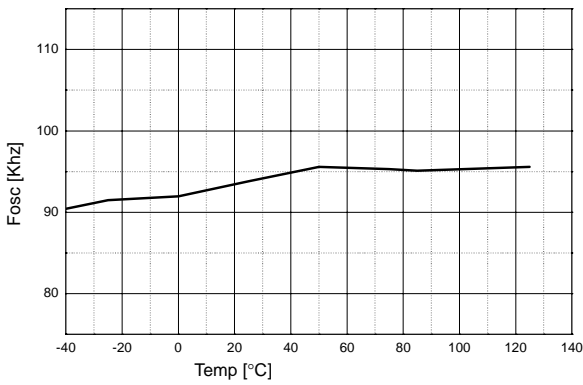

Figure 9. Oscillation Frequency (main)

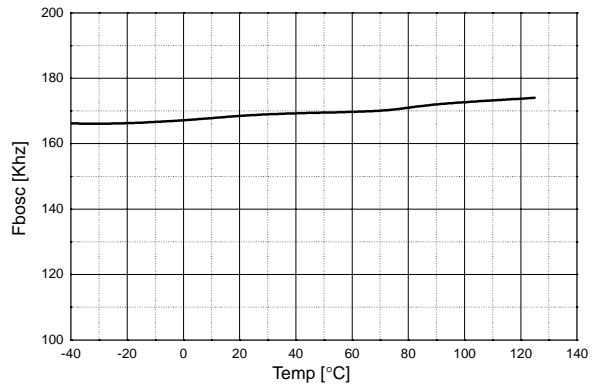

Figure 10. Oscillation Frequency (Burst)

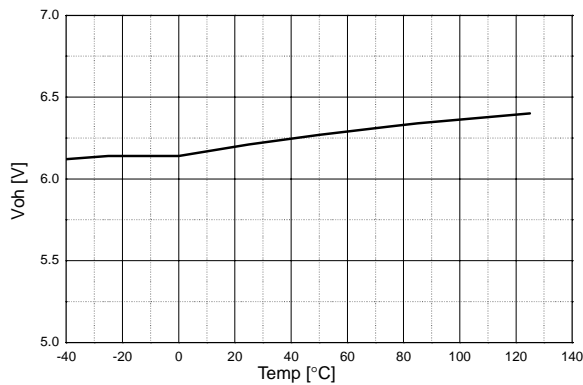

Figure 11. Output High Voltage

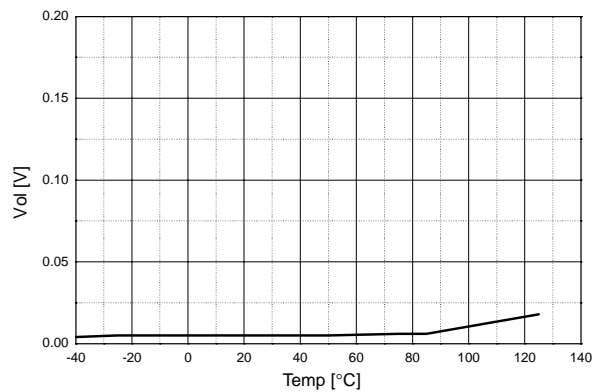

Figure 12. Output Low Voltage

Typical Performance Characteristics (Continued)

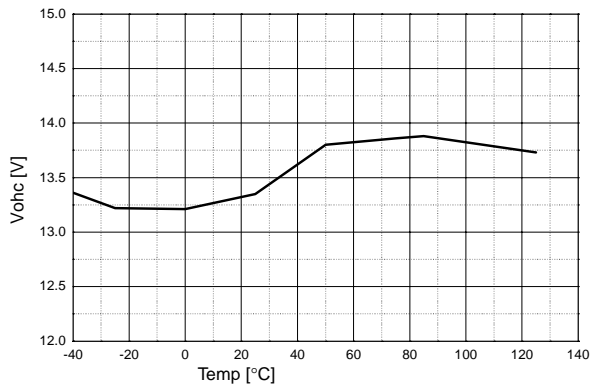

Figure 13. Output High Clamping Voltage

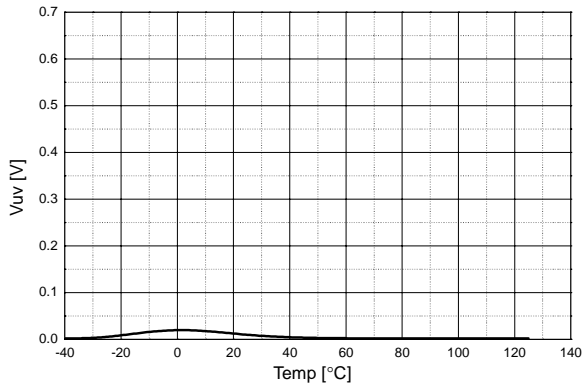

Figure 14. Output Voltage With UVLO Activated

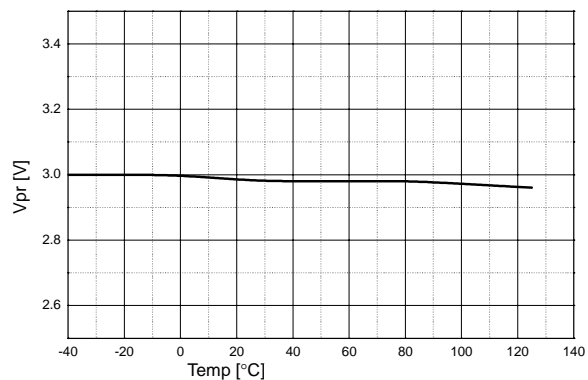

Figure 15. Open Lamp Protection Voltage

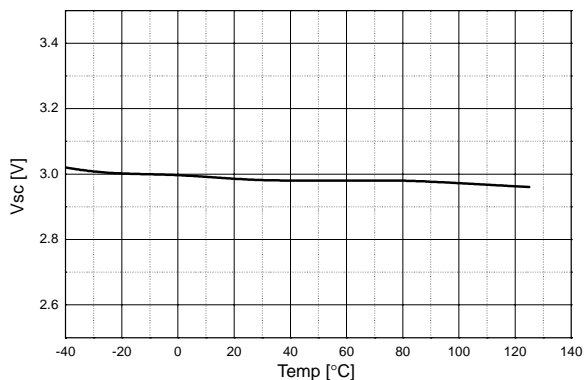

Figure 16. Short Circuit Protection Voltage

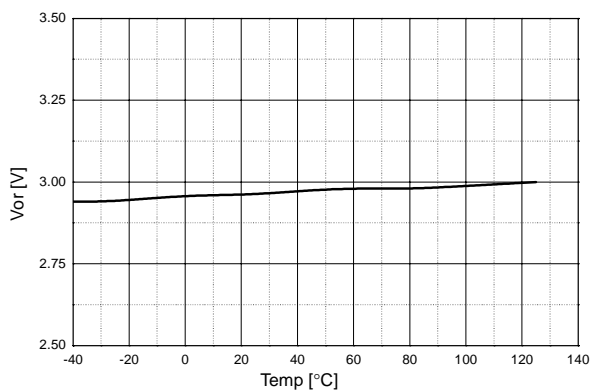

Figure 17. Open Lamp Regulation Voltage

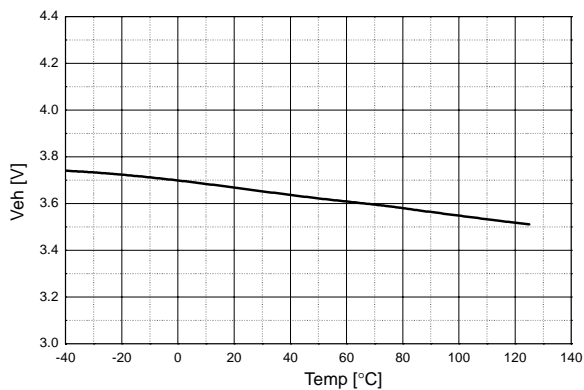

Figure 18. Error Amp Output High Voltage

Typical Performance Characteristics (Continued)

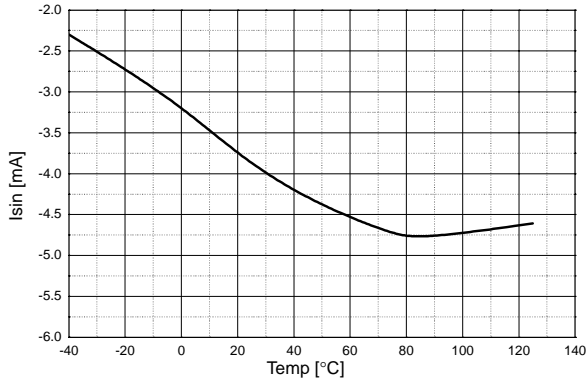

Figure 19. Output Sink Current

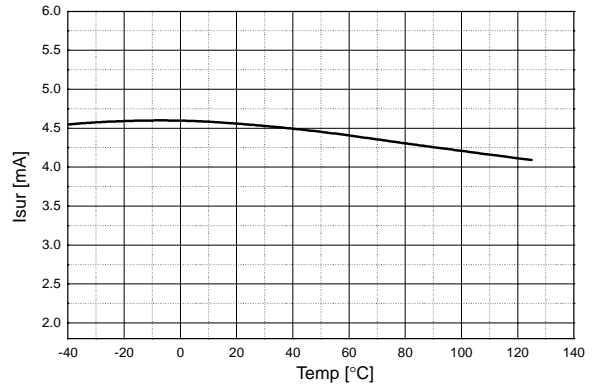

Figure 20. Output Source Current

Mechanical Dimensions

Package

Dimensions in millimeters

20-SSOP

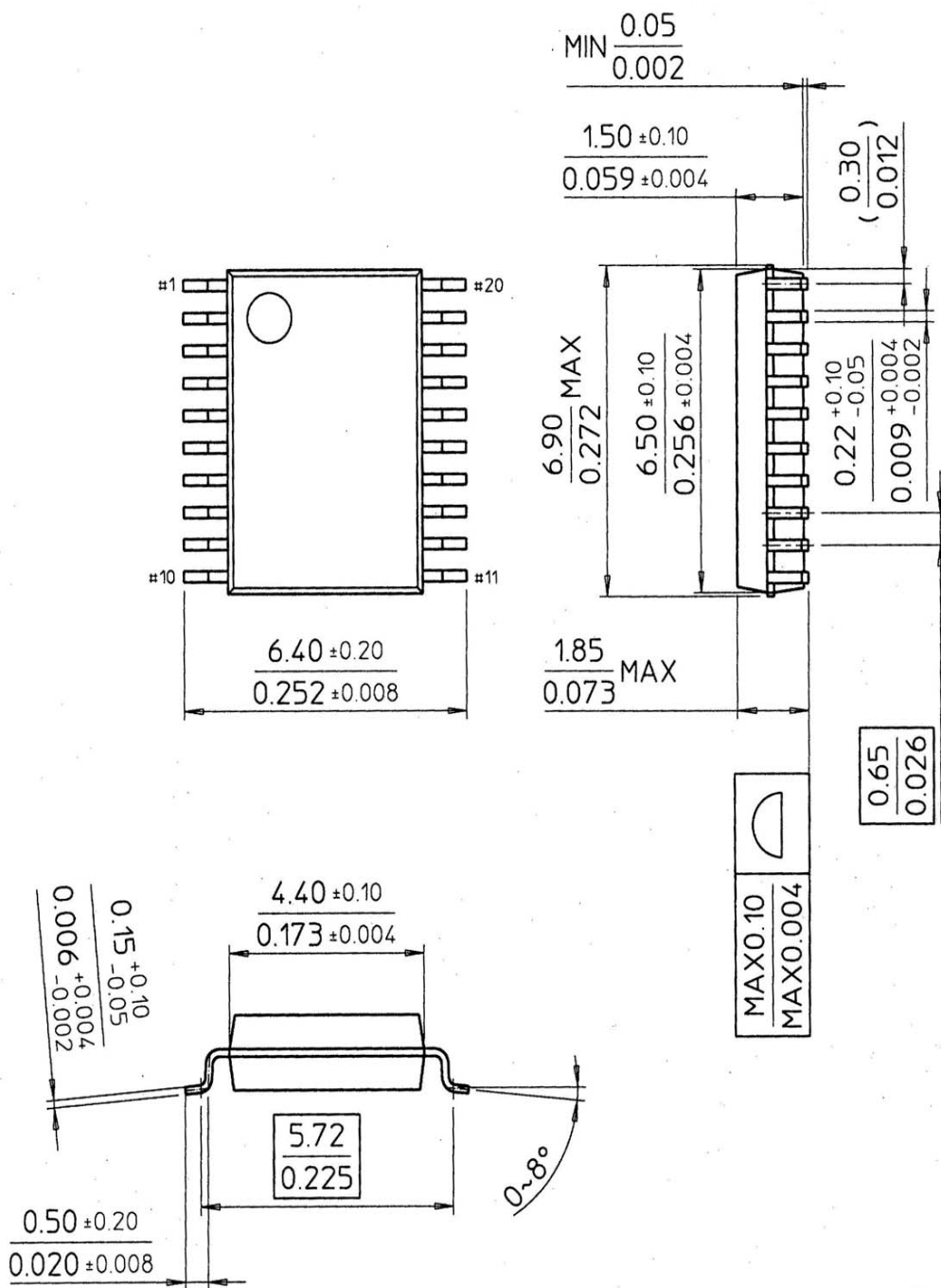

Ordering Information

Product number	Package	Operating Temperature
FAN7300G	20-SSOP	-25°C ~ 85°C

DISCLAIMER

FAIRCHILD SEMICONDUCTOR RESERVES THE RIGHT TO MAKE CHANGES WITHOUT FURTHER NOTICE TO ANY PRODUCTS HEREIN TO IMPROVE RELIABILITY, FUNCTION OR DESIGN. FAIRCHILD DOES NOT ASSUME ANY LIABILITY ARISING OUT OF THE APPLICATION OR USE OF ANY PRODUCT OR CIRCUIT DESCRIBED HEREIN; NEITHER DOES IT CONVEY ANY LICENSE UNDER ITS PATENT RIGHTS, NOR THE RIGHTS OF OTHERS.

LIFE SUPPORT POLICY

FAIRCHILD'S PRODUCTS ARE NOT AUTHORIZED FOR USE AS CRITICAL COMPONENTS IN LIFE SUPPORT DEVICES OR SYSTEMS WITHOUT THE EXPRESS WRITTEN APPROVAL OF THE PRESIDENT OF FAIRCHILD SEMICONDUCTOR CORPORATION. As used herein:

1. Life support devices or systems are devices or systems which, (a) are intended for surgical implant into the body, or (b) support or sustain life, and (c) whose failure to perform when properly used in accordance with instructions for use provided in the labeling, can be reasonably expected to result in a significant injury of the user.
2. A critical component in any component of a life support device or system whose failure to perform can be reasonably expected to cause the failure of the life support device or system, or to affect its safety or effectiveness.

Looking for pricing, stock, or lifecycle information?

Click below to explore more details on WIN SOURCE:

- [View FAN7300GX on WIN SOURCE](#)
- [Fairchild/ON Semiconductor Information](#)

Optimize Your Supply Chain with WIN SOURCE Solutions

- ✓ Global Sourcing Solution
- ✓ Obsolete Management
- ✓ Cost Control Management
- ✓ Shortage Management
- ✓ Alternative Solution
- ✓ Excess Inventory Management