

# FAN5109B

## Dual Bootstrapped 12V MOSFET Driver

### Features

- Drives N-Channel High-Side and Low-Side MOSFETs in a Synchronous Buck Configuration
- Enhanced Upgrade to FAN5109
- Direct Interface to FAN5029/FAN5182 and Other Compatible PWM Controllers
- 12V High-Side and 12V Low-Side Drive
- Internal Adaptive Shoot-Through Protection
- Fast Rise and Fall Times
- Switching Frequency Above 500kHz
- $\overline{OD}$  Input for Output Disable – Allows Synchronization with PWM Controller
- SOIC-8 Package
- TTL-Compatible Logic Inputs (New)

### Applications

- Multi-Phase VRM/VRD Regulators for Microprocessor Power
- High-Current, High-Frequency DC/DC Converters
- High-Power Modular Supplies
- General-Purpose TTL Input MOSFET Drivers

### Related Applications Notes

- [Application Note AN-6003, "Shoot-through" in Synchronous Buck Converters](#)

### Description

The FAN5109B is a dual, high-frequency MOSFET driver, specifically designed to drive N-channel power MOSFETs in a synchronous-rectified buck converter. These drivers, combined with a Fairchild multi-phase pulse-width-modulated (PWM) controller and power MOSFETs, form a complete core voltage regulator solution for advanced microprocessors.

The FAN5109B drives the upper and lower MOSFET gates of a synchronous buck regulator to  $12V_{GS}$ . The output drivers have the capacity to efficiently switch power MOSFETs at frequencies above 500kHz. The circuit's adaptive shoot-through protection prevents both MOSFETs from conducting simultaneously.

The FAN5109B is rated for operation from  $0^{\circ}\text{C}$  to  $+85^{\circ}\text{C}$  and is available in a low-cost SOIC-8 package.

### Ordering Information

Part Number	Pb-Free	Operating Temperature Range	Package	Packing Method	Quantity Per Reel
FAN5109BMX	Yes	$0^{\circ}\text{C}$ to $85^{\circ}\text{C}$	SOIC-8	Tape and Reel	2500

#### Note:

1. Contact a Fairchild sales representative for availability of leaded (Pb) parts.



## Pin Configuration

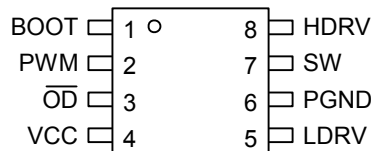

Figure 3. Pin Assignments

## Pin Definitions

Pin #	Name	Description
1	BOOT	<b>Bootstrap Supply Input.</b> Provides voltage supply to the high-side MOSFET driver. Connect to the bootstrap capacitor (see the <i>Applications</i> section).
2	PWM	<b>PWM Signal Input.</b> This pin accepts a logic-level PWM signal from the controller.
3	$\overline{\text{OD}}$	<b>Output Disable.</b> When LOW, this pin disables FET switching (HDRV and LDRV are held LOW). (Also referred to as OD#.)
4	VCC	<b>Power Input.</b> +12V chip bias power. Bypass with a 1 $\mu$ F ceramic capacitor.
5	LDRV	<b>Low-Side Gate Drive Output.</b> Connect to the gate of low-side power MOSFET(s).
6	PGND	<b>Power ground.</b> Connect directly to the source of the low-side MOSFET(s).
7	SW	<b>Switch Node Input.</b> Connect as shown in Figure 1. SW provides return for the high-side bootstrapped driver and acts as a sense point for the adaptive shoot-through protection.
8	HDRV	<b>High-Side Gate Drive Output.</b> Connect to the gate of high-side power MOSFET(s).

## Absolute Maximum Ratings

Stresses exceeding the absolute maximum ratings may damage the device. The device may not function or be operable above the recommended operating conditions and stressing the parts to these levels is not recommended. In addition, extended exposure to stresses above the recommended operating conditions may affect device reliability. The absolute maximum ratings are stress ratings only.

Parameter		Min.	Max.	Unit
VCC and LDRV to GND		-0.3	15.0	V
PWM and $\overline{\text{OD}}$ pins		-0.3	5.5	V
SW to GND	Continuous	-1.0	15.0	V
	Transient (t=100ns, f = 500kHz) <sup>(2)</sup>	-5.0	25.0	V
BOOT to SW	Continuous	-0.3	15.0	V
	Transient (t<20ns, f = 500kHz)	-2.0	17.0	V
BOOT to GND	Continuous	-0.3	30.0	V
	Transient (t=100ns, f =500kHz)		38.0	V
HDRV		V <sub>SW</sub> -1.0	V <sub>BOOT</sub> +0.3	V
LDRV	Continuous	-0.5	V <sub>CC</sub>	V
	Transient (t=200ns) <sup>(2)</sup>	-2.0	V <sub>CC</sub> +0.3	V
	Transient (t<20ns, f = 500kHz) <sup>(2)</sup>	-2.0	V <sub>CC</sub> +2.0	V

### Note:

2. For transient derating beyond the levels indicated, refer to Figure 17 and Figure 18.

## Thermal Information

Symbol	Parameter	Min.	Typ.	Max.	Unit
T <sub>J</sub>	Junction Temperature	0		150	°C
T <sub>STG</sub>	Storage Temperature	-65		150	°C
T <sub>L</sub>	Lead Soldering Temperature, 10 seconds			300	°C
T <sub>VP</sub>	Vapor Phase, 60 seconds			215	°C
T <sub>LI</sub>	Infrared, 15 seconds			220	°C
P <sub>D</sub>	Power Dissipation, T <sub>A</sub> = 25°C			715	mW
θ <sub>JC</sub>	Thermal Resistance, SO-8: Junction-to-Case		40		°C/W
θ <sub>JA</sub>	Thermal Resistance, SO-8: Junction-to-Ambient		140		°C/W

## Recommended Operating Conditions

The Recommended Operating Conditions table defines the conditions for actual device operation. Recommended operating conditions are specified to ensure optimal performance to the datasheet specifications. Fairchild does not recommend exceeding them or designing to Absolute Maximum Ratings.

Symbol	Parameter	Conditions	Min.	Typ.	Max.	Unit
V <sub>CC</sub>	Supply Voltage	VCC to GND	10.0	12.0	13.5	V
T <sub>A</sub>	Ambient Temperature		0		85	°C
T <sub>J</sub>	Junction Temperature		0		125	°C

## Electrical Characteristics

$V_{CC}$  and  $V_{LDRV} = 12V$  and  $T_A = 25^\circ C$  using the circuit in Figure 4, unless otherwise noted, each side. The “•” denotes specifications that apply over the full operating temperature range.

Symbol	Parameter	Conditions	Min.	Typ.	Max.	Unit
<b>Input Supply</b>						
$V_{CC}$	$V_{CC}$ Voltage Range		• 6.4	12.0	13.5	V
$I_{CC}$	$V_{CC}$ Current	$\overline{OD} = 0V$	•	2.5	4.0	mA
<b><math>\overline{OD}</math> Input</b>						
$V_{IH(OD)}$	Input High Voltage		• 2.0			V
$V_{IL(OD)}$	Input Low Voltage		•		0.8	V
$V_{HYS(OD)}$	Input Hysteresis		• 250	550		mV
$I_{OD}$	Input Current	$\overline{OD} = 3.0V$	• -300		+300	nA
$t_{pdI(OD)}$	Propagation Delay <sup>(4)</sup>	See Figure 5		25	40	ns
$t_{pdH(OD)}$				15	30	ns
<b>PWM Input</b>						
$V_{IH(PWM)}$	Input High Voltage		• 2.0			V
$V_{IL(PWM)}$	Input Low Voltage		•		0.8	V
$V_{HYS(PWM)}$	Input Hysteresis		• 200	550		mV
$I_{IL(PWM)}$	Input Current		• -1		+1	$\mu A$
<b>High-Side Driver</b>						
$R_{HUP}$	Output Resistance, Sourcing	$V_{BOOT} - V_{SW} = 12V$		2.5	3.3	$\Omega$
$I_{SOURCE(LDRV)}$	Source Current <sup>(4)</sup>	$V_{DS} = -10V$		2.0		A
$R_{HDN}$	Output Resistance, Sinking	$V_{BOOT} - V_{SW} = 12V$		1.1	1.5	$\Omega$
$I_{SINK(HDRV)}$	Sink Current <sup>(4)</sup>	$V_{DS} = 10V$		2.5		A
$t_{R(HDRV)}$	Transition Times <sup>(4,6)</sup>	See Figure 4		25	40	ns
$t_{F(HDRV)}$				15	25	
$t_{pdH(HDRV)}$	Propagation Delay <sup>(4,5)</sup>	See Figure 6		40	55	ns
$t_{pdI(HDRV)}$				25	40	
<b>Low-Side Driver</b>						
$R_{LUP}$	Output Resistance, Sourcing			2.0	2.6	$\Omega$
$I_{SOURCE(LDRV)}$	Source Current <sup>(4)</sup>	$V_{DS} = -10V$		2.5		A
$R_{LDN}$	Output Resistance, Sinking			0.9	1.2	$\Omega$
$I_{SINK(LDRV)}$	Sink Current <sup>(4)</sup>	$V_{DS} = 10V$		2.5		A
$BG_{th}$	Bottom Gate Threshold <sup>(4)</sup>		1.0	1.2	1.6	V
$t_{R(LDRV)}$	Transition Times <sup>(4,6)</sup>	See Figure 4		20	30	ns
$t_{F(LDRV)}$				15	25	
$t_{pdH(LDRV)}$	Propagation Delay <sup>(4,5)</sup>	See Figure 6		20	30	ns
$t_{pdI(LDRV)}$				15	25	
$t_{pdH(LDF)}$			See Adaptive Gate Drive Circuit Description		140	

### Notes:

- Limits at operating temperature extremes are guaranteed by design, characterization, and statistical quality control.
- Specifications guaranteed by design and characterization (not production tested).
- For propagation delays,  $t_{pdH}$  refers to low-to-high signal transition.  $t_{pdI}$  refers to high-to-low signal transition.
- Transition times are defined for 10% and 90% of DC values.

Test Diagrams

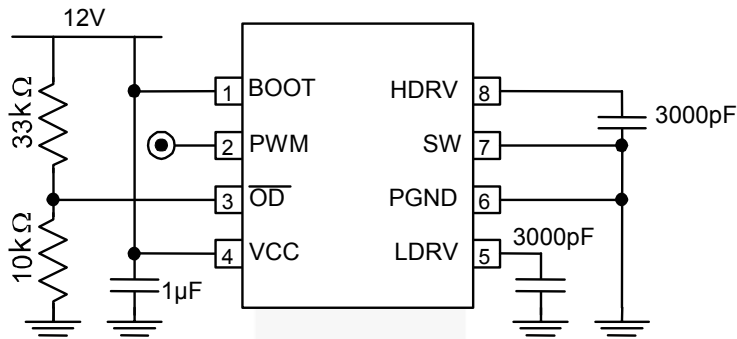

Figure 4. Test Circuit

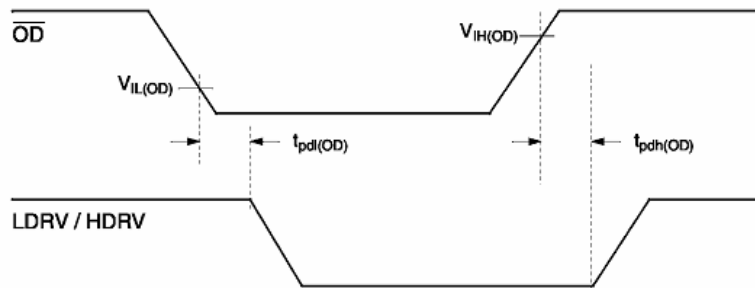

Figure 5. Output Disable Timing

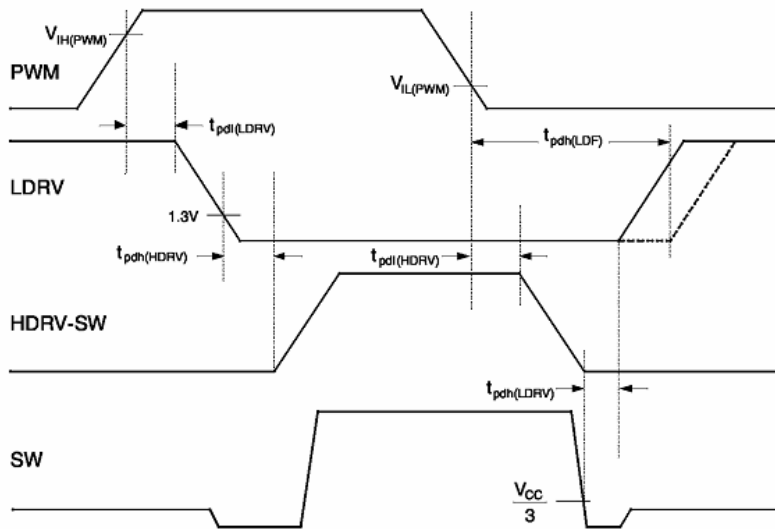

Figure 6. Adaptive Gate Drive Timing

### Typical Performance Characteristics

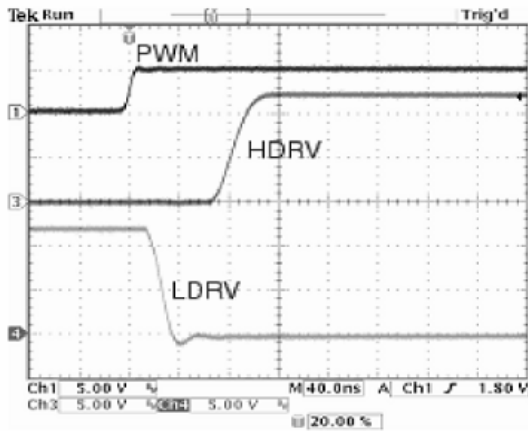

Figure 7. Gate Drive Rise and Fall Times (1)

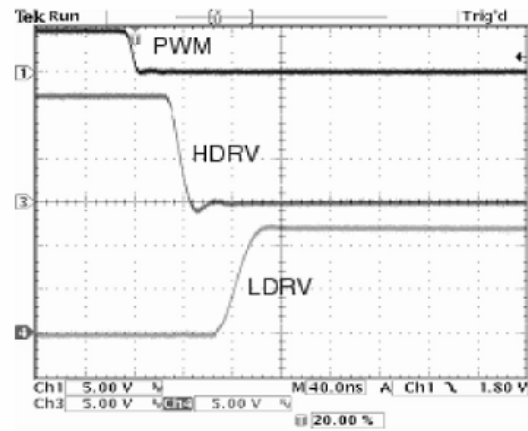

Figure 8. Gate Drive Rise and Fall Times (2)

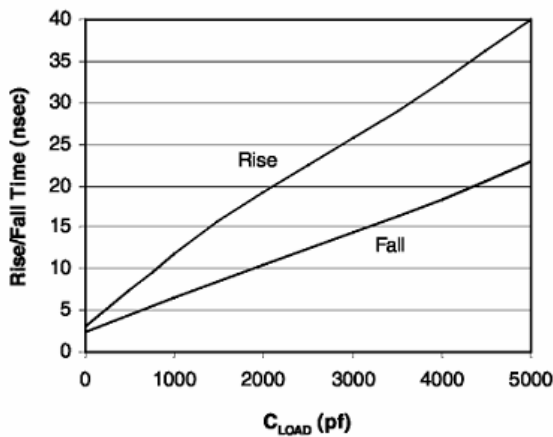

Figure 9. HDRV Rise and Fall Times vs. C<sub>LOAD</sub>

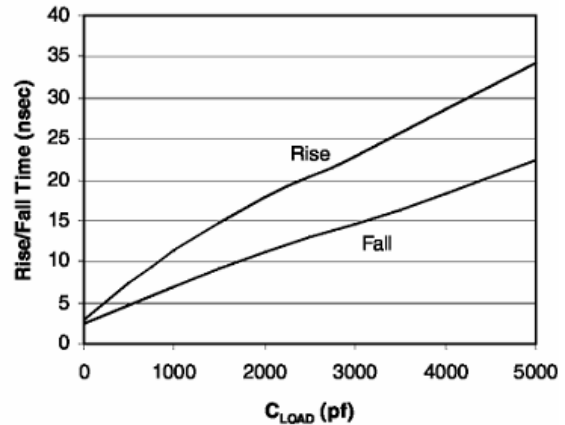

Figure 10. LDRV Rise and Fall Times vs. C<sub>LOAD</sub>

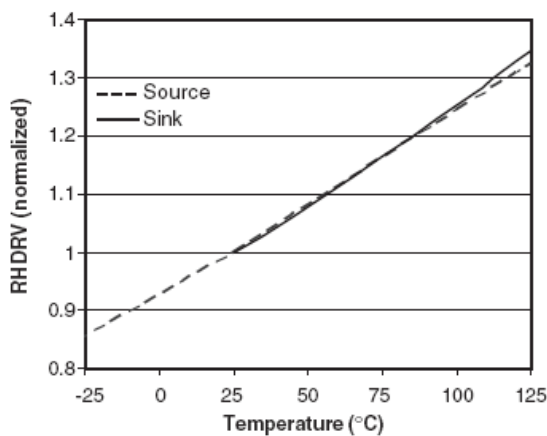

Figure 11. HDRV Normalized Impedance vs. Temperature

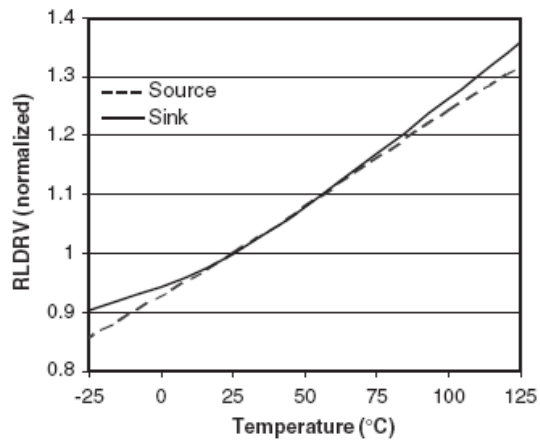

Figure 12. LDRV Normalized Impedance vs. Temperature

**Typical Performance Characteristics** (Continued)

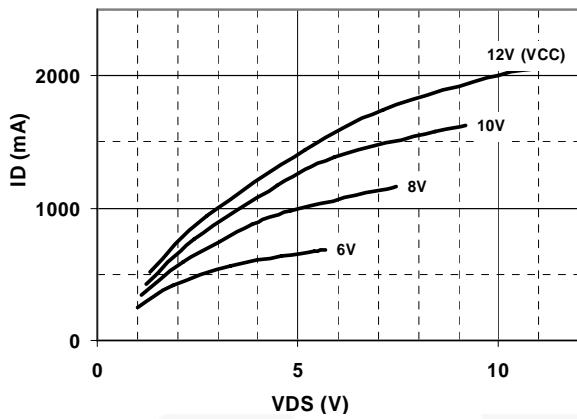

Figure 13. HDRV Pull-Up (Sourcing)

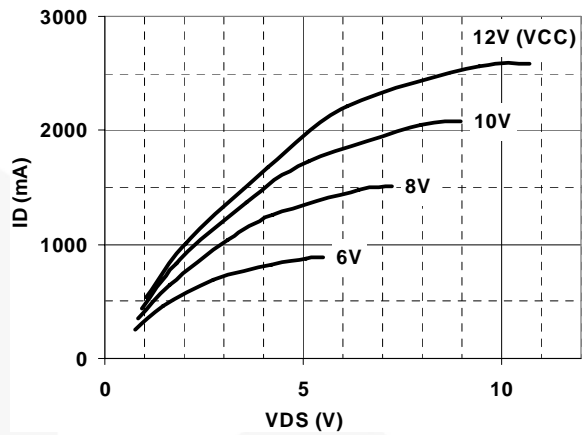

Figure 14. LDRV Pull-Up (Sourcing)

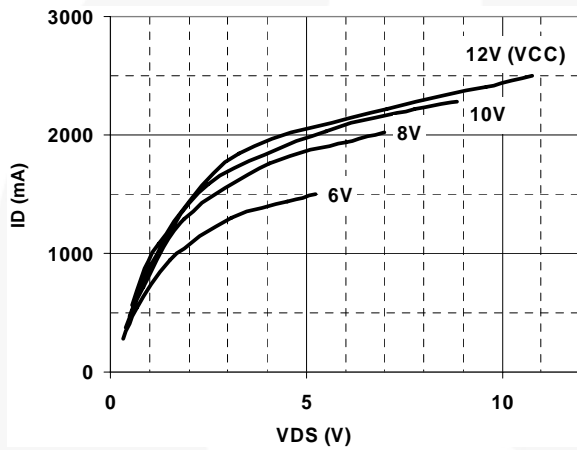

Figure 15. HDRV Pull-Down (Sinking)

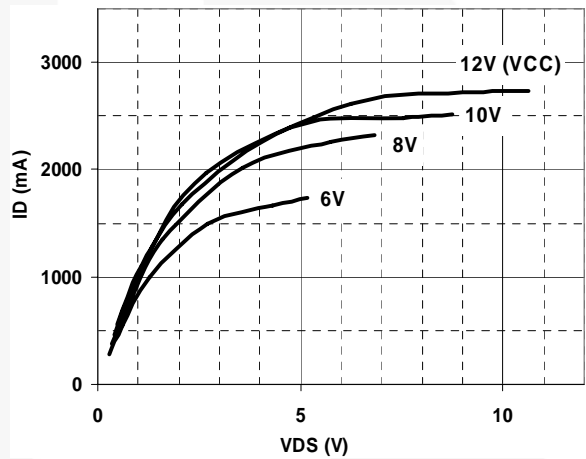

Figure 16. LDRV Pull-Down (Sinking)

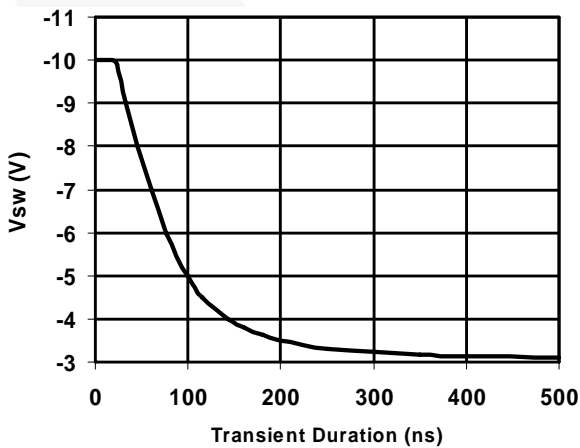

Figure 17. Negative SW Voltage Transient

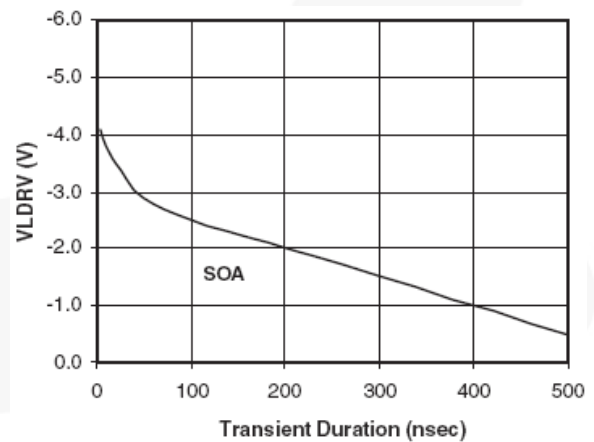

Figure 18. Negative LDRV Voltage Transient

Typical Performance Characteristics (Continued)

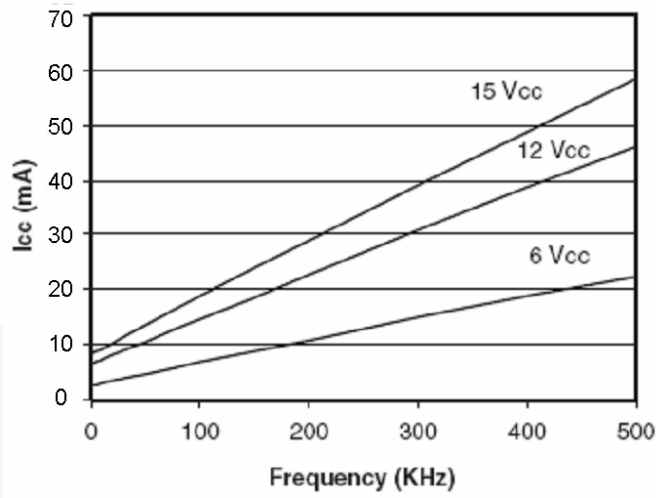

Figure 19. Operating Current vs. Frequency

## Circuit Description

The FAN5109B is optimized for driving N-channel MOSFETs in a synchronous buck converter topology. A single PWM input signal is all that is required to properly drive the high-side and low-side MOSFETs.

For a more detailed description of the FAN5109B and its features, refer to the Typical Application diagram in Figure 1 and Functional Block diagram in Figure 2.

### Low-Side Driver ( $\overline{\text{OD}} = \text{HIGH}$ )

The FAN5109B low-side driver (LDRV) is designed to drive ground-referenced, N-channel MOSFETs. The bias for LDRV is internally connected between VCC and PGND. When the driver is enabled, the driver LDRV output is 180° out of phase with the PWM input. When the FAN5109B is disabled ( $\overline{\text{OD}} = \text{LOW}$ ), LDRV is held LOW.

### High-Side Driver ( $\overline{\text{OD}} = \text{HIGH}$ )

The FAN5109B high-side driver (HDRV) is designed to drive a floating N-channel MOSFET. The bias voltage for the high-side driver is developed by a bootstrap supply circuit, consisting of an external diode and bootstrap capacitor ( $C_{\text{BOOT}}$ ).

During start-up, SW is initially at PGND, allowing  $C_{\text{BOOT}}$  to charge to  $V_{\text{CC}}$  through the external boot diode. When the PWM input goes HIGH, HDRV begins to charge the high-side MOSFET gate (Q1). During this transition, charge is transferred from  $C_{\text{BOOT}}$  to Q1 gate. As Q1 turns on, SW rises to  $V_{\text{IN}}$ , forcing the BOOT pin to  $V_{\text{IN}} + V_{\text{C}(\text{BOOT})}$ , which provides sufficient  $V_{\text{GS}}$  enhancement for Q1. To complete the switching cycle, Q1 is turned off by pulling HDRV to SW.  $C_{\text{BOOT}}$  is recharged to  $V_{\text{CC}}$  when SW falls to PGND.

HDRV output is in phase with the PWM input. When the driver is disabled, the high-side gate is held LOW.

### $\overline{\text{OD}}$ (aka #OD)

When the  $\overline{\text{OD}}$  signal is HIGH, the driver is enabled and the PWM signal controls the HDRV and LDRV outputs. When the  $\overline{\text{OD}}$  signal is LOW, the driver is disabled and the PWM signal is ignored. When the  $\overline{\text{OD}}$  signal is LOW, both the HDRV and LDRV outputs are forced LOW to turn off both the upper and lower output FETs.

## Adaptive Gate Drive Circuit

The FAN5109B ensures minimum MOSFET dead-time while eliminating potential shoot-through (cross-conduction) currents. It senses the state of the MOSFETs and adjusts the gate drive, adaptively, to ensure they do not conduct simultaneously. Refer to the gate drive rise and fall time waveforms shown in Figure 7 and Figure 8 for the relevant timing information.

To prevent overlap during the LOW-to-HIGH switching transition (Q2 OFF to Q1 ON), the adaptive circuitry monitors the voltage at the LDRV pin. When the PWM signal goes HIGH, Q2 begins to turn OFF after a propagation delay, as defined by  $t_{\text{pd}(\text{LDRV})}$  parameter. Once the LDRV pin is discharged below  $\sim 1.2\text{V}$ , Q1 begins to turn ON after the adaptive delay  $t_{\text{pdh}(\text{HDRV})}$ .

To preclude overlap during the HIGH-to-LOW transition (Q1 OFF to Q2 ON), the adaptive circuitry monitors the voltage at the SW pin. When the PWM signal goes LOW, Q1 begins to turn OFF after a propagation delay ( $t_{\text{pd}(\text{HDRV})}$ ). Once the SW pin falls below  $V_{\text{CC}}/3$ , Q2 begins to turn ON after the adaptive delay  $t_{\text{pdh}(\text{LDRV})}$ .

Additionally,  $V_{\text{GS}}$  of Q1 is monitored. When  $V_{\text{GS}(\text{Q1})}$  is discharged below  $\sim 1.2\text{V}$ , a secondary adaptive delay is initiated, which results in Q2 being driven ON after  $t_{\text{pdh}(\text{LDF})}$ , regardless of the SW state. This function is implemented to ensure  $C_{\text{BOOT}}$  is recharged after each switching cycle, particularly for cases where the power converter is sinking current and the SW voltage does not fall below the  $V_{\text{CC}}/3$  adaptive threshold. The secondary delay  $t_{\text{pdh}(\text{LDF})}$  is longer than  $t_{\text{pdh}(\text{LDRV})}$ .

## Application Information

### Supply Capacitor Selection

To reduce the noise and to supply the peak current, a local ceramic bypass capacitor is recommended for the supply input ( $V_{CC}$ ). Use at least a 1 $\mu$ F, X7R or X5R capacitor. Keep this capacitor close to the VCC and PGND pins.

### Bootstrap Circuit

The bootstrap circuit uses a charge storage capacitor ( $C_{BOOT}$ ) and an external diode, as shown in Figure 1. These components should be selected after the high-side MOSFET has been chosen. The required capacitance is determined using the following equation:

$$C_{BOOT} = \frac{Q_G}{\Delta V_{BOOT}} \quad \text{EQ. 1}$$

where  $Q_G$  is the total gate charge of the high-side MOSFET and  $\Delta V_{BOOT}$  is the voltage droop allowed on the high-side MOSFET drive. For example, the  $Q_G$  of a FDD6696 MOSFET is about 35nC at 12V $_{GS}$ . For an allowed droop of ~300mV, the required bootstrap capacitance is 100nF. A good quality ceramic capacitor must be used. The average diode forward current,  $I_{F(AVG)}$ , can be estimated by:

$$I_{F(AVG)} = Q_{GATE} \times F_{SW} \quad \text{EQ. 2}$$

where  $F_{SW}$  is the switching frequency of the controller.

The peak surge current rating of the diode should be checked in-circuit, since this is dependent on the equivalent impedance of the entire bootstrap circuit, including the PCB traces.

### Thermal Considerations

Total device dissipation:

$$P_{Dtot} = P_Q + P_{HDRV} + P_{LDRV} \quad \text{EQ. 3}$$

where:

- $P_Q$  represents quiescent power dissipation:  

$$P_Q = V_{CC} \times [4mA + 0.036 (F_{SW} - 100)] \quad \text{EQ. 4}$$
- $F_{SW}$  is switching frequency (in kHz).
- $P_{HDRV}$  represents internal power dissipation of the upper FET driver.
- $P_{H(R)}$  and  $P_{H(F)}$  are internal dissipations for the rising and falling edges, respectively:

$$P_{HDRV} = P_{H(R)} + P_{H(F)} \quad \text{EQ. 5}$$

$$P_{H(R)} = P_{Q1} \times \frac{R_{HUP}}{R_{HUP} + R_E + R_G} \quad \text{EQ. 6}$$

$$P_{H(F)} = P_{Q1} \times \frac{R_{HDN}}{R_{HDN} + R_E + R_G} \quad \text{EQ. 7}$$

$$P_{Q1} = \frac{1}{2} \times Q_{G1} \times V_{GS(Q1)} \times F_{SW} \quad \text{EQ. 8}$$

where:

- $Q_{G1}$  is total gate charge of the upper FET (Q1) for its applied  $V_{GS}$ .

As described in Equations 6 and 7, the total power consumed driving the gate is divided in proportion to the resistances in series with the MOSFET internal gate node, as shown below:

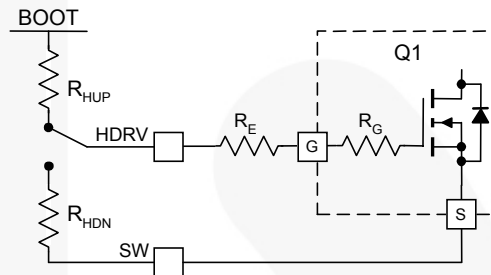

**Figure 20. Driver Dissipation Model**

$R_G$  is the gate resistance internal to the FET.  $R_E$  is the external gate drive resistor implemented in many designs. Note that the introduction of  $R_E$  can reduce driver power dissipation, but excess  $R_E$  may cause errors in the “adaptive gate drive” circuitry. In particular, adding  $R_E$  in the low drive circuit could result in shoot through. For more information, refer to [Application Note AN-6003, “Shoot-through” in Synchronous Buck Converters](#).

$P_{LDRV}$  is dissipation of the lower FET driver:

$$P_{LDRV} = P_{L(R)} + P_{L(F)} \quad \text{EQ. 9}$$

where:

$P_{L(R)}$  and  $P_{L(F)}$  are internal dissipations for the rising and falling edges, respectively:

$$P_{L(R)} = P_{Q2} \times \frac{R_{LUP}}{R_{LUP} + R_E + R_G} \quad \text{EQ. 10}$$

$$P_{L(F)} = P_{Q2} \times \frac{R_{LDN}}{R_{LDN} + R_E + R_G} \quad \text{EQ. 11}$$

$$P_{Q2} = \frac{1}{2} \times Q_{G2} \times V_{GS(Q2)} \times F_{SW} \quad \text{EQ. 12}$$

## Layout Considerations

Use the following general guidelines when designing printed circuit boards (see Figure 21):

- Trace out the high-current paths and use short, wide (>25 mil) traces to make these connections.
- Connect the PGND pin as close as possible to the source of the lower MOSFET.
- The  $V_{CC}$  bypass capacitor should be located as close as possible to VCC and PGND pins.
- Use vias to other layers where possible to maximize thermal conduction away from the IC.

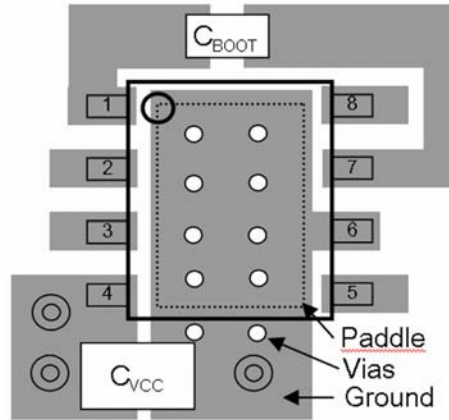
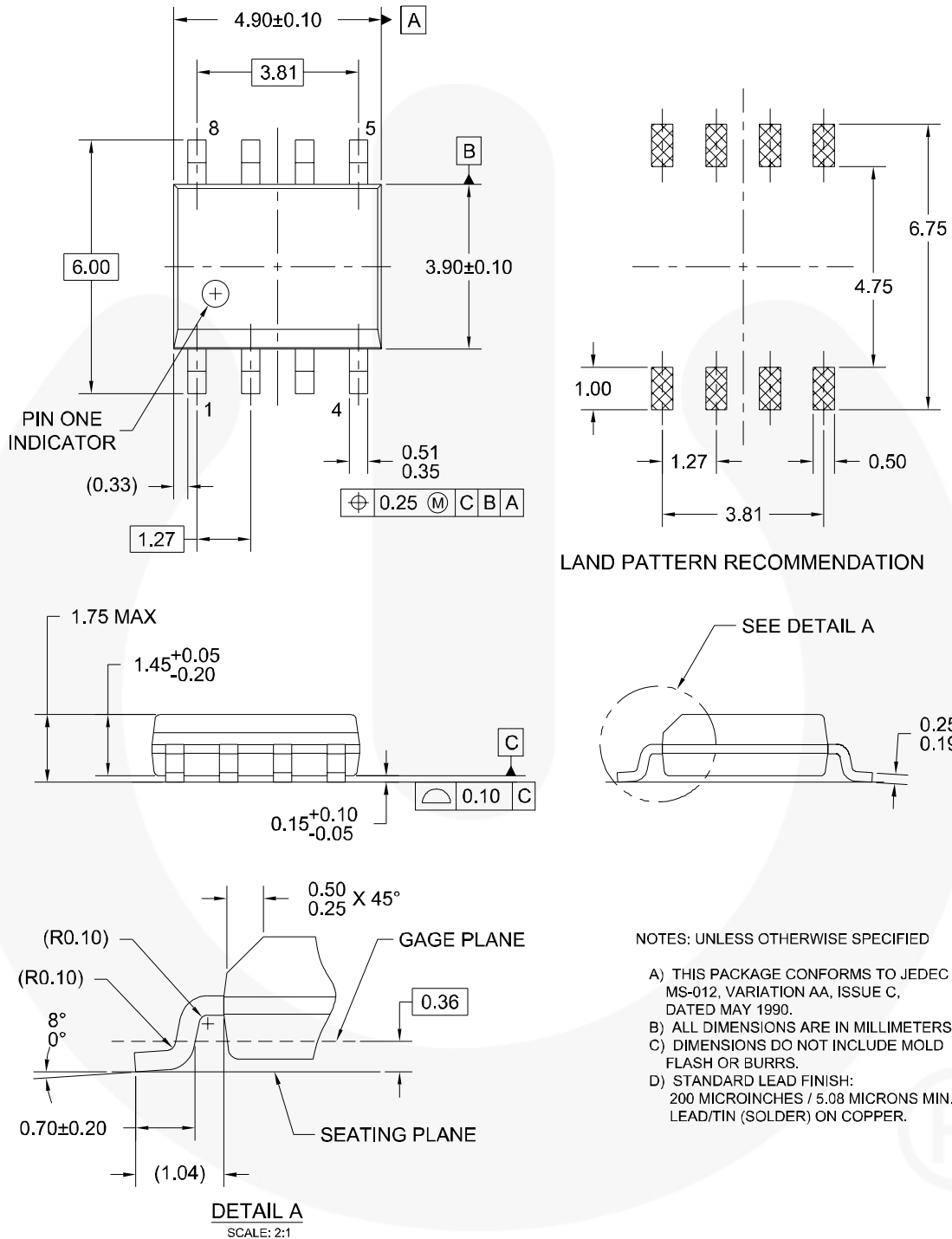

Figure 21. Recommended Layout for SOIC-8 Package (Not to Scale)

### Physical Dimensions

Dimensions are in millimeters unless otherwise noted.



M08AREVK

Figure 22. 8-Lead SOIC Package, 0.150



**TRADEMARKS**

The following are registered and unregistered trademarks and service marks Fairchild Semiconductor owns or is authorized to use and is not intended to be an exhaustive list of all such trademarks.

- |                                      |  |  |                                  |
|--------------------------------------|--|--|----------------------------------|
| ACEX <sup>®</sup>                    | Green FPS <sup>™</sup>   | Power247 <sup>®</sup>                  | SuperSOT <sup>™</sup> -8         |
| Build it Now <sup>™</sup>            | Green FPS <sup>™</sup> e-Series <sup>™</sup>   | POWEREDGE <sup>®</sup>                 | SyncFET <sup>™</sup>             |
| CorePLUS <sup>™</sup>                | GTO <sup>™</sup>   | Power-SPM <sup>™</sup>                 | The Power Franchise <sup>®</sup> |
| CROSSVOLT <sup>™</sup>               | i-Lo <sup>™</sup>  | PowerTrench <sup>®</sup>               | the power franchise              |
| CTL <sup>™</sup>                     | IntelliMAX <sup>™</sup>  | Programmable Active Droop <sup>™</sup> | TinyBoost <sup>™</sup>           |
| Current Transfer Logic <sup>™</sup>  | ISOPLANAR <sup>™</sup>   | QFET <sup>®</sup>                      | TinyBuck <sup>™</sup>            |
| EcoSPARK <sup>®</sup>                | MegaBuck <sup>™</sup>  | QS <sup>™</sup>                        | TinyLogic <sup>®</sup>           |
| <b>F</b> <sup>®</sup>                | MICROCOUPLER <sup>™</sup>  | QT Optoelectronics <sup>™</sup>        | TINYOPTO <sup>™</sup>            |
| Fairchild <sup>®</sup>               | MicroFET <sup>™</sup>  | Quiet Series <sup>™</sup>              | TinyPower <sup>™</sup>           |
| Fairchild Semiconductor <sup>®</sup> | MicroPak <sup>™</sup>  | RapidConfigure <sup>™</sup>            | TinyPWM <sup>™</sup>             |
| FACT Quiet Series <sup>™</sup>       | Motion-SPM <sup>™</sup>  | SMART START <sup>™</sup>               | TinyWire <sup>™</sup>            |
| FACT <sup>®</sup>                    | OPTOLOGIC <sup>®</sup>   | SPM <sup>®</sup>                       | μSerDes <sup>™</sup>             |
| FAST <sup>®</sup>                    | OPTOPLANAR <sup>®</sup>  | STEALTH <sup>™</sup>                   | UHC <sup>®</sup>                 |
| FastvCore <sup>™</sup>               |  <sup>®</sup> | SuperFET <sup>™</sup>                  | UniFET <sup>™</sup>              |
| FPS <sup>™</sup>                     | PDP-SPM <sup>™</sup>   | SuperSOT <sup>™</sup> -3               | VCX <sup>™</sup>                 |
| FRFET <sup>®</sup>                   | Power220 <sup>®</sup>  | SuperSOT <sup>™</sup> -6               |                                  |
| Global Power Resource <sup>SM</sup>  |  |  |                                  |

**DISCLAIMER**

FAIRCHILD SEMICONDUCTOR RESERVES THE RIGHT TO MAKE CHANGES WITHOUT FURTHER NOTICE TO ANY PRODUCTS HEREIN TO IMPROVE RELIABILITY, FUNCTION, OR DESIGN. FAIRCHILD DOES NOT ASSUME ANY LIABILITY ARISING OUT OF THE APPLICATION OR USE OF ANY PRODUCT OR CIRCUIT DESCRIBED HEREIN; NEITHER DOES IT CONVEY ANY LICENSE UNDER ITS PATENT RIGHTS, NOR THE RIGHTS OF OTHERS. THESE SPECIFICATIONS DO NOT EXPAND THE TERMS OF FAIRCHILD'S WORLDWIDE TERMS AND CONDITIONS, SPECIFICALLY THE WARRANTY THEREIN, WHICH COVERS THESE PRODUCTS.

**LIFE SUPPORT POLICY**

FAIRCHILD'S PRODUCTS ARE NOT AUTHORIZED FOR USE AS CRITICAL COMPONENTS IN LIFE SUPPORT DEVICES OR SYSTEMS WITHOUT THE EXPRESS WRITTEN APPROVAL OF FAIRCHILD SEMICONDUCTOR CORPORATION.

As used herein:

- Life support devices or systems are devices or systems which, (a) are intended for surgical implant into the body, or (b) support or sustain life, and (c) whose failure to perform when properly used in accordance with instructions for use provided in the labeling, can be reasonably expected to result in significant injury to the user.
- A critical component is any component of a life support device or system whose failure to perform can be reasonably expected to cause the failure of the life support device or system, or to affect its safety or effectiveness.

**PRODUCT STATUS DEFINITIONS**

**Definition of Terms**

Datasheet Identification	Product Status	Definition
Advance Information	Formative or In Design	This datasheet contains the design specifications for product development. Specifications may change in any manner without notice.
Preliminary	First Production	This datasheet contains preliminary data; supplementary data will be published at a later date. Fairchild Semiconductor reserves the right to make changes at any time without notice to improve design.
No Identification Needed	Full Production	This datasheet contains final specifications. Fairchild Semiconductor reserves the right to make changes at any time without notice to improve design.
Obsolete	Not In Production	This datasheet contains specifications on a product that has been discontinued by Fairchild semiconductor. The datasheet is printed for reference information only.

Rev. 130

## Looking for pricing, stock, or lifecycle information?

Click below to explore more details on WIN SOURCE:

- ⊖ [View FAN5109BMX on WIN SOURCE](#)
- ⊖ [Fairchild/ON Semiconductor Information](#)

## Optimize Your Supply Chain with WIN SOURCE Solutions

- ✓ Global Sourcing Solution
- ✓ Obsolete Management
- ✓ Cost Control Management
- ✓ Shortage Management
- ✓ Alternative Solution
- ✓ Excess Inventory Management