



## Features

- Formerly a **KEKOVARICON** product
- Six model sizes available - 0603, 0805, 1206, 1210, 1812, 2220
- Broad range of current and energy handling capabilities
- Short response time
- Low clamping voltage -  $V_C$
- Low sensitivity to mildly activated fluxes
- +125 °C maximum continuous operating temperature
- RoHS compliant\*

## ZV SMD Series - Low Voltage Varistors

### General Information

The ZV series of low voltage multilayered varistors is designed to protect sensitive electronic devices against high voltage surges in the low voltage region. They offer excellent transient energy absorption due to improved energy volume distribution and power dissipation. Low voltage varistors cover a wide DC operating voltage range from 3 V to 170 V.

In addition, the ZV series exhibits independent suppression characteristics enabling stable protection over a wide temperature range of -55 to +125 °C.

ZV varistors are typically applied to protect integrated circuits and other components at the circuit board level.

### Absolute Maximum Ratings

| Parameter                                                            | Value         | Units |
|----------------------------------------------------------------------|---------------|-------|
| <b>Continuous:</b>                                                   |               |       |
| Steady State Applied Voltage                                         |               |       |
| DC Voltage Range ( $V_{dc}$ )                                        | 3 to 170**    | V     |
| AC Voltage Range ( $V_{rms}$ )                                       | 2 to 130***   | V     |
| <b>Transient:</b>                                                    |               |       |
| Peak Single Pulse Surge Current, 8/20 $\mu$ s Waveform ( $I_{max}$ ) | 30 to 1200    | A     |
| Single Pulse Surge Energy, 10/1000 $\mu$ s Waveform ( $W_{max}$ )    | 0.1 to 12.2   | J     |
| Operating Ambient Temperature                                        | -55 to +125   | °C    |
| Storage Temperature Range                                            | -55 to +150   | °C    |
| Threshold Voltage Temperature Coefficient                            | < +0.05       | %/°C  |
| Response Time                                                        | < 2           | ns    |
| Climatic Category                                                    | 55 / 125 / 56 |       |

\*\* Varistors with rated voltages of 2 - 6  $V_{ac}$  (or 3 - 8  $V_{dc}$ ) are non-standard parts available upon request only.

\*\*\* Varistors with rated voltages of 2, 4 or 6  $V_{ac}$  (or 3 - 8  $V_{dc}$ ) are non-standard parts available upon request only.



**Asia-Pacific:** Tel: +886-2 2562-4117 • Email: [asiacus@bourns.com](mailto:asiacus@bourns.com)

**EMEA:** Tel: +36 88 885 877 • Email: [eurocus@bourns.com](mailto:eurocus@bourns.com)

**The Americas:** Tel: +1-951 781-5500 • Email: [americus@bourns.com](mailto:americus@bourns.com)

[www.bourns.com](http://www.bourns.com)

### Additional Information

Click these links for more information:



[PRODUCT SELECTOR](#) [TECHNICAL LIBRARY](#) [INVENTORY](#) [SAMPLES](#) [CONTACT](#)

### Multilayered Varistor Symbol

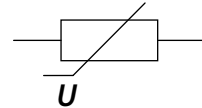

### Index

|                                                       |                       |
|-------------------------------------------------------|-----------------------|
| Features .....                                        | <a href="#">1</a>     |
| General Information .....                             | <a href="#">1</a>     |
| MLV Symbol .....                                      | <a href="#">1</a>     |
| Absolute Maximum Ratings .....                        | <a href="#">1</a>     |
| Applications .....                                    | <a href="#">2-3</a>   |
| Device Ratings .....                                  | <a href="#">2-3</a>   |
| Product Dimensions .....                              | <a href="#">4-6</a>   |
| Protection Level/<br>Pulse Rating Curves .....        | <a href="#">7-13</a>  |
| Soldering Pad Configuration .....                     | <a href="#">14</a>    |
| Packaging Specifications .....                        | <a href="#">14-15</a> |
| Soldering Recommendations for<br>SMD Components ..... | <a href="#">16-19</a> |
| Reliability - Lifetime .....                          | <a href="#">19</a>    |
| Reliability Testing Procedures .....                  | <a href="#">20-21</a> |
| How to Order .....                                    | <a href="#">21</a>    |
| Typical Part Marking .....                            | <a href="#">21</a>    |
| Terminology .....                                     | <a href="#">22</a>    |
| Legal Disclaimer .....                                | <a href="#">23</a>    |



**WARNING Cancer and Reproductive Harm - [www.P65Warnings.ca.gov](http://www.P65Warnings.ca.gov)**

\*RoHS Directive 2015/863, Mar 31, 2015 and Annex.  
Specifications are subject to change without notice.

Users should verify actual device performance in their specific applications.

The products described herein and this document are subject to specific legal disclaimers as set forth on the last page of this document, and at [www.bourns.com/docs/legal/disclaimer.pdf](http://www.bourns.com/docs/legal/disclaimer.pdf).

## Applications

- Suppression of inductive switching or other transient events such as surge voltage at the circuit board level
- ESD protection to IEC 1000-4-2, MIL-STD 883C Method 3015.7 and other industry specifications
- Replaces larger surface mount TVS Zener Diodes in many applications
- Electromagnetic compliance of end products
- On-board transient voltage protection of ICs and transistors

## ZV SMD Series – Low Voltage Varistors

**BOURNS®**

### Device Ratings

| Model            | V <sub>rms</sub> | V <sub>dc</sub> | V <sub>n</sub><br>@ 1 mA | V <sub>c</sub> | I <sub>c</sub><br>8/20 μs | W <sub>max</sub><br>10/1000 μs | P<br>max. | I <sub>max</sub><br>8/20 μs | C <sub>typ</sub><br>@ 1 kHz | I <sub>typ</sub><br>100 mA/ns |
|------------------|------------------|-----------------|--------------------------|----------------|---------------------------|--------------------------------|-----------|-----------------------------|-----------------------------|-------------------------------|
|                  | V                | V               | V                        | V              | A                         | J                              | W         | A                           | pF                          | nF                            |
| ZV 2 M 0603 300  | 2                | 3               | 4                        | 10             | 1                         | 0.1                            | 0.003     | 30                          | 360                         | 1.0                           |
| ZV 2 M 0805 101  | 2                | 3               | 4                        | 10             | 1                         | 0.1                            | 0.005     | 100                         | 930                         | 1.5                           |
| ZV 2 M 1206 151  | 2                | 3               | 4                        | 10             | 1                         | 0.2                            | 0.008     | 150                         | 4000                        | 1.8                           |
| ZV 4 M 0603 300  | 4                | 5.5             | 8                        | 14             | 1                         | 0.1                            | 0.003     | 30                          | 295                         | 1.0                           |
| ZV 4 M 0805 101  | 4                | 5.5             | 8                        | 14             | 1                         | 0.1                            | 0.005     | 100                         | 695                         | 1.5                           |
| ZV 4 M 1206 151  | 4                | 5.5             | 8                        | 14             | 1                         | 0.3                            | 0.008     | 150                         | 3300                        | 1.8                           |
| ZV 4 M 1210 251  | 4                | 5.5             | 8                        | 14             | 3                         | 0.4                            | 0.010     | 250                         | 5000                        | 1.8                           |
| ZV 4 M 1812 501  | 4                | 5.5             | 8                        | 14             | 5                         | 0.8                            | 0.015     | 500                         | 10000                       | 2.5                           |
| ZV 4 M 2220 102  | 4                | 5.5             | 8                        | 14             | 10                        | 1.5                            | 0.020     | 1000                        | 19500                       | 3.0                           |
| ZV 6 M 0603 300  | 6                | 8               | 11                       | 21             | 1                         | 0.1                            | 0.003     | 30                          | 260                         | 1.0                           |
| ZV 6 M 0805 101  | 6                | 8               | 11                       | 21             | 1                         | 0.2                            | 0.005     | 100                         | 560                         | 1.5                           |
| ZV 6 M 1206 151  | 6                | 8               | 11                       | 21             | 1                         | 0.5                            | 0.008     | 150                         | 2600                        | 1.8                           |
| ZV 6 M 1210 301  | 6                | 8               | 11                       | 21             | 3                         | 0.8                            | 0.010     | 300                         | 4100                        | 1.8                           |
| ZV 6 M 1812 501  | 6                | 8               | 11                       | 21             | 5                         | 1.0                            | 0.015     | 500                         | 7500                        | 2.5                           |
| ZV 6 M 2220 122  | 6                | 8               | 11                       | 21             | 10                        | 3.8                            | 0.020     | 1200                        | 17000                       | 3.0                           |
| ZV 8 L 0603 300  | 8                | 11              | 15                       | 25             | 1                         | 0.1                            | 0.003     | 30                          | 240                         | 1.0                           |
| ZV 8 L 0805 121  | 8                | 11              | 15                       | 25             | 1                         | 0.2                            | 0.005     | 120                         | 475                         | 1.5                           |
| ZV 8 L 1206 201  | 8                | 11              | 15                       | 25             | 1                         | 0.6                            | 0.008     | 200                         | 2000                        | 1.8                           |
| ZV 8 L 1210 401  | 8                | 11              | 15                       | 25             | 3                         | 1.1                            | 0.010     | 400                         | 3400                        | 1.8                           |
| ZV 8 L 1812 501  | 8                | 11              | 15                       | 25             | 5                         | 1.9                            | 0.015     | 500                         | 6300                        | 2.5                           |
| ZV 8 L 2220 122  | 8                | 11              | 15                       | 25             | 10                        | 4.3                            | 0.020     | 1200                        | 15000                       | 3.0                           |
| ZV 11 K 0603 300 | 11               | 14              | 18                       | 33             | 1                         | 0.2                            | 0.003     | 30                          | 210                         | 1.0                           |
| ZV 11 K 0805 121 | 11               | 14              | 18                       | 33             | 1                         | 0.3                            | 0.005     | 120                         | 400                         | 1.5                           |
| ZV 11 K 1206 201 | 11               | 14              | 18                       | 33             | 1                         | 0.6                            | 0.008     | 200                         | 1300                        | 1.8                           |
| ZV 11 K 1210 401 | 11               | 14              | 18                       | 33             | 3                         | 1.3                            | 0.010     | 400                         | 2600                        | 1.8                           |
| ZV 11 K 1812 801 | 11               | 14              | 18                       | 33             | 5                         | 2.0                            | 0.015     | 800                         | 5100                        | 2.5                           |
| ZV 11 K 2220 122 | 11               | 14              | 18                       | 33             | 10                        | 5.5                            | 0.020     | 1200                        | 12000                       | 3.0                           |
| ZV 14 K 0603 300 | 14               | 18              | 22                       | 38             | 1                         | 0.3                            | 0.003     | 30                          | 195                         | 1.0                           |
| ZV 14 K 0805 121 | 14               | 18              | 22                       | 38             | 1                         | 0.4                            | 0.005     | 120                         | 355                         | 1.5                           |
| ZV 14 K 1206 201 | 14               | 18              | 22                       | 38             | 1                         | 0.6                            | 0.008     | 200                         | 950                         | 1.8                           |
| ZV 14 K 1210 401 | 14               | 18              | 22                       | 38             | 3                         | 1.6                            | 0.010     | 400                         | 2000                        | 1.8                           |
| ZV 14 K 1812 801 | 14               | 18              | 22                       | 38             | 5                         | 2.4                            | 0.015     | 800                         | 4200                        | 2.5                           |
| ZV 14 K 2220 122 | 14               | 18              | 22                       | 38             | 10                        | 6.0                            | 0.020     | 1200                        | 9400                        | 3.0                           |
| ZV 17 K 0603 300 | 17               | 22              | 27                       | 44             | 1                         | 0.3                            | 0.003     | 30                          | 185                         | 1.0                           |
| ZV 17 K 0805 121 | 17               | 22              | 27                       | 44             | 1                         | 0.4                            | 0.005     | 120                         | 315                         | 1.5                           |
| ZV 17 K 1206 201 | 17               | 22              | 27                       | 44             | 1                         | 0.7                            | 0.008     | 200                         | 740                         | 1.8                           |
| ZV 17 K 1210 401 | 17               | 22              | 27                       | 44             | 3                         | 1.8                            | 0.010     | 400                         | 1700                        | 1.8                           |
| ZV 17 K 1812 801 | 17               | 22              | 27                       | 44             | 5                         | 2.8                            | 0.015     | 800                         | 3500                        | 2.5                           |
| ZV 17 K 2220 122 | 17               | 22              | 27                       | 44             | 10                        | 7.5                            | 0.020     | 1200                        | 7700                        | 3.0                           |
| ZV 20 K 0603 300 | 20               | 26              | 33                       | 54             | 1                         | 0.3                            | 0.003     | 30                          | 175                         | 1.0                           |
| ZV 20 K 0805 121 | 20               | 26              | 33                       | 54             | 1                         | 0.4                            | 0.005     | 120                         | 290                         | 1.5                           |
| ZV 20 K 1206 201 | 20               | 26              | 33                       | 54             | 1                         | 0.8                            | 0.008     | 200                         | 620                         | 1.8                           |
| ZV 20 K 1210 401 | 20               | 26              | 33                       | 54             | 3                         | 2.0                            | 0.010     | 400                         | 1400                        | 1.8                           |
| ZV 20 K 1812 801 | 20               | 26              | 33                       | 54             | 5                         | 3.0                            | 0.015     | 800                         | 3000                        | 2.5                           |
| ZV 20 K 2220 122 | 20               | 26              | 33                       | 54             | 10                        | 8.0                            | 0.020     | 1200                        | 6500                        | 3.0                           |

Specifications are subject to change without notice.

Users should verify actual device performance in their specific applications.

The products described herein and this document are subject to specific legal disclaimers as set forth on the last page of this document, and at [www.bourns.com/docs/legal/disclaimer.pdf](http://www.bourns.com/docs/legal/disclaimer.pdf).

# ZV SMD Series – Low Voltage Varistors



## Device Ratings (Continued)

| Model             | V <sub>rms</sub> | V <sub>dc</sub> | V <sub>n</sub><br>@ 1 mA | V <sub>c</sub> | I <sub>c</sub><br>8/20 μs | W <sub>max</sub><br>10/1000 μs | P<br>max. | I <sub>max</sub><br>8/20 μs | C <sub>typ</sub><br>@ 1 kHz | I <sub>typ</sub><br>100 mA/ns |
|-------------------|------------------|-----------------|--------------------------|----------------|---------------------------|--------------------------------|-----------|-----------------------------|-----------------------------|-------------------------------|
|                   | V                | V               | V                        | V              | A                         | J                              | W         | A                           | pF                          | nF                            |
| ZV 25 K 0603 300  | 25               | 31              | 39                       | 65             | 1                         | 0.1                            | 0.003     | 30                          | 165                         | 1.0                           |
| ZV 25 K 0805 121  | 25               | 31              | 39                       | 65             | 1                         | 0.2                            | 0.005     | 120                         | 260                         | 1.5                           |
| ZV 25 K 1206 201  | 25               | 31              | 39                       | 65             | 1                         | 1.0                            | 0.008     | 200                         | 510                         | 1.8                           |
| ZV 25 K 1210 401  | 25               | 31              | 39                       | 65             | 3                         | 1.8                            | 0.010     | 400                         | 1060                        | 1.8                           |
| ZV 25 K 1812 801  | 25               | 31              | 39                       | 65             | 5                         | 3.9                            | 0.015     | 800                         | 2300                        | 2.5                           |
| ZV 25 K 2220 122  | 25               | 31              | 39                       | 65             | 10                        | 9.5                            | 0.020     | 1200                        | 5000                        | 3.0                           |
| ZV 30 K 0603 300  | 30               | 38              | 47                       | 77             | 1                         | 0.1                            | 0.003     | 30                          | 160                         | 1.0                           |
| ZV 30 K 0805 121  | 30               | 38              | 47                       | 77             | 1                         | 0.2                            | 0.005     | 120                         | 230                         | 1.5                           |
| ZV 30 K 1206 201  | 30               | 38              | 47                       | 77             | 1                         | 1.2                            | 0.008     | 200                         | 450                         | 1.8                           |
| ZV 30 K 1210 301  | 30               | 38              | 47                       | 77             | 3                         | 2.1                            | 0.010     | 300                         | 850                         | 1.8                           |
| ZV 30 K 1812 801  | 30               | 38              | 47                       | 77             | 5                         | 4.4                            | 0.015     | 800                         | 1800                        | 2.5                           |
| ZV 30 K 2220 122  | 30               | 38              | 47                       | 77             | 10                        | 12.2                           | 0.020     | 1200                        | 4000                        | 3.0                           |
| ZV 35 K 1206 121  | 35               | 45              | 56                       | 90             | 1                         | 0.6                            | 0.008     | 120                         | 400                         | 1.8                           |
| ZV 35 K 1210 251  | 35               | 45              | 56                       | 90             | 3                         | 2.2                            | 0.010     | 250                         | 670                         | 1.8                           |
| ZV 35 K 1812 601  | 35               | 45              | 56                       | 90             | 5                         | 4.2                            | 0.015     | 600                         | 1340                        | 2.5                           |
| ZV 35 K 2220 102  | 35               | 45              | 56                       | 90             | 10                        | 7.6                            | 0.020     | 1000                        | 3000                        | 3.0                           |
| ZV 40 K 1206 121  | 40               | 56              | 68                       | 110            | 1                         | 0.8                            | 0.008     | 120                         | 370                         | 1.8                           |
| ZV 40 K 1210 251  | 40               | 56              | 68                       | 110            | 3                         | 2.4                            | 0.010     | 250                         | 570                         | 1.8                           |
| ZV 40 K 1812 601  | 40               | 56              | 68                       | 110            | 5                         | 4.8                            | 0.015     | 600                         | 1000                        | 2.5                           |
| ZV 40 K 2220 102  | 40               | 56              | 68                       | 110            | 10                        | 9.2                            | 0.020     | 1000                        | 2200                        | 3.0                           |
| ZV 50 K 1206 121  | 50               | 65              | 82                       | 135            | 1                         | 0.8                            | 0.008     | 120                         | 340                         | 1.8                           |
| ZV 50 K 1210 251  | 50               | 65              | 82                       | 135            | 3                         | 1.7                            | 0.010     | 250                         | 470                         | 1.8                           |
| ZV 50 K 1812 401  | 50               | 65              | 82                       | 135            | 5                         | 4.8                            | 0.015     | 400                         | 710                         | 2.5                           |
| ZV 50 K 2220 801  | 50               | 65              | 82                       | 135            | 10                        | 5.8                            | 0.020     | 800                         | 1500                        | 3.0                           |
| ZV 60 K 1206 121  | 60               | 85              | 100                      | 165            | 1                         | 0.9                            | 0.008     | 120                         | 330                         | 1.8                           |
| ZV 60 K 1210 251  | 60               | 85              | 100                      | 165            | 3                         | 2.2                            | 0.010     | 250                         | 390                         | 1.8                           |
| ZV 60 K 1812 401  | 60               | 85              | 100                      | 165            | 5                         | 5.8                            | 0.015     | 400                         | 580                         | 2.5                           |
| ZV 60 K 2220 801  | 60               | 85              | 100                      | 165            | 10                        | 6.2                            | 0.020     | 800                         | 1000                        | 3.0                           |
| ZV 75 K 1206 121  | 75               | 100             | 120                      | 200            | 1                         | 0.9                            | 0.008     | 120                         | 240                         | 1.8                           |
| ZV 75 K 1210 251  | 75               | 100             | 120                      | 200            | 3                         | 2.2                            | 0.010     | 250                         | 330                         | 1.8                           |
| ZV 75 K 1812 401  | 75               | 100             | 120                      | 200            | 5                         | 5.8                            | 0.015     | 400                         | 440                         | 2.5                           |
| ZV 75 K 2220 801  | 75               | 100             | 120                      | 200            | 10                        | 6.2                            | 0.020     | 800                         | 700                         | 3.0                           |
| ZV 95 K 1210 201  | 95               | 125             | 150                      | 250            | 3                         | 2.6                            | 0.010     | 200                         | 240                         | 1.8                           |
| ZV 95 K 1812 301  | 95               | 125             | 150                      | 250            | 5                         | 5.2                            | 0.015     | 300                         | 340                         | 2.5                           |
| ZV 95 K 2220 501  | 95               | 125             | 150                      | 250            | 10                        | 7.4                            | 0.020     | 500                         | 600                         | 3.0                           |
| ZV 115 K 1210 201 | 115              | 150             | 180                      | 300            | 3                         | 2.6                            | 0.010     | 200                         | 200                         | 1.8                           |
| ZV 115 K 1812 301 | 115              | 150             | 180                      | 300            | 5                         | 5.2                            | 0.015     | 300                         | 310                         | 2.5                           |
| ZV 115 K 2220 501 | 115              | 150             | 180                      | 300            | 10                        | 7.4                            | 0.020     | 500                         | 560                         | 3.0                           |
| ZV 130 K 1210 201 | 130              | 170             | 205                      | 340            | 3                         | 2.6                            | 0.010     | 200                         | 150                         | 1.8                           |
| ZV 130 K 1812 301 | 130              | 170             | 205                      | 340            | 5                         | 5.2                            | 0.015     | 300                         | 240                         | 2.5                           |
| ZV 130 K 2220 501 | 130              | 170             | 205                      | 340            | 10                        | 7.4                            | 0.020     | 500                         | 500                         | 3.0                           |

Specifications are subject to change without notice.

Users should verify actual device performance in their specific applications.

The products described herein and this document are subject to specific legal disclaimers as set forth on the last page of this document, and at [www.bourns.com/docs/legal/disclaimer.pdf](http://www.bourns.com/docs/legal/disclaimer.pdf).

# ZV SMD Series – Low Voltage Varistors



## Product Dimensions

| Model            | Dimension                              |                                         |                       |
|------------------|----------------------------------------|-----------------------------------------|-----------------------|
|                  | L                                      | W                                       | t (Max.)              |
| ZV 2 M 0603 300  | $\frac{1.6 \pm 0.20}{(.063 \pm .008)}$ | $\frac{0.80 \pm 0.10}{(.031 \pm .004)}$ | $\frac{0.95}{(.037)}$ |
| ZV 2 M 0805 101  | $\frac{2.0 \pm 0.25}{(.079 \pm .010)}$ | $\frac{1.25 \pm 0.20}{(.049 \pm .008)}$ | $\frac{0.80}{(.031)}$ |
| ZV 2 M 1206 151  | $\frac{3.2 \pm 0.30}{(.126 \pm .012)}$ | $\frac{1.60 \pm 0.20}{(.063 \pm .008)}$ | $\frac{0.85}{(.033)}$ |
| ZV 4 M 0603 300  | $\frac{1.6 \pm 0.20}{(.063 \pm .008)}$ | $\frac{0.80 \pm 0.10}{(.031 \pm .004)}$ | $\frac{0.95}{(.037)}$ |
| ZV 4 M 0805 101  | $\frac{2.0 \pm 0.25}{(.079 \pm .010)}$ | $\frac{1.25 \pm 0.20}{(.049 \pm .008)}$ | $\frac{0.80}{(.031)}$ |
| ZV 4 M 1206 151  | $\frac{3.2 \pm 0.30}{(.126 \pm .012)}$ | $\frac{1.60 \pm 0.20}{(.063 \pm .008)}$ | $\frac{0.85}{(.033)}$ |
| ZV 4 M 1210 251  | $\frac{3.2 \pm 0.30}{(.126 \pm .012)}$ | $\frac{2.50 \pm 0.25}{(.098 \pm .010)}$ | $\frac{0.85}{(.033)}$ |
| ZV 4 M 1812 501  | $\frac{4.7 \pm 0.40}{(.185 \pm .016)}$ | $\frac{3.2 \pm 0.30}{(.126 \pm .012)}$  | $\frac{1.25}{(.049)}$ |
| ZV 4 M 2220 102  | $\frac{5.7 \pm 0.50}{(.224 \pm .020)}$ | $\frac{5.00 \pm 0.40}{(.197 \pm .016)}$ | $\frac{1.25}{(.049)}$ |
| ZV 6 M 0603 300  | $\frac{1.6 \pm 0.20}{(.063 \pm .008)}$ | $\frac{0.80 \pm 0.10}{(.031 \pm .004)}$ | $\frac{0.95}{(.037)}$ |
| ZV 6 M 0805 101  | $\frac{2.0 \pm 0.25}{(.079 \pm .010)}$ | $\frac{1.25 \pm 0.20}{(.049 \pm .008)}$ | $\frac{0.80}{(.031)}$ |
| ZV 6 M 1206 151  | $\frac{3.2 \pm 0.30}{(.126 \pm .012)}$ | $\frac{1.60 \pm 0.20}{(.063 \pm .008)}$ | $\frac{0.85}{(.033)}$ |
| ZV 6 M 1210 301  | $\frac{3.2 \pm 0.30}{(.126 \pm .012)}$ | $\frac{2.50 \pm 0.25}{(.098 \pm .010)}$ | $\frac{0.85}{(.033)}$ |
| ZV 6 M 1812 501  | $\frac{4.7 \pm 0.40}{(.185 \pm .016)}$ | $\frac{3.2 \pm 0.30}{(.126 \pm .012)}$  | $\frac{1.25}{(.049)}$ |
| ZV 6 M 2220 122  | $\frac{5.7 \pm 0.50}{(.224 \pm .020)}$ | $\frac{5.00 \pm 0.40}{(.197 \pm .016)}$ | $\frac{1.25}{(.049)}$ |
| ZV 8 L 0603 300  | $\frac{1.6 \pm 0.20}{(.063 \pm .008)}$ | $\frac{0.80 \pm 0.10}{(.031 \pm .004)}$ | $\frac{0.95}{(.037)}$ |
| ZV 8 L 0805 121  | $\frac{2.0 \pm 0.25}{(.079 \pm .010)}$ | $\frac{1.25 \pm 0.20}{(.049 \pm .008)}$ | $\frac{0.80}{(.031)}$ |
| ZV 8 L 1206 201  | $\frac{3.2 \pm 0.30}{(.126 \pm .012)}$ | $\frac{1.60 \pm 0.20}{(.063 \pm .008)}$ | $\frac{0.85}{(.033)}$ |
| ZV 8 L 1210 401  | $\frac{3.2 \pm 0.30}{(.126 \pm .012)}$ | $\frac{2.50 \pm 0.25}{(.098 \pm .010)}$ | $\frac{0.85}{(.033)}$ |
| ZV 8 L 1812 501  | $\frac{4.7 \pm 0.40}{(.185 \pm .016)}$ | $\frac{3.2 \pm 0.30}{(.126 \pm .012)}$  | $\frac{1.25}{(.049)}$ |
| ZV 8 L 2220 122  | $\frac{5.7 \pm 0.50}{(.224 \pm .020)}$ | $\frac{5.00 \pm 0.40}{(.197 \pm .016)}$ | $\frac{1.25}{(.049)}$ |
| ZV 11 K 0603 300 | $\frac{1.6 \pm 0.20}{(.063 \pm .008)}$ | $\frac{0.80 \pm 0.10}{(.031 \pm .004)}$ | $\frac{0.95}{(.037)}$ |
| ZV 11 K 0805 121 | $\frac{2.0 \pm 0.25}{(.079 \pm .010)}$ | $\frac{1.25 \pm 0.20}{(.049 \pm .008)}$ | $\frac{0.80}{(.031)}$ |
| ZV 11 K 1206 201 | $\frac{3.2 \pm 0.30}{(.126 \pm .012)}$ | $\frac{1.60 \pm 0.20}{(.063 \pm .008)}$ | $\frac{0.85}{(.033)}$ |
| ZV 11 K 1210 401 | $\frac{3.2 \pm 0.30}{(.126 \pm .012)}$ | $\frac{2.50 \pm 0.25}{(.098 \pm .010)}$ | $\frac{0.85}{(.033)}$ |
| ZV 11 K 1812 801 | $\frac{4.7 \pm 0.40}{(.185 \pm .016)}$ | $\frac{3.2 \pm 0.30}{(.126 \pm .012)}$  | $\frac{1.25}{(.049)}$ |
| ZV 11 K 2220 122 | $\frac{5.7 \pm 0.50}{(.224 \pm .020)}$ | $\frac{5.00 \pm 0.40}{(.197 \pm .016)}$ | $\frac{1.25}{(.049)}$ |
| ZV 14 K 0603 300 | $\frac{1.6 \pm 0.20}{(.063 \pm .008)}$ | $\frac{0.80 \pm 0.10}{(.031 \pm .004)}$ | $\frac{0.95}{(.037)}$ |
| ZV 14 K 0805 121 | $\frac{2.0 \pm 0.25}{(.079 \pm .010)}$ | $\frac{1.25 \pm 0.20}{(.049 \pm .008)}$ | $\frac{0.80}{(.031)}$ |
| ZV 14 K 1206 201 | $\frac{3.2 \pm 0.30}{(.126 \pm .012)}$ | $\frac{1.60 \pm 0.20}{(.063 \pm .008)}$ | $\frac{0.85}{(.033)}$ |
| ZV 14 K 1210 401 | $\frac{3.2 \pm 0.30}{(.126 \pm .012)}$ | $\frac{2.50 \pm 0.25}{(.098 \pm .010)}$ | $\frac{0.85}{(.033)}$ |
| ZV 14 K 1812 801 | $\frac{4.7 \pm 0.40}{(.185 \pm .016)}$ | $\frac{3.2 \pm 0.30}{(.126 \pm .012)}$  | $\frac{1.25}{(.049)}$ |
| ZV 14 K 2220 122 | $\frac{5.7 \pm 0.50}{(.224 \pm .020)}$ | $\frac{5.00 \pm 0.40}{(.197 \pm .016)}$ | $\frac{1.25}{(.049)}$ |

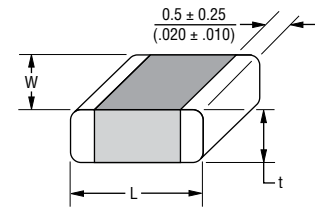

DIMENSIONS:  $\frac{\text{MM}}{\text{(INCHES)}}$

Specifications are subject to change without notice.

Users should verify actual device performance in their specific applications.

The products described herein and this document are subject to specific legal disclaimers as set forth on the last page of this document, and at [www.bourns.com/docs/legal/disclaimer.pdf](http://www.bourns.com/docs/legal/disclaimer.pdf).

# ZV SMD Series – Low Voltage Varistors



## Product Dimensions (Continued)

| Model            | Dimension                              |                                         |                       |
|------------------|----------------------------------------|-----------------------------------------|-----------------------|
|                  | L                                      | W                                       | t (Max.)              |
| ZV 17 K 0603 300 | $\frac{1.6 \pm 0.20}{(.063 \pm .008)}$ | $\frac{0.80 \pm 0.10}{(.031 \pm .004)}$ | $\frac{0.95}{(.037)}$ |
| ZV 17 K 0805 121 | $\frac{2.0 \pm 0.25}{(.079 \pm .010)}$ | $\frac{1.25 \pm 0.20}{(.049 \pm .008)}$ | $\frac{0.80}{(.031)}$ |
| ZV 17 K 1206 201 | $\frac{3.2 \pm 0.30}{(.126 \pm .012)}$ | $\frac{1.60 \pm 0.20}{(.063 \pm .008)}$ | $\frac{0.85}{(.033)}$ |
| ZV 17 K 1210 401 | $\frac{3.2 \pm 0.30}{(.126 \pm .012)}$ | $\frac{2.50 \pm 0.25}{(.098 \pm .010)}$ | $\frac{0.85}{(.033)}$ |
| ZV 17 K 1812 801 | $\frac{4.7 \pm 0.40}{(.185 \pm .016)}$ | $\frac{3.2 \pm 0.30}{(.126 \pm .012)}$  | $\frac{1.25}{(.049)}$ |
| ZV 17 K 2220 122 | $\frac{5.7 \pm 0.50}{(.224 \pm .020)}$ | $\frac{5.00 \pm 0.40}{(.197 \pm .016)}$ | $\frac{1.25}{(.049)}$ |
| ZV 20 K 0603 300 | $\frac{1.6 \pm 0.20}{(.063 \pm .008)}$ | $\frac{0.80 \pm 0.10}{(.031 \pm .004)}$ | $\frac{0.95}{(.037)}$ |
| ZV 20 K 0805 121 | $\frac{2.0 \pm 0.25}{(.079 \pm .010)}$ | $\frac{1.25 \pm 0.20}{(.049 \pm .008)}$ | $\frac{1.05}{(.041)}$ |
| ZV 20 K 1206 201 | $\frac{3.2 \pm 0.30}{(.126 \pm .012)}$ | $\frac{1.60 \pm 0.20}{(.063 \pm .008)}$ | $\frac{1.25}{(.049)}$ |
| ZV 20 K 1210 401 | $\frac{3.2 \pm 0.30}{(.126 \pm .012)}$ | $\frac{2.50 \pm 0.25}{(.098 \pm .010)}$ | $\frac{1.35}{(.053)}$ |
| ZV 20 K 1812 801 | $\frac{4.7 \pm 0.40}{(.185 \pm .016)}$ | $\frac{3.2 \pm 0.30}{(.126 \pm .012)}$  | $\frac{1.55}{(.061)}$ |
| ZV 20 K 2220 122 | $\frac{5.7 \pm 0.50}{(.224 \pm .020)}$ | $\frac{5.00 \pm 0.40}{(.197 \pm .016)}$ | $\frac{1.45}{(.057)}$ |
| ZV 25 K 0603 300 | $\frac{1.6 \pm 0.20}{(.063 \pm .008)}$ | $\frac{0.80 \pm 0.10}{(.031 \pm .004)}$ | $\frac{0.95}{(.037)}$ |
| ZV 25 K 0805 121 | $\frac{2.0 \pm 0.25}{(.079 \pm .010)}$ | $\frac{1.25 \pm 0.20}{(.049 \pm .008)}$ | $\frac{1.05}{(.041)}$ |
| ZV 25 K 1206 201 | $\frac{3.2 \pm 0.30}{(.126 \pm .012)}$ | $\frac{1.60 \pm 0.20}{(.063 \pm .008)}$ | $\frac{1.25}{(.049)}$ |
| ZV 25 K 1210 401 | $\frac{3.2 \pm 0.30}{(.126 \pm .012)}$ | $\frac{2.50 \pm 0.25}{(.098 \pm .010)}$ | $\frac{1.45}{(.057)}$ |
| ZV 25 K 1812 801 | $\frac{4.7 \pm 0.40}{(.185 \pm .016)}$ | $\frac{3.2 \pm 0.30}{(.126 \pm .012)}$  | $\frac{1.55}{(.061)}$ |
| ZV 25 K 2220 122 | $\frac{5.7 \pm 0.50}{(.224 \pm .020)}$ | $\frac{5.00 \pm 0.40}{(.197 \pm .016)}$ | $\frac{1.45}{(.057)}$ |
| ZV 30 K 0603 300 | $\frac{1.6 \pm 0.20}{(.063 \pm .008)}$ | $\frac{0.80 \pm 0.10}{(.031 \pm .004)}$ | $\frac{0.95}{(.037)}$ |
| ZV 30 K 0805 121 | $\frac{2.0 \pm 0.25}{(.079 \pm .010)}$ | $\frac{1.25 \pm 0.20}{(.049 \pm .008)}$ | $\frac{1.05}{(.041)}$ |
| ZV 30 K 1206 201 | $\frac{3.2 \pm 0.30}{(.126 \pm .012)}$ | $\frac{1.60 \pm 0.20}{(.063 \pm .008)}$ | $\frac{1.25}{(.049)}$ |
| ZV 30 K 1210 301 | $\frac{3.2 \pm 0.30}{(.126 \pm .012)}$ | $\frac{2.50 \pm 0.25}{(.098 \pm .010)}$ | $\frac{1.45}{(.057)}$ |
| ZV 30 K 1812 801 | $\frac{4.7 \pm 0.40}{(.185 \pm .016)}$ | $\frac{3.2 \pm 0.30}{(.126 \pm .012)}$  | $\frac{1.55}{(.061)}$ |
| ZV 30 K 2220 122 | $\frac{5.7 \pm 0.50}{(.224 \pm .020)}$ | $\frac{5.00 \pm 0.40}{(.197 \pm .016)}$ | $\frac{1.45}{(.057)}$ |
| ZV 35 K 1206 121 | $\frac{3.2 \pm 0.30}{(.126 \pm .012)}$ | $\frac{1.60 \pm 0.20}{(.063 \pm .008)}$ | $\frac{1.25}{(.049)}$ |
| ZV 35 K 1210 251 | $\frac{3.2 \pm 0.30}{(.126 \pm .012)}$ | $\frac{2.50 \pm 0.25}{(.098 \pm .010)}$ | $\frac{1.45}{(.057)}$ |
| ZV 35 K 1812 601 | $\frac{4.7 \pm 0.40}{(.185 \pm .016)}$ | $\frac{3.2 \pm 0.30}{(.126 \pm .012)}$  | $\frac{1.55}{(.061)}$ |
| ZV 35 K 2220 102 | $\frac{5.7 \pm 0.50}{(.224 \pm .020)}$ | $\frac{5.00 \pm 0.40}{(.197 \pm .016)}$ | $\frac{1.45}{(.057)}$ |
| ZV 40 K 1206 121 | $\frac{3.2 \pm 0.30}{(.126 \pm .012)}$ | $\frac{1.60 \pm 0.20}{(.063 \pm .008)}$ | $\frac{1.25}{(.049)}$ |
| ZV 40 K 1210 251 | $\frac{3.2 \pm 0.30}{(.126 \pm .012)}$ | $\frac{2.50 \pm 0.25}{(.098 \pm .010)}$ | $\frac{1.45}{(.057)}$ |
| ZV 40 K 1812 601 | $\frac{4.7 \pm 0.40}{(.185 \pm .016)}$ | $\frac{3.2 \pm 0.30}{(.126 \pm .012)}$  | $\frac{1.55}{(.061)}$ |
| ZV 40 K 2220 102 | $\frac{5.7 \pm 0.50}{(.224 \pm .020)}$ | $\frac{5.00 \pm 0.40}{(.197 \pm .016)}$ | $\frac{1.45}{(.057)}$ |

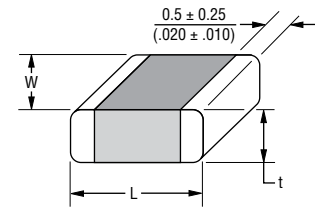

DIMENSIONS:  $\frac{\text{MM}}{\text{(INCHES)}}$

Specifications are subject to change without notice.

Users should verify actual device performance in their specific applications.

The products described herein and this document are subject to specific legal disclaimers as set forth on the last page of this document, and at [www.bourns.com/docs/legal/disclaimer.pdf](http://www.bourns.com/docs/legal/disclaimer.pdf).

# ZV SMD Series – Low Voltage Varistors



## Product Dimensions (Continued)

| Model             | Dimension                              |                                         |                       |
|-------------------|----------------------------------------|-----------------------------------------|-----------------------|
|                   | L                                      | W                                       | t (Max.)              |
| ZV 50 K 1206 121  | $\frac{3.2 \pm 0.30}{(.126 \pm .012)}$ | $\frac{1.60 \pm 0.20}{(.063 \pm .008)}$ | $\frac{1.65}{(.065)}$ |
| ZV 50 K 1210 251  | $\frac{3.2 \pm 0.30}{(.126 \pm .012)}$ | $\frac{2.50 \pm 0.25}{(.098 \pm .010)}$ | $\frac{1.75}{(.069)}$ |
| ZV 50 K 1812 401  | $\frac{4.7 \pm 0.40}{(.185 \pm .016)}$ | $\frac{3.2 \pm 0.30}{(.126 \pm .012)}$  | $\frac{1.85}{(.073)}$ |
| ZV 50 K 2220 801  | $\frac{5.7 \pm 0.50}{(.224 \pm .020)}$ | $\frac{5.00 \pm 0.40}{(.197 \pm .016)}$ | $\frac{1.85}{(.073)}$ |
| ZV 60 K 1206 121  | $\frac{3.2 \pm 0.30}{(.126 \pm .012)}$ | $\frac{1.60 \pm 0.20}{(.063 \pm .008)}$ | $\frac{1.65}{(.065)}$ |
| ZV 60 K 1210 251  | $\frac{3.2 \pm 0.30}{(.126 \pm .012)}$ | $\frac{2.50 \pm 0.25}{(.098 \pm .010)}$ | $\frac{1.75}{(.069)}$ |
| ZV 60 K 1812 401  | $\frac{4.7 \pm 0.40}{(.185 \pm .016)}$ | $\frac{3.2 \pm 0.30}{(.126 \pm .012)}$  | $\frac{1.85}{(.073)}$ |
| ZV 60 K 2220 801  | $\frac{5.7 \pm 0.50}{(.224 \pm .020)}$ | $\frac{5.00 \pm 0.40}{(.197 \pm .016)}$ | $\frac{1.85}{(.073)}$ |
| ZV 75 K 1206 121  | $\frac{3.2 \pm 0.30}{(.126 \pm .012)}$ | $\frac{1.60 \pm 0.20}{(.063 \pm .008)}$ | $\frac{1.70}{(.067)}$ |
| ZV 75 K 1210 251  | $\frac{3.2 \pm 0.30}{(.126 \pm .012)}$ | $\frac{2.50 \pm 0.25}{(.098 \pm .010)}$ | $\frac{1.80}{(.071)}$ |
| ZV 75 K 1812 401  | $\frac{4.7 \pm 0.40}{(.185 \pm .016)}$ | $\frac{3.2 \pm 0.30}{(.126 \pm .012)}$  | $\frac{1.90}{(.075)}$ |
| ZV 75 K 2220 801  | $\frac{5.7 \pm 0.50}{(.224 \pm .020)}$ | $\frac{5.00 \pm 0.40}{(.197 \pm .016)}$ | $\frac{1.90}{(.075)}$ |
| ZV 95 K 1210 201  | $\frac{3.2 \pm 0.30}{(.126 \pm .012)}$ | $\frac{2.50 \pm 0.25}{(.098 \pm .010)}$ | $\frac{1.80}{(.071)}$ |
| ZV 95 K 1812 301  | $\frac{4.7 \pm 0.40}{(.185 \pm .016)}$ | $\frac{3.2 \pm 0.30}{(.126 \pm .012)}$  | $\frac{1.90}{(.075)}$ |
| ZV 95 K 2220 501  | $\frac{5.7 \pm 0.50}{(.224 \pm .020)}$ | $\frac{5.00 \pm 0.40}{(.197 \pm .016)}$ | $\frac{1.90}{(.075)}$ |
| ZV 115 K 1210 201 | $\frac{3.2 \pm 0.30}{(.126 \pm .012)}$ | $\frac{2.50 \pm 0.25}{(.098 \pm .010)}$ | $\frac{1.80}{(.071)}$ |
| ZV 115 K 1812 301 | $\frac{4.7 \pm 0.40}{(.185 \pm .016)}$ | $\frac{3.2 \pm 0.30}{(.126 \pm .012)}$  | $\frac{1.90}{(.075)}$ |
| ZV 115 K 2220 501 | $\frac{5.7 \pm 0.50}{(.224 \pm .020)}$ | $\frac{5.00 \pm 0.40}{(.197 \pm .016)}$ | $\frac{1.90}{(.075)}$ |
| ZV 130 K 1210 201 | $\frac{3.2 \pm 0.30}{(.126 \pm .012)}$ | $\frac{2.50 \pm 0.25}{(.098 \pm .010)}$ | $\frac{1.80}{(.071)}$ |
| ZV 130 K 1812 301 | $\frac{4.7 \pm 0.40}{(.185 \pm .016)}$ | $\frac{3.2 \pm 0.30}{(.126 \pm .012)}$  | $\frac{1.90}{(.075)}$ |
| ZV 130 K 2220 501 | $\frac{5.7 \pm 0.50}{(.224 \pm .020)}$ | $\frac{5.00 \pm 0.40}{(.197 \pm .016)}$ | $\frac{1.90}{(.075)}$ |

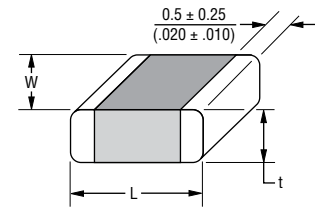

DIMENSIONS:  $\frac{\text{MM}}{\text{(INCHES)}}$

Specifications are subject to change without notice.

Users should verify actual device performance in their specific applications.

The products described herein and this document are subject to specific legal disclaimers as set forth on the last page of this document, and at [www.bourns.com/docs/legal/disclaimer.pdf](http://www.bourns.com/docs/legal/disclaimer.pdf).

# ZV SMD Series – Low Voltage Varistors



## Protection Level

Model Size 0603 - (ZV 2 M 0603 300 ~ ZV 30 K 0603 300)

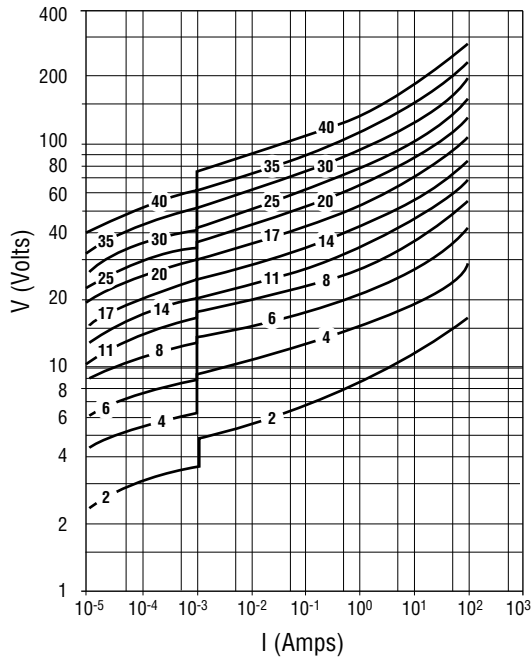

Model Size 0805 - (ZV 2 M 0805 xxx ~ ZV 30 K 0805 xxx)

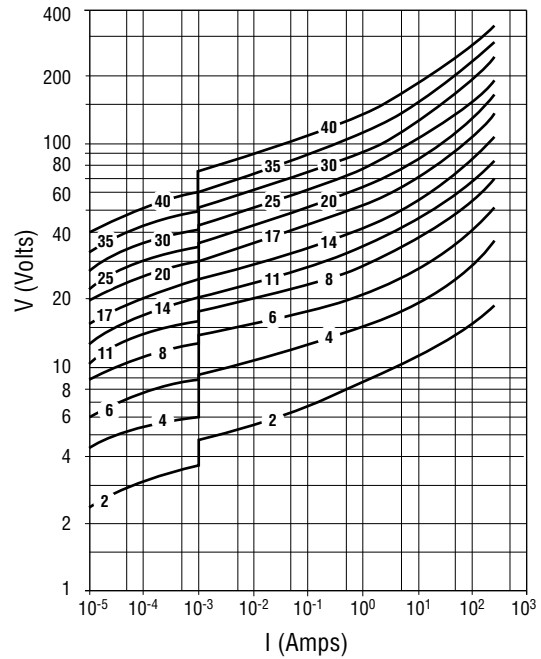

Model Size 1206 - (ZV 2 M 1206 xxx ~ ZV 60 K 1206 xxx)

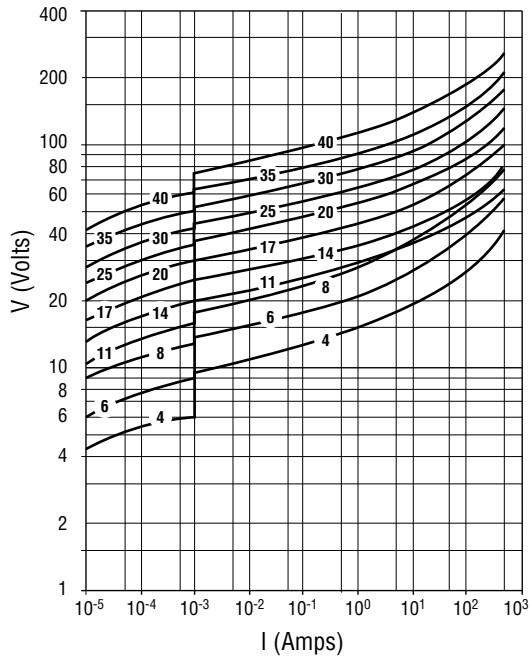

Model Size 1210 - (ZV 4 M 1210 xxx ~ ZV 95 K 1210 xxx)

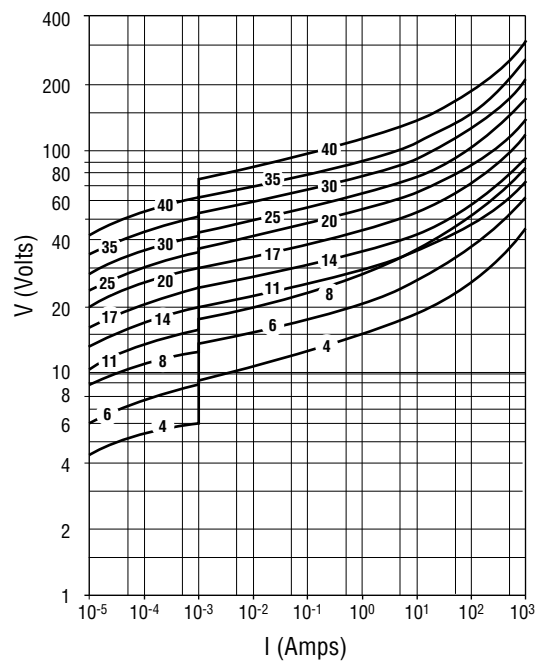

Specifications are subject to change without notice.

Users should verify actual device performance in their specific applications.

The products described herein and this document are subject to specific legal disclaimers as set forth on the last page of this document, and at [www.bourns.com/docs/legal/disclaimer.pdf](http://www.bourns.com/docs/legal/disclaimer.pdf).

# ZV SMD Series – Low Voltage Varistors



## Protection Level (Continued)

Model Size 1812 - (ZV 4 M 1812 xxx ~ ZV 95 K 1812 xxx)

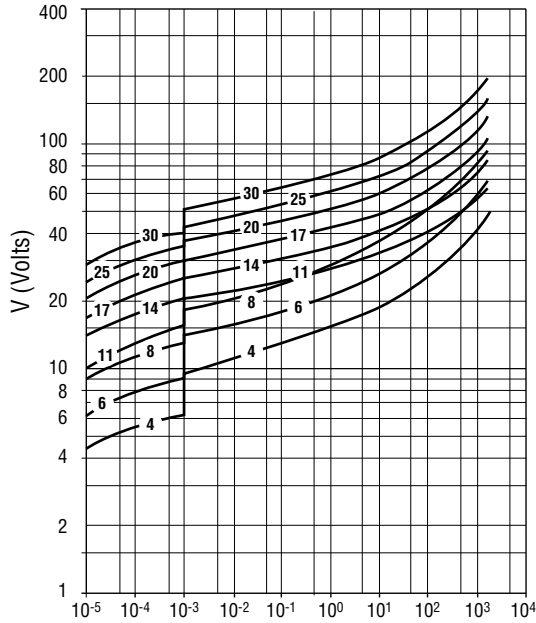

Model Size 2220 - (ZV 4 M 2220 xxx ~ ZV 95 K 1210 xxx)

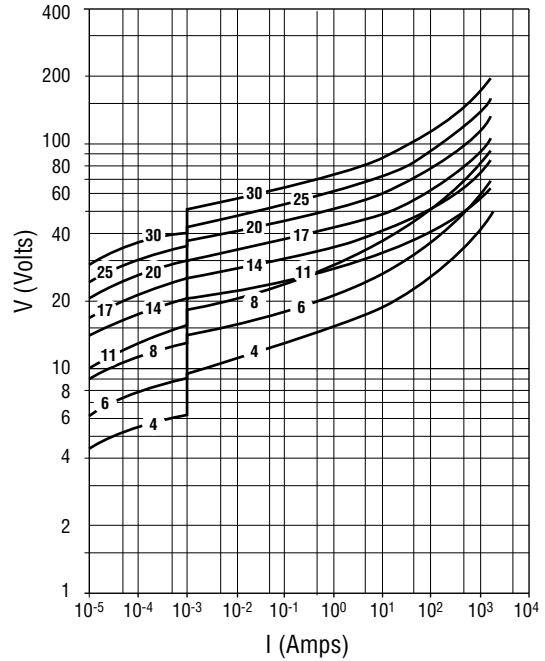

Model Size 2220 - (ZV 6 M 2220 xxx ~ ZV 30 K 2220 xxx)

## Pulse Rating Curves

Model Size 2220 - (ZV 6 M 2220 xxx ~ ZV 30 K 2220 xxx)

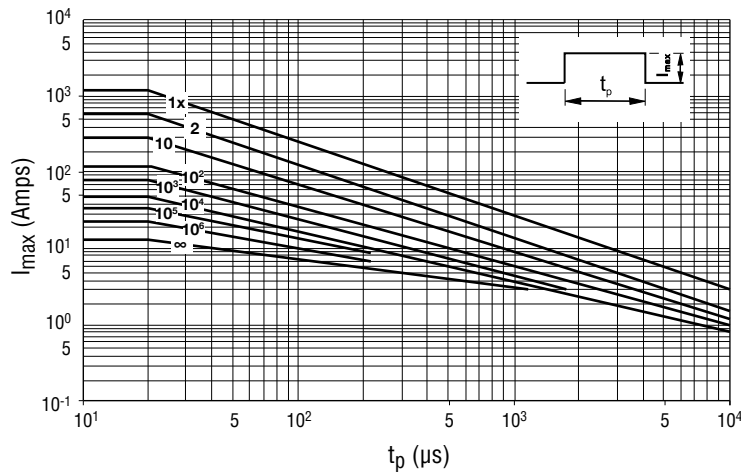

Specifications are subject to change without notice.

Users should verify actual device performance in their specific applications.

The products described herein and this document are subject to specific legal disclaimers as set forth on the last page of this document, and at [www.bourns.com/docs/legal/disclaimer.pdf](http://www.bourns.com/docs/legal/disclaimer.pdf).

## Pulse Rating Curves (Continued)

Model Size 0603 - (ZV 2 M 0603 300 ~ ZV 30 K 0603 300)

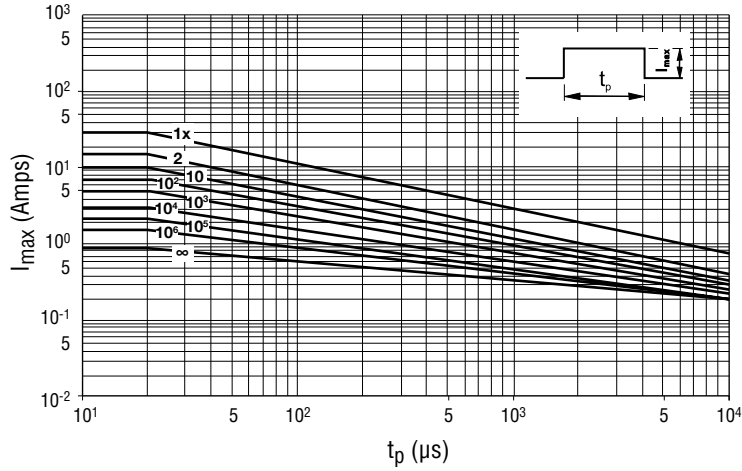

Model Size 0805 - (ZV 2 M 0805 101 ~ ZV 6 M 0805 101)

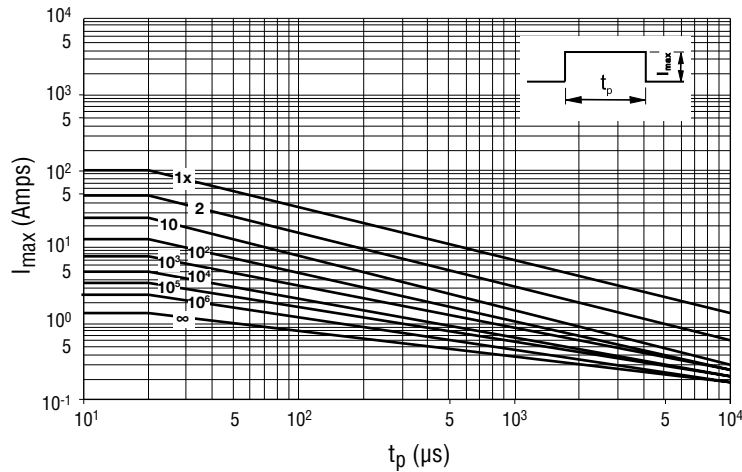

Model Size 0805 - (ZV 8 L 0805 121 ~ ZV 30 K 0805 121)

Model Size 1206 - (ZV 35 K 1206 121 ~ ZV 60 K 1206 121)

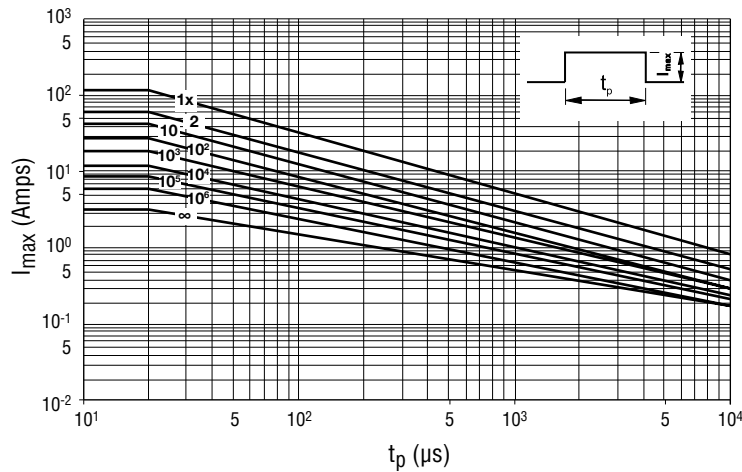

Specifications are subject to change without notice.

Users should verify actual device performance in their specific applications.

The products described herein and this document are subject to specific legal disclaimers as set forth on the last page of this document, and at [www.bourns.com/docs/legal/disclaimer.pdf](http://www.bourns.com/docs/legal/disclaimer.pdf).

## Pulse Rating Curves (Continued)

Model Size 1206 - (ZV 2 M 1206 151 ~ ZV 6 M 1206 151)

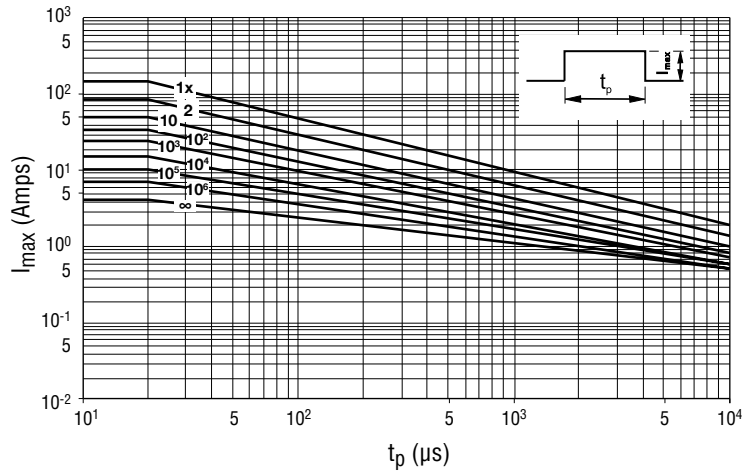

Model Size 1206 - (ZV 8 L 1206 201 ~ ZV 30 K 1206 201)

Model Size 1210 - (ZV 95 K 1210 201)

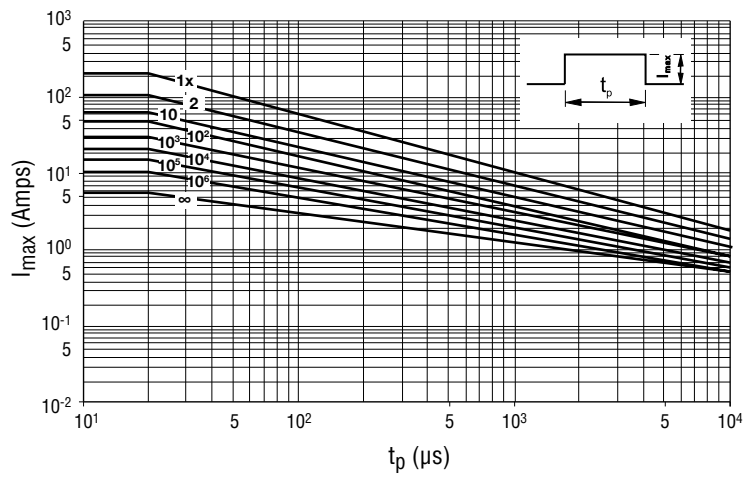

Model Size 1210 - (ZV 4 M 1210 251)

Model Size 1210 - (ZV 35 K 1210 251 ~ ZV 60 K 1210 251)

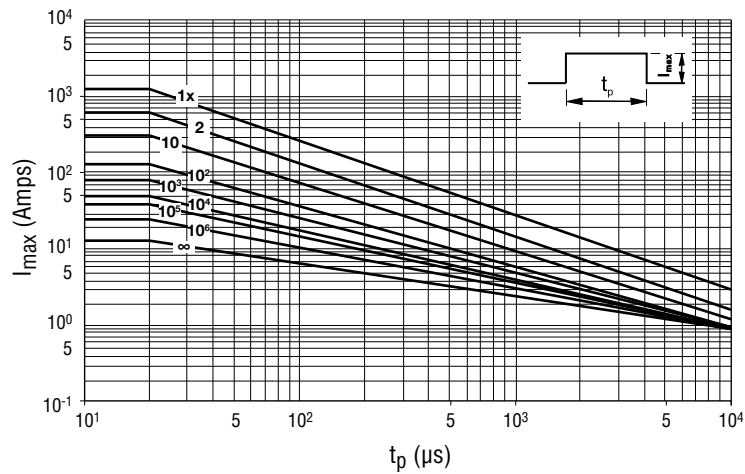

Specifications are subject to change without notice.

Users should verify actual device performance in their specific applications.

The products described herein and this document are subject to specific legal disclaimers as set forth on the last page of this document, and at [www.bourns.com/docs/legal/disclaimer.pdf](http://www.bourns.com/docs/legal/disclaimer.pdf).

# ZV SMD Series – Low Voltage Varistors



## Pulse Rating Curves (Continued)

Model Size 1210 - (ZV 6 M 1210 301)

Model Size 1210 - (ZV 30 K 1210 301)

Model Size 1812 - (ZV 95 K 1812 301)

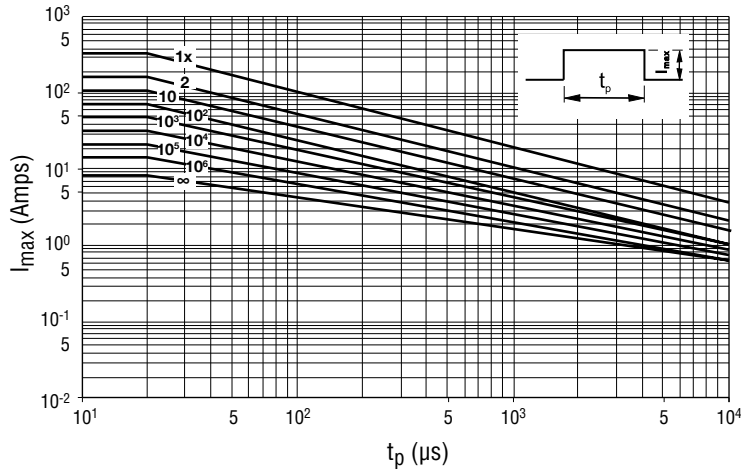

Model Size 1210 - (ZV 8 L 1210 401 ~ ZV 25 K 1210 401)

Model Size 1812 - (ZV 50 K 1812 401 ~ ZV 60 K 1812 401)

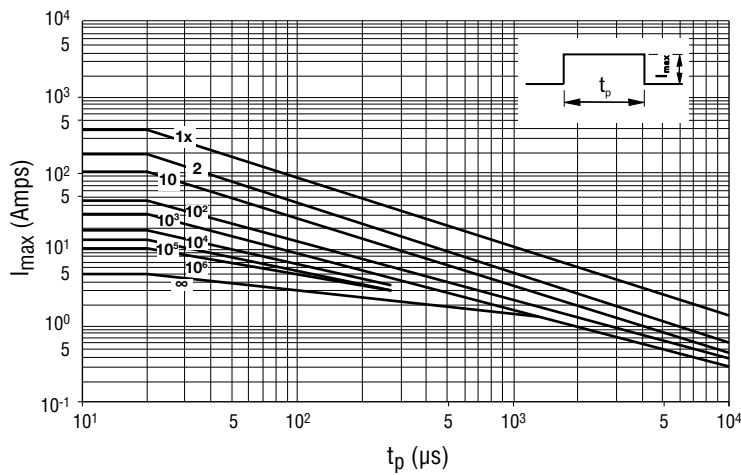

Specifications are subject to change without notice.

Users should verify actual device performance in their specific applications.

The products described herein and this document are subject to specific legal disclaimers as set forth on the last page of this document, and at [www.bourns.com/docs/legal/disclaimer.pdf](http://www.bourns.com/docs/legal/disclaimer.pdf).

# ZV SMD Series – Low Voltage Varistors

**BOURNS®**

## Pulse Rating Curves (Continued)

Model Size 1812 - (ZV 4 M 1812 501 ~ ZV 8 L 1812 501)

Model Size 2220 - (ZV 95 K 2220 501)

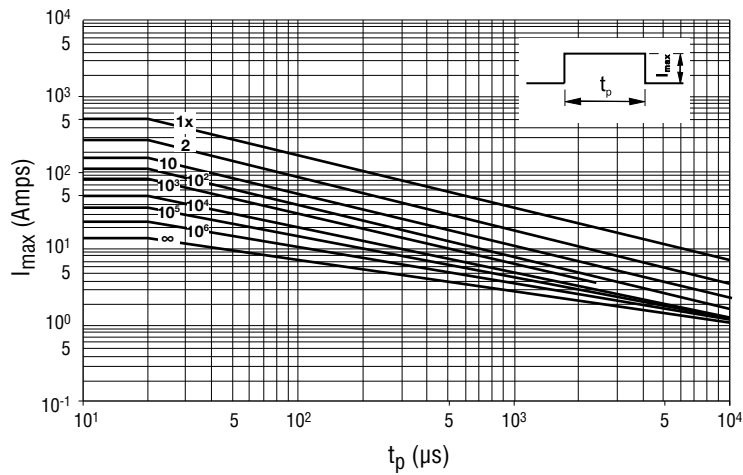

Model Size 1812 - (ZV 35 K 1812 601 ~ ZV 40 K 1812 601)

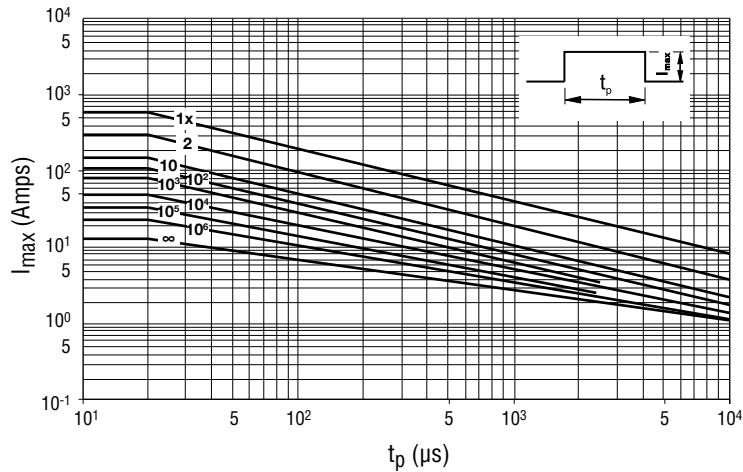

Specifications are subject to change without notice.

Users should verify actual device performance in their specific applications.

The products described herein and this document are subject to specific legal disclaimers as set forth on the last page of this document, and at [www.bourns.com/docs/legal/disclaimer.pdf](http://www.bourns.com/docs/legal/disclaimer.pdf).

# ZV SMD Series – Low Voltage Varistors

**BOURNS®**

## Pulse Rating Curves (Continued)

Model Size 1812 - (ZV 11 K 1812 801 ~ ZV 30 K 1812 801)

Model Size 2220 - (ZV 50 K 2220 801 ~ ZV 60 K 2220 801)

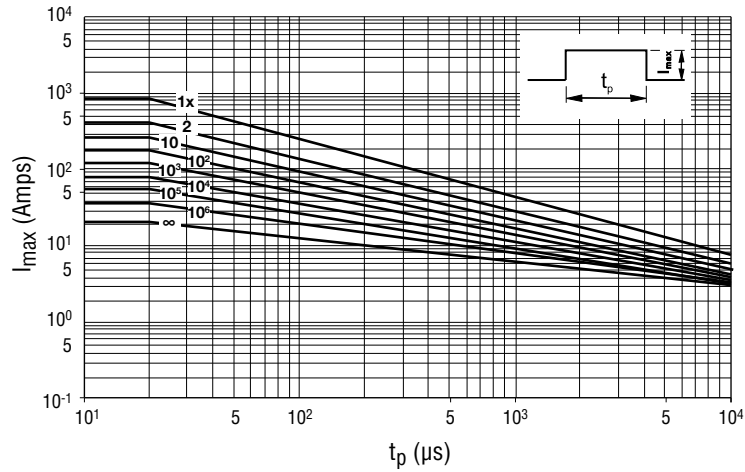

Model Size 2220 - (ZV 4 M 2220 102)

Model Size 2220 - (ZV 35 K 2220 102 ~ ZV 40 K 2220 102)

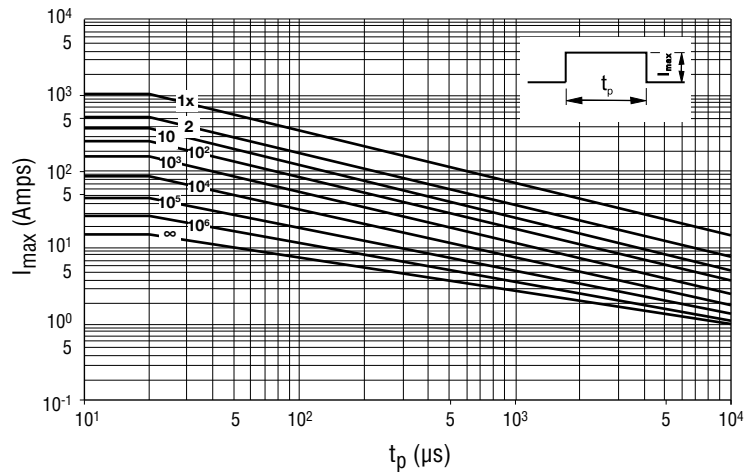

Specifications are subject to change without notice.

Users should verify actual device performance in their specific applications.

The products described herein and this document are subject to specific legal disclaimers as set forth on the last page of this document, and at [www.bourns.com/docs/legal/disclaimer.pdf](http://www.bourns.com/docs/legal/disclaimer.pdf).

# ZV SMD Series – Low Voltage Varistors



## Soldering Pad Configuration

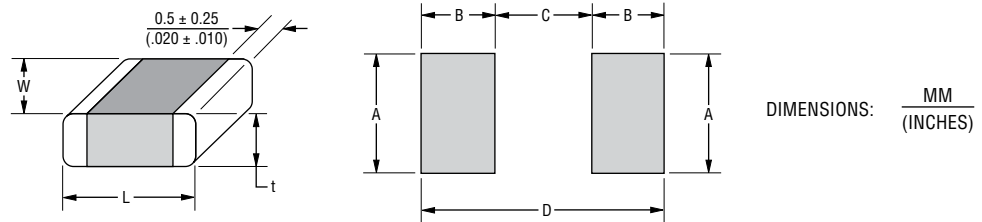

| Size | Dimension                              |                                         |                      |                      |                      |                      |                      |
|------|----------------------------------------|-----------------------------------------|----------------------|----------------------|----------------------|----------------------|----------------------|
|      | L                                      | W                                       | t (Max.)             | A                    | B                    | C                    | D                    |
| 0603 | $\frac{1.6 \pm 0.20}{(.063 \pm .008)}$ | $\frac{0.80 \pm 0.10}{(.031 \pm .004)}$ | $\frac{1.0}{(.039)}$ | $\frac{1.0}{(.039)}$ | $\frac{1.0}{(.039)}$ | $\frac{0.6}{(.024)}$ | $\frac{2.6}{(.102)}$ |
| 0805 | $\frac{2.0 \pm 0.25}{(.079 \pm .010)}$ | $\frac{1.25 \pm 0.20}{(.049 \pm .008)}$ | $\frac{1.1}{(.043)}$ | $\frac{1.4}{(.055)}$ | $\frac{1.2}{(.047)}$ | $\frac{1.0}{(.039)}$ | $\frac{3.4}{(.134)}$ |
| 1206 | $\frac{3.2 \pm 0.30}{(.126 \pm .012)}$ | $\frac{1.60 \pm 0.20}{(.063 \pm .008)}$ | $\frac{1.6}{(.063)}$ | $\frac{1.8}{(.071)}$ | $\frac{1.2}{(.047)}$ | $\frac{2.1}{(.083)}$ | $\frac{4.5}{(.177)}$ |
| 1210 | $\frac{3.2 \pm 0.30}{(.126 \pm .012)}$ | $\frac{2.50 \pm 0.25}{(.098 \pm .010)}$ | $\frac{1.8}{(.071)}$ | $\frac{2.8}{(.110)}$ | $\frac{1.2}{(.047)}$ | $\frac{2.1}{(.083)}$ | $\frac{4.5}{(.177)}$ |
| 1812 | $\frac{4.7 \pm 0.40}{(.185 \pm .016)}$ | $\frac{3.2 \pm 0.30}{(.126 \pm .012)}$  | $\frac{1.9}{(.075)}$ | $\frac{3.6}{(.141)}$ | $\frac{1.5}{(.060)}$ | $\frac{3.2}{(.126)}$ | $\frac{6.2}{(.244)}$ |
| 2220 | $\frac{5.7 \pm 0.50}{(.224 \pm .020)}$ | $\frac{5.00 \pm 0.40}{(.197 \pm .016)}$ | $\frac{1.9}{(.075)}$ | $\frac{5.5}{(.217)}$ | $\frac{1.5}{(.060)}$ | $\frac{4.2}{(.165)}$ | $\frac{7.2}{(.283)}$ |

## Packaging Specifications

Conforms to IEC Publication 286-3 Ed. 4: 2007-06

### Tape

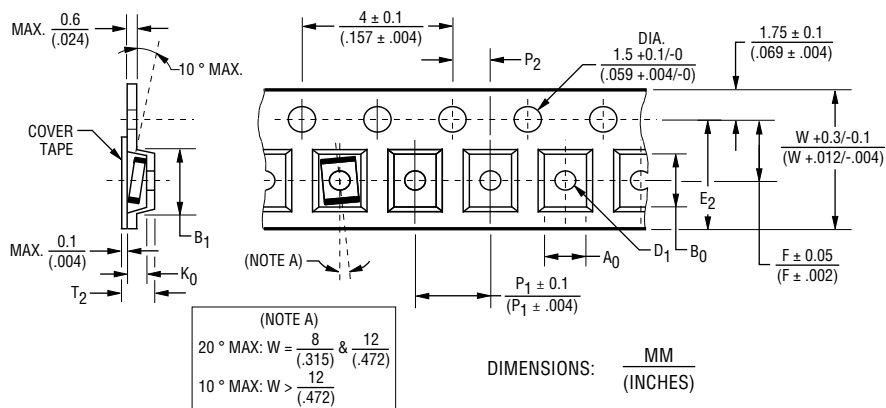

Specifications are subject to change without notice.

Users should verify actual device performance in their specific applications.

The products described herein and this document are subject to specific legal disclaimers as set forth on the last page of this document, and at [www.bourns.com/docs/legal/disclaimer.pdf](http://www.bourns.com/docs/legal/disclaimer.pdf).

# ZV SMD Series – Low Voltage Varistors



## Packaging Specifications (Continued)

Conforms to IEC Publication 286-3 Ed. 4: 2007-06

### Reel

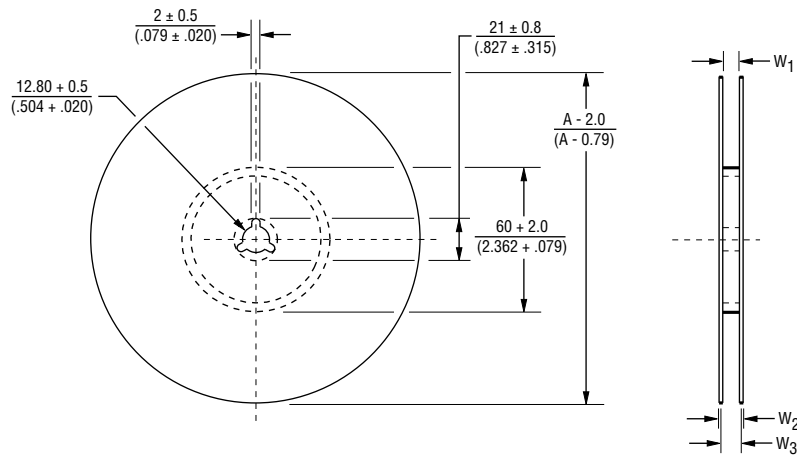

| Dimension                | Model Size            |                      |                       |                        |                       |                       |
|--------------------------|-----------------------|----------------------|-----------------------|------------------------|-----------------------|-----------------------|
|                          | 0603                  | 0805                 | 1206                  | 1210                   | 1812                  | 2220                  |
| A <sub>0</sub>           | $\frac{1.2}{(.047)}$  | $\frac{1.6}{(.063)}$ | $\frac{1.9}{(.075)}$  | $\frac{2.9}{(.114)}$   | $\frac{3.75}{(.148)}$ | $\frac{5.6}{(.220)}$  |
| B <sub>0</sub>           | $\frac{1.9}{(.075)}$  | $\frac{2.4}{(.094)}$ | $\frac{3.75}{(.148)}$ | $\frac{3.7}{(.146)}$   | $\frac{5}{(.197)}$    | $\frac{6.25}{(.246)}$ |
| K <sub>0</sub> MAX.      | $\frac{1.1}{(.043)}$  |                      | $\frac{1.8}{(.071)}$  | $\frac{2.0}{(.079)}$   |                       |                       |
| B <sub>1</sub> MAX.      | $\frac{4.35}{(.171)}$ |                      |                       | $\frac{8.2}{(.323)}$   |                       |                       |
| D <sub>1</sub> DIA. MIN. | $\frac{0.3}{(.012)}$  |                      |                       | $\frac{1.5}{(.059)}$   |                       |                       |
| E <sub>2</sub> MIN.      | $\frac{6.25}{(.246)}$ |                      |                       | $\frac{10.25}{(.403)}$ |                       |                       |
| P <sub>1</sub>           | $\frac{4}{(.157)}$    |                      |                       | $\frac{8}{(.315)}$     |                       |                       |

| Dimension           | Model Size                                    |      |                                                |                                    |      |      |
|---------------------|-----------------------------------------------|------|------------------------------------------------|------------------------------------|------|------|
|                     | 0603                                          | 0805 | 1206                                           | 1210                               | 1812 | 2220 |
| F                   | $\frac{3.5}{(.138)}$                          |      |                                                | $\frac{5.5}{(.217)}$               |      |      |
| W                   | $\frac{8.0}{(.315)}$                          |      |                                                | $\frac{12.0}{(.472)}$              |      |      |
| T <sub>2</sub> MAX. | $\frac{3.5}{(.138)}$                          |      |                                                | $\frac{6.5}{(.256)}$               |      |      |
| W <sub>1</sub>      | $\frac{8.4 + 1.5}{(.331 + .059)}$             |      |                                                | $\frac{12.4 + 2.0}{(.488 + .079)}$ |      |      |
| W <sub>2</sub> MAX. | $\frac{14.4}{(.567)}$                         |      |                                                | $\frac{18.4}{(.724)}$              |      |      |
| W <sub>3</sub>      | $\frac{7.9}{(.311)}$ to $\frac{10.9}{(.429)}$ |      | $\frac{11.9}{(.469)}$ to $\frac{15.4}{(.606)}$ |                                    |      |      |
| A DIA.              | $\frac{180}{(7.087)}$                         |      |                                                |                                    |      |      |

DIMENSIONS:  $\frac{\text{MM}}{\text{(INCHES)}}$

## Packaging Quantities

| Series | Voltage Range (V) | 0603 | 0805 | 1206 | 1210 | 1812 | 2220 |
|--------|-------------------|------|------|------|------|------|------|
| ZV     | 2 to 14           | 3500 | 4000 | 4000 | 4000 | 1500 | 1000 |
|        | 17                | 3500 | 3500 | 2500 | 2500 | 1500 | 1000 |
|        | 20 to 40          | 3500 | 3500 | 2500 | 2500 | 1000 | 1000 |
|        | 50 to 130         | -    | -    | 2000 | 2000 | 1000 | 1000 |

REEL SIZE: 180 MM

Specifications are subject to change without notice.

Users should verify actual device performance in their specific applications.

The products described herein and this document are subject to specific legal disclaimers as set forth on the last page of this document, and at [www.bourns.com/docs/legal/disclaimer.pdf](http://www.bourns.com/docs/legal/disclaimer.pdf).

## Soldering Recommendations for SMD Components

Popular soldering techniques used for surface mounted components are Wave and Infrared Reflow processes. Both processes can be performed with Pb-containing or Pb-free solders. The termination options available for these soldering techniques are AgPd and NiSn End Terminations.

| End Termination      | Designation     | Recommended and Suitable for        | RoHS Compliant |
|----------------------|-----------------|-------------------------------------|----------------|
| Ag/Pd                | ZV Series       | Pb-containing soldering             | Yes            |
| NiSn End Termination | ZV Series ...Ni | Pb-containing and Pb-free soldering | Yes            |

### Wave Soldering

This process is generally associated with discrete components mounted on the underside of printed circuit boards, or for large top-side components with bottom-side mounting tabs to be attached, such as the frames of transformers, relays, connectors, etc. SMD varistors to be wave soldered are first glued to the circuit board, usually with an epoxy adhesive. When all components on the PCB have been positioned and an appropriate amount of time is allowed for adhesive curing, the completed assembly is then placed on a conveyor and run through a single, double wave process.

### Infrared Reflow Soldering

These reflow processes are typically associated with top-side component placement. This technique utilizes a mixture of adhesive and solder compounds (and sometimes fluxes) that are blended into a paste. The paste is then screened onto PCB soldering pads specifically designed to accept a particular sized SMD component. The recommended solder paste wet layer thickness is 100 to 300  $\mu\text{m}$ . Once the circuit board is fully populated with SMD components, it is placed in a reflow environment, where the paste is heated to slightly above its eutectic temperature. When the solder paste reflows, the SMD components are attached to the solder pads.

### Solder Fluxes

Solder fluxes are generally applied to populated circuit boards to keep oxides from forming during the heating process and to facilitate the flowing of the solder. Solder fluxes can be either a part of the solder paste compound or separate materials, usually fluids.

Recommended fluxes are:

- non-activated (R) fluxes, whenever possible
- mildly activated (RMA) fluxes of class L3CN
- class ORLO

Activated (RA), water soluble or strong acidic fluxes with a chlorine content > 0.2 wt. % are NOT RECOMMENDED. The use of such fluxes could create high leakage current paths along the body of the varistor components.

When a flux is applied prior to wave soldering, it is important to completely dry any residual flux solvents prior to the soldering process.

### Thermal Shock

To avoid the possibility of generating stresses in the varistor chip due to thermal shock, a preheat stage to within 100 °C of the peak soldering process temperature is recommended. Additionally, SMD varistors should not be subjected to a temperature gradient greater than 4 °C/sec., with an ideal gradient being 2 °C/sec. Peak temperatures should be controlled. Wave and Reflow soldering conditions for SMD varistors with Pb-containing solders are shown on the next page in Fig. 1 and 2 respectively, while Wave and Reflow soldering conditions for SMD varistors with Pb-free solders are shown in Fig. 1 and 3.

Whenever several different types of SMD components are being soldered, each having a specific soldering profile, the soldering profile with the least heat and the minimum amount of heating time is recommended. Once soldering has been completed, it is necessary to minimize the possibility of thermal shock by allowing the hot PCB to cool to less than 50 °C before cleaning.

## Soldering Recommendations for SMD Components (Continued)

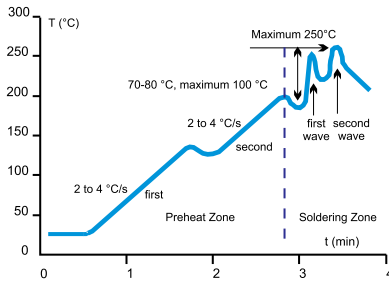

Fig. 1. Wave Soldering Temperature Profile for Pb-free and Pb-containing Soldering

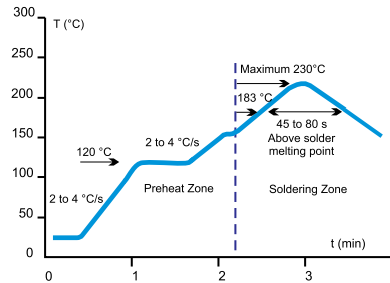

Fig. 2. Infrared Reflow Temperature Profile for Pb-containing Soldering

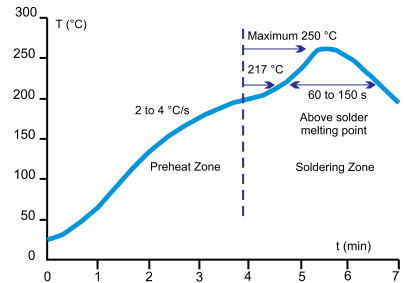

Fig. 3. Reflow Temperature Profile for Pb-free Soldering

### Inspection Criteria

When Wave or Infrared Reflow processes are used, the inspection criteria to determine acceptable solder joints will depend on several key variables, principally termination material process profiles.

### Pb-containing Wave and IR Reflow Soldering

Typical “before” and “after” soldering results for Silver/Palladium (AgPd) and NiSn End Terminations can be seen in Fig. 4. Both NiSn type and silver/palladium terminated varistors form a reliable electrical contact and metallurgical bond between the end terminations and the solder pads. The bond between these two metallic surfaces is exceptionally strong and has been tested by both vertical pull and lateral (horizontal) push tests. The results meet or exceed established industry standards for adhesion.

The solder joint appearance of a barrier type terminated versus a silver/palladium terminated varistor will be slightly different. Solder forms a metallurgical junction with the thin tin-alloy (over the barrier layer), and due to its small volume “climbs” the outer surface of the terminations, so the meniscus will be slightly lower. This optical appearance difference should be taken into consideration when programming visual inspection of the PCB after soldering.

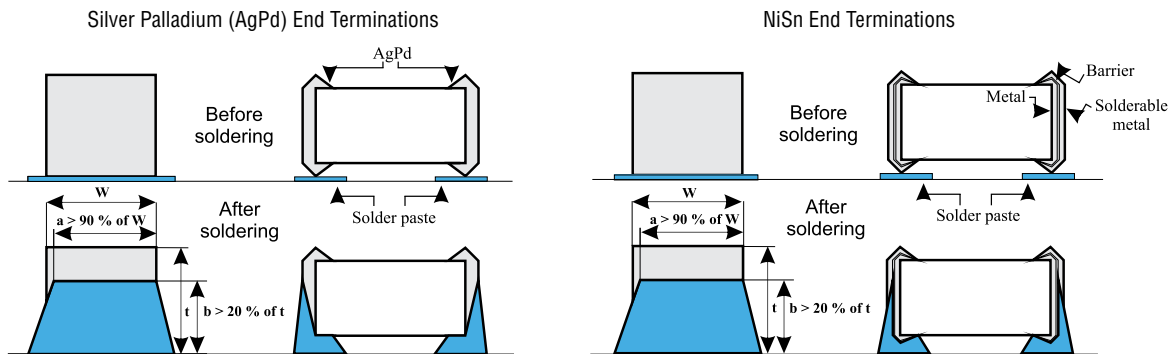

Fig. 4 Soldering Criterion in case of Wave and IR Reflow Pb-containing Soldering

## Soldering Recommendations for SMD Components (Continued)

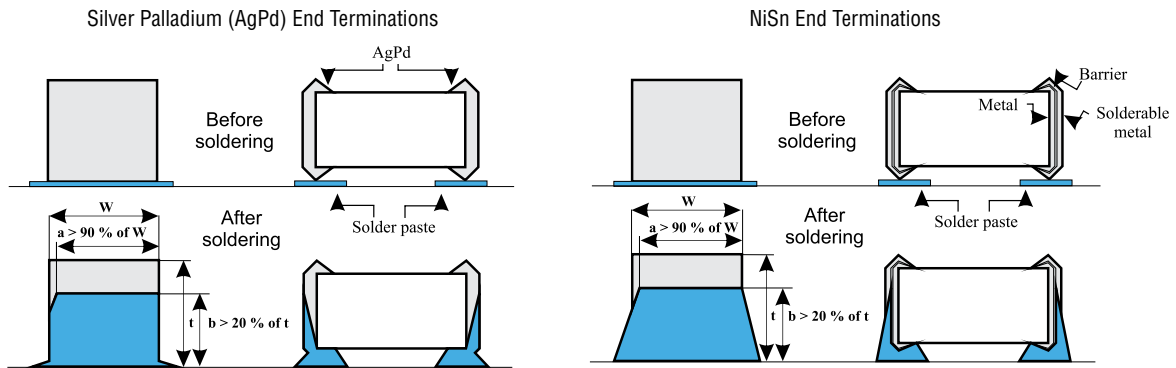

Fig. 5 Soldering Criterion in case of Wave and IR Reflow Pb-free Soldering

### Pb-free Wave and IR Reflow Soldering

Solder forms a metallurgical junction with the entire volume of the end termination, i.e., it diffuses from pad to end termination across the inner side, forming a “mirror” or “negative meniscus. The height of the solder penetration can be clearly seen on the end termination and is always 30 % higher than the chip height.

Since NiSn end terminations on Bourns® chips do not require the use of sometimes problematic nickel and tin-alloy electroplating processes, these varistors are truly considered environmentally friendly.

### Solder Test and Retained Samples

Reflow soldering test based on J-STD-020D.1 and soldering test by dipping based on IEC 60068- 2 for Pb-free solders are performed on each production lot as shown in the following chart. Test results and accompanying samples are retained for a minimum of two (2) years. The solderability of a specific lot can be checked at any time within this period, should a customer require this information.

| Test                               | Resistance to Flux                          | Solderability                                       | Static Leaching (Simulation of Reflow Soldering)               | Dynamic Leaching (Simulation of Wave Soldering)                |
|------------------------------------|---------------------------------------------|-----------------------------------------------------|----------------------------------------------------------------|----------------------------------------------------------------|
| Soldering method                   | Dipping                                     | Dipping                                             | Dipping                                                        | Dipping with Agitation                                         |
| Flux                               | L3CN, ORL0                                  | L3CN, ORL0, R                                       | L3CN, ORL0, R                                                  | L3CN, ORL0, R                                                  |
| Pb Solder                          | 62Sn / 36Pb / 2Ag                           |                                                     |                                                                |                                                                |
| Pb Soldering Temperature (°C)      | 235 ± 5                                     | 235 ± 5                                             | 260 ± 5                                                        | 235 ± 5                                                        |
| Pb-Free Solder                     | Sn96 / Cu0,4-0,8 / 3-4Ag                    |                                                     |                                                                |                                                                |
| Pb-Free Soldering Temperature (°C) | 250 ± 5                                     | 250 ± 5                                             | 280 ± 5                                                        | 250 ± 5                                                        |
| Soldering Time (sec.)              | 2                                           | 210                                                 | 10                                                             | > 15                                                           |
| Burn-in Conditions                 | $V_{dcmax}$ , 48 hours                      | -                                                   | -                                                              | -                                                              |
| Acceptance Criterion               | $dV_n < 5\%$ , $i_{dc}$ must stay unchanged | > 95 % of end termination must be covered by solder | > 95 % of end termination must be intact and covered by solder | > 95 % of end termination must be intact and covered by solder |

## Soldering Recommendations for SMD Components (Continued)

### Rework Criteria - Soldering Iron

Unless absolutely necessary, the use of soldering irons is NOT recommended for reworking varistor chips. If no other means of rework is available, the following criteria must be strictly followed:

- Do not allow the tip of the iron to directly contact the top of the chip
- Do not exceed the following soldering iron specifications:
  - Output Power.....30 Watts Maximum
  - Temperature of Soldering Iron Tip.....280 °C Maximum
  - Soldering Time..... 10 Seconds Maximum

### Storage Conditions

SMD varistors should be used within 1 year of purchase to avoid possible soldering problems caused by oxidized terminals. The storage environment should be controlled, with humidity less than 40 % and temperature between -25 and +45 °C. Varistor chips should always be stored in their original packaged unit.

When varistor chips have been in storage for more than 1 year, and when there is evidence of solderability difficulties, Bourns can often “refresh” the terminations to eliminate these problems.

## Reliability - Lifetime

### Pb-free Wave and IR Reflow Soldering

In general, **reliability** is the ability of a component to perform and maintain its functions in routine circumstances, as well as in hostile or unexpected circumstances.

The Mean life of the ZV series is a function of:

- Factor of Applied Voltage
- Ambient Temperature

Mean life is closely related to Failure rate (formula).

Mean life (ML) is the arithmetic mean (average) time to failure of a component.

**Failure rate** is the frequency with which an engineered system or component fails, expressed, for example, in failures per hour. Failure rate is usually time dependent, and an intuitive corollary is that the rate changes over time versus the expected life cycle of a system.

### Failure rate formula - calculation

$$\Lambda = \frac{10^9}{ML [h]} \text{ [fit]}$$

### FAV - Factor of Applied Voltage

$$FAV = \frac{V_{apl}}{V_{max}}$$

$V_{apl}$  .....applied voltage

$V_{max}$  .....maximum operating voltage

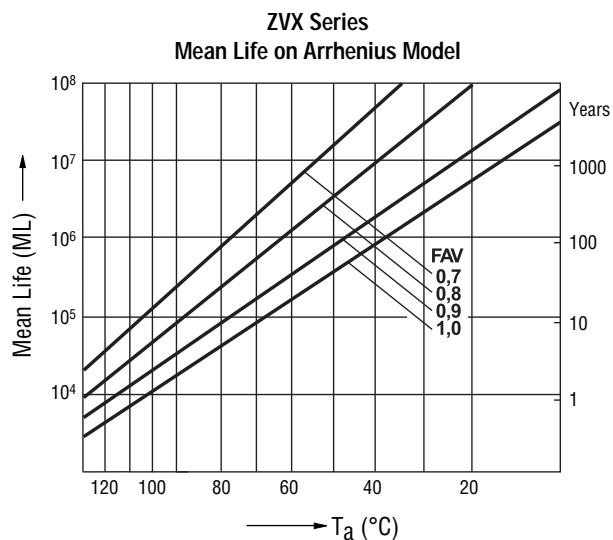

Specifications are subject to change without notice.

Users should verify actual device performance in their specific applications.

The products described herein and this document are subject to specific legal disclaimers as set forth on the last page of this document, and at [www.bourns.com/docs/legal/disclaimer.pdf](http://www.bourns.com/docs/legal/disclaimer.pdf).

## ZV SMD Series – Low Voltage Varistors

**BOURNS®**

### Reliability Testing Procedures

Varistor test procedures comply with CECC 42200, IEC 1051-1/2 (and AEC-Q200, where applicable). Test results are available upon customer request. Special tests can be performed upon customer request.

| Reliability Parameter                        | Test                                 | Tested According to                                                                                                                                                                                                                                                                                                         | Condition to be Satisfied after Testing                    |
|----------------------------------------------|--------------------------------------|-----------------------------------------------------------------------------------------------------------------------------------------------------------------------------------------------------------------------------------------------------------------------------------------------------------------------------|------------------------------------------------------------|
| <b>AC/DC Bias Reliability</b>                | AC/DC Life Test                      | CECC 42200, Test 4.20 or<br>IEC 1051-1, Test 4.20,<br>AEC-Q200 Test 8 - 1000 h at UCT                                                                                                                                                                                                                                       | $ \delta V_N (1 \text{ mA})  < 10 \%$                      |
| <b>Pulse Current Capability</b>              | $I_{\text{max}} 8/20 \mu\text{s}$    | CECC 42200, Test C 2.1 or<br>IEC 1051-1, Test 4.5<br>10 pulses in the same direction at<br>2 pulses per minute at maximum peak current for 10 pulses                                                                                                                                                                        | $ \delta V_N (1 \text{ mA})  < 10 \%$<br>no visible damage |
| <b>Pulse Energy Capability</b>               | $W_{\text{max}} 10/1000 \mu\text{s}$ | CECC 42200, Test C 2.1 or<br>IEC 1051-1, Test 4.5<br>10 pulses in the same direction at<br>1 pulse every 2 minutes at maximum peak current for 10 pulses                                                                                                                                                                    | $ \delta V_N (1 \text{ mA})  < 10 \%$<br>no visible damage |
| <b>WLD Capability</b>                        | WLD x 10                             | ISO 7637, Test pulse 5, 10 pulses at rate of 1 per minute                                                                                                                                                                                                                                                                   | $ \delta V_N (1 \text{ mA})  < 15 \%$<br>no visible damage |
| <b>V<sub>jump</sub> Capability</b>           | V <sub>jump</sub> 5 min.             | Increase of supply voltage to $V \geq V_{\text{jump}}$ for 1 minute                                                                                                                                                                                                                                                         | $ \delta V_N (1 \text{ mA})  < 15 \%$<br>no visible damage |
| <b>Environmental and Storage Reliability</b> | Climatic Sequence                    | CECC 42200, Test 4.16 or<br>IEC 1051-1, Test 4.17<br>a) Dry heat, 16h, UCT, Test Ba, IEC 68-2-2<br>b) Damp heat, cyclic, the first cycle: 55 °C, 93 % RH, 24 h,<br>Test Db 68-2-4<br>c) Cold, LCT, 2 h, Test Aa, IEC 68-2-1<br>d) Damp heat cyclic, remaining 5 cycles: 55 °C, 93 % RH,<br>24 h/cycle, Test Bd, IEC 68-2-30 | $ \delta V_N (1 \text{ mA})  < 10 \%$                      |
|                                              | Thermal Shock                        | CECC 42200, Test 4.12, Test Na, IEC 68-2-14,<br>AEC-Q200 Test 16, 5                                                                                                                                                                                                                                                         | $ \delta V_N (1 \text{ mA})  < 10 \%$<br>no visible damage |
|                                              | Steady State Damp Heat               | CECC 42200, Test 4.17, Test Ca, IEC 68-2-3,<br>AEC-Q200 Test 6, 56 days, 40 °C, 93 % RH,<br>AEC-Q200 Test 7: Bias, Rh, T all at 85.                                                                                                                                                                                         | $ \delta V_N (1 \text{ mA})  < 10 \%$                      |
|                                              | Storage Test                         | IEC 68-2-2, Test Ba, AEC-Q200 Test 3, 1000 h at maximum storage temperature                                                                                                                                                                                                                                                 | $ \delta V_N (1 \text{ mA})  < 5 \%$                       |

*Continued on Next Page*

Specifications are subject to change without notice.

Users should verify actual device performance in their specific applications.

The products described herein and this document are subject to specific legal disclaimers as set forth on the last page of this document, and at [www.bourns.com/docs/legal/disclaimer.pdf](http://www.bourns.com/docs/legal/disclaimer.pdf).

# ZV SMD Series – Low Voltage Varistors



## Reliability Testing Procedures (Continued)

| Reliability Parameter                  | Test                         | Tested According to                                                                                                                                                                                                                                                                            | Condition to be Satisfied after Testing                                                                           |
|----------------------------------------|------------------------------|------------------------------------------------------------------------------------------------------------------------------------------------------------------------------------------------------------------------------------------------------------------------------------------------|-------------------------------------------------------------------------------------------------------------------|
| <b>Mechanical Reliability</b>          | Solderability                | CECC 42200, Test 4.10.1, Test Ta, IEC 68-2-20 solder bath and reflow method                                                                                                                                                                                                                    | Solderable at shipment and after 2 years of storage, criteria: >95% must be covered by solder for reflow meniscus |
|                                        | Resistance to Soldering Heat | CECC 42200, Test 4.10.2, Test Tb, IEC 68-2-20 solder bath nad reflow method                                                                                                                                                                                                                    | $ \delta V_n (1 \text{ mA})  < 5 \%$                                                                              |
|                                        | Terminal Strength            | JIS-C-6429, App. 1, 18N for 60 sec. - same for AEC-Q200 Test 22                                                                                                                                                                                                                                | No visual damage                                                                                                  |
|                                        | Board Flex                   | JIS-C-6429, App. 2, 2 mm min.<br>AEC-Q200 test 21 - Board flex: 2 mm flex min.                                                                                                                                                                                                                 | $ \delta V_n (1 \text{ mA})  < 2 \%$<br>No visible damage                                                         |
|                                        | Vibration                    | CECC 42200, Test 4.15, Test Fc, IEC 68-2-6,<br>AEC-Q200 Test 14<br>Frequency range 10 to 55 Hz (AEC: 10-2000 Hz)<br>Amplitude 0.75 m/s <sup>2</sup> or 98 m/s <sup>2</sup> (AEC: 5 g for 20 minutes) Total duration 6 h (3x2 h) (AEC: 12 cycles each of 3 directions)<br>Waveshape - half sine | $ \delta V_n (1 \text{ mA})  < 2 \%$<br>No visible damage                                                         |
|                                        | Mechanical Shock             | CECC 42200, Test 4.14, Test Ea, IEC 68-2-27, AEC-Q200 Test 13.<br>Acceleration = 490 m/s <sup>2</sup> (AEC: MIL-STD-202-Method 213),<br>Pulse duration = 11 ms,<br>Waveshape - half sine; Number of shocks = 3x6                                                                               | $ \delta V_n (1 \text{ mA})  < 10 \%$<br>No visible damage                                                        |
| <b>Electrical Transient Conduction</b> | ISO-7637-1 Pulses            | AEC-Q200 Test 30: Test pulses 1 to 3.<br>Also other pulses - freestyle.                                                                                                                                                                                                                        | $ \delta V_n (1 \text{ mA})  < 10 \%$<br>No visible damage                                                        |

## How to Order

**ZV20K1210401NIR1yy**

Series Designator \_\_\_\_\_  
 ZV = ZV Series

Maximum Continuous Working Voltage ( $V_{rms}$ ) \_\_\_\_\_

$V_n$  Tolerance \_\_\_\_\_  
 K =  $\pm 10 \%$ , L =  $\pm 15 \%$ , M =  $\pm 20 \%$

Model Size \_\_\_\_\_  
 • 0603      • 1206      • 1812  
 • 0805      • 1210      • 2220

Maximum Surge Current \_\_\_\_\_  
 • 300 = 30 A    • 251 = 250 A    • 801 = 800 A  
 • 101 = 100 A   • 401 = 400 A    • 102 = 1000 A  
 • 151 = 150 A   • 501 = 500 A    • 122 = 1200 A

End Terminations \_\_\_\_\_  
 • (Blank) = AgPd end terminations suitable for Pb reflow soldering  
 • Ni = NiSn barrier type end terminations suitable for Pb and Pb-free reflow soldering (standard)

Packaging \_\_\_\_\_  
 R1 = Reel 180 mm

Special Requirements \_\_\_\_\_  
 • yy

## Instructions for Creating Orderable Part Number:

- 1) Start with base part number in characteristics table (example: ZV20K1210401).
- 2) Add End Termination: NI standard (example part number becomes ZV20K1210401NI).
- 3) Add Packaging: R1 (example part number becomes ZV20K1210401NIR1).
- 4) Part number can have no spaces or lower case letters.

## Typical Part Marking

No marking.

Specifications are subject to change without notice.

Users should verify actual device performance in their specific applications.

The products described herein and this document are subject to specific legal disclaimers as set forth on the last page of this document, and at [www.bourns.com/docs/legal/disclaimer.pdf](http://www.bourns.com/docs/legal/disclaimer.pdf).

## Terminology

| Term                               | Symbol        | Definition                                                                                                                                                                                                                                                                                                                                                                                                                                                                                                                                                           |
|------------------------------------|---------------|----------------------------------------------------------------------------------------------------------------------------------------------------------------------------------------------------------------------------------------------------------------------------------------------------------------------------------------------------------------------------------------------------------------------------------------------------------------------------------------------------------------------------------------------------------------------|
| Rated AC Voltage .....             | $V_{rms}$     | Maximum continuous sinusoidal AC voltage (<5 % total harmonic distortion) which may be applied to the component under continuous operation conditions at +25 °C                                                                                                                                                                                                                                                                                                                                                                                                      |
| Rated DC Voltage.....              | $V_{dc}$      | Maximum continuous DC voltage (<5 % ripple) which may be applied to the component under continuous operating conditions at +25 °C                                                                                                                                                                                                                                                                                                                                                                                                                                    |
| Supply Voltage.....                | $V$           | The voltage by which the system is designated and to which certain operating characteristics of the system are referred; $V_{rms} = 1.1 \times V$                                                                                                                                                                                                                                                                                                                                                                                                                    |
| Leakage Current.....               | $I_{dc}$      | The current passing through the varistor at $V_{dc}$ and at +25 °C or at any other specified temperature                                                                                                                                                                                                                                                                                                                                                                                                                                                             |
| Varistor Voltage .....             | $V_n$         | Voltage across the varistor measured at a given reference current ( $I_n$ )                                                                                                                                                                                                                                                                                                                                                                                                                                                                                          |
| Reference Current.....             | $I_n$         | Reference current = 1 mA DC                                                                                                                                                                                                                                                                                                                                                                                                                                                                                                                                          |
| Clamping Voltage .....             | $V_c$         | The peak voltage developed across the varistor under standard atmospheric conditions, when passing an 8/20 $\mu s$ class current pulse                                                                                                                                                                                                                                                                                                                                                                                                                               |
| Protection Level                   |               |                                                                                                                                                                                                                                                                                                                                                                                                                                                                                                                                                                      |
| Class Current.....                 | $I_c$         | A peak value of current which is 1/10 of the maximum peak current for 100 pulses at two per minute for the 8/20 $\mu s$ pulse                                                                                                                                                                                                                                                                                                                                                                                                                                        |
| Voltage Clamping Ratio.....        | $V_c/V_{app}$ | A figure of merit measure of the varistor clamping effectiveness as defined by the symbols $V_c/V_{app}$ , where ( $V_{app} = V_{rms}$ or $V_{dc}$ )                                                                                                                                                                                                                                                                                                                                                                                                                 |
| Jump Start Transient .....         | $V_{jump}$    | The jump start transient results from the temporary application of an overvoltage in excess of the rated battery voltage. The circuit power supply may be subjected to a temporary overvoltage condition due to the voltage regulation failing or it may be deliberately generated when it becomes necessary to boost start the car.                                                                                                                                                                                                                                 |
| Rated Single Pulse .....           | $W_{max}$     | Energy which may be dissipated for a single 10/1000 $\mu s$ pulse of a maximum rated current, with rated AC voltage or rated DC voltage also applied, without causing device failure                                                                                                                                                                                                                                                                                                                                                                                 |
| Transient Energy                   |               |                                                                                                                                                                                                                                                                                                                                                                                                                                                                                                                                                                      |
| Load Dump Transient .....          | WLD           | Load Dump is a transient which occurs in automotive environments. It is an exponentially decaying positive voltage which occurs in the event of a battery disconnect while the alternator is still generating charging current with other loads remaining on the alternator circuit at the time of battery disconnect.                                                                                                                                                                                                                                               |
| Rated Peak Single Pulse.....       | $I_{max}$     | Maximum peak current which may be applied for a single 8/20 $\mu s$ pulse, with rated line voltage also applied, without causing device failure                                                                                                                                                                                                                                                                                                                                                                                                                      |
| Transient Current                  |               |                                                                                                                                                                                                                                                                                                                                                                                                                                                                                                                                                                      |
| Rated Transient Average .....      | $P$           | Maximum average power which may be dissipated due to a group of pulses occurring within a specified isolated time period, without causing device failure at 25 °C                                                                                                                                                                                                                                                                                                                                                                                                    |
| Power Dissipation                  |               |                                                                                                                                                                                                                                                                                                                                                                                                                                                                                                                                                                      |
| Capacitance.....                   | $C$           | Capacitance between two terminals of the varistor measured @ 1 kHz                                                                                                                                                                                                                                                                                                                                                                                                                                                                                                   |
| Non-linearity Exponent .....       | $\alpha$      | A measure of varistor nonlinearity between two given operating currents, $I_n$ and $I_1$ as described by $I = k V \exp(a)$ , where: <ul style="list-style-type: none"> <li>- <math>k</math> is a device constant,</li> <li>- <math>I_1 &lt; I &lt; I_n</math> and</li> <li>- <math>a \log(I_1/I_n) / \log(V_1/V_n) = 1 / \log(V_1/V_n)</math>, where:</li> <li>- <math>I_r</math> is reference current (1 mA) and <math>V_n</math> is varistor voltage</li> <li>- <math>I_1 = 10 I_n</math>, <math>V_1</math> is the voltage measured at <math>I_1</math></li> </ul> |
| Response Time.....                 | $t_r$         | The time lag between application of a surge and varistor's "turn-on" conduction action                                                                                                                                                                                                                                                                                                                                                                                                                                                                               |
| Varistor Voltage Temperature ..... | TC            | $(V_n @ 85 \text{ °C} - V_n @ 25 \text{ °C}) / (V_n @ 25 \text{ °C}) \times 60 \text{ °C} \times 100$                                                                                                                                                                                                                                                                                                                                                                                                                                                                |
| Coefficient                        |               |                                                                                                                                                                                                                                                                                                                                                                                                                                                                                                                                                                      |
| Insulation Resistance .....        | IR            | Minimum resistance between shorted terminals and varistor surface                                                                                                                                                                                                                                                                                                                                                                                                                                                                                                    |
| Isolation Voltage .....            |               | The maximum peak voltage which may be applied under continuous operating conditions between the varistor terminations and any conducting mounting surface                                                                                                                                                                                                                                                                                                                                                                                                            |
| Operating Temperature .....        |               | The range of ambient temperature for which the varistor is designed to operate continuously as defined by the temperature limits of its climatic category                                                                                                                                                                                                                                                                                                                                                                                                            |
| Climatic Category .....            | LCT/UCT/DHD   | LCT & UCT = Lower and Upper Category Temperature - the minimum and maximum ambient temperatures for which a varistor has been designed to operate continuously.<br>DHD = Dump Heat Test Duration                                                                                                                                                                                                                                                                                                                                                                     |
| Storage Temperature.....           |               | Storage temperature range without voltage applied                                                                                                                                                                                                                                                                                                                                                                                                                                                                                                                    |
| Current/Energy Derating.....       |               | Derating of maximum values when operated above UCT                                                                                                                                                                                                                                                                                                                                                                                                                                                                                                                   |

REV. C 09/20

Specifications are subject to change without notice.

Users should verify actual device performance in their specific applications.

The products described herein and this document are subject to specific legal disclaimers as set forth on the last page of this document, and at [www.bourns.com/docs/legal/disclaimer.pdf](http://www.bourns.com/docs/legal/disclaimer.pdf).

This legal disclaimer applies to purchasers and users of Bourns® products manufactured by or on behalf of Bourns, Inc. and its affiliates (collectively, “Bourns”).

Unless otherwise expressly indicated in writing, Bourns® products and data sheets relating thereto are subject to change without notice. Users should check for and obtain the latest relevant information and verify that such information is current and complete before placing orders for Bourns® products.

The characteristics and parameters of a Bourns® product set forth in its data sheet are based on laboratory conditions, and statements regarding the suitability of products for certain types of applications are based on Bourns’ knowledge of typical requirements in generic applications. The characteristics and parameters of a Bourns® product in a user application may vary from the data sheet characteristics and parameters due to (i) the combination of the Bourns® product with other components in the user’s application, or (ii) the environment of the user application itself. The characteristics and parameters of a Bourns® product also can and do vary in different applications and actual performance may vary over time. Users should always verify the actual performance of the Bourns® product in their specific devices and applications, and make their own independent judgments regarding the amount of additional test margin to design into their device or application to compensate for differences between laboratory and real world conditions.

Unless Bourns has explicitly designated an individual Bourns® product as meeting the requirements of a particular industry standard (e.g., ISO/TS 16949) or a particular qualification (e.g., UL listed or recognized), Bourns is not responsible for any failure of an individual Bourns® product to meet the requirements of such industry standard or particular qualification. Users of Bourns® products are responsible for ensuring compliance with safety-related requirements and standards applicable to their devices or applications.

Bourns® products are not recommended, authorized or intended for use in nuclear, lifesaving, life-critical or life-sustaining applications, nor in any other applications where failure or malfunction may result in personal injury, death, or severe property or environmental damage. Unless expressly and specifically approved in writing by two authorized Bourns representatives on a case-by-case basis, use of any Bourns® products in such unauthorized applications might not be safe and thus is at the user’s sole risk. Life-critical applications include devices identified by the U.S. Food and Drug Administration as Class III devices and generally equivalent classifications outside of the United States.

Bourns expressly identifies those Bourns® standard products that are suitable for use in automotive applications on such products’ data sheets in the section entitled “Applications.” Unless expressly and specifically approved in writing by two authorized Bourns representatives on a case-by-case basis, use of any other Bourns® standard products in an automotive application might not be safe and thus is not recommended, authorized or intended and is at the user’s sole risk. If Bourns expressly identifies a sub-category of automotive application in the data sheet for its standard products (such as infotainment or lighting), such identification means that Bourns has reviewed its standard product and has determined that if such Bourns® standard product is considered for potential use in automotive applications, it should only be used in such sub-category of automotive applications. Any reference to Bourns® standard product in the data sheet as compliant with the AEC-Q standard or “automotive grade” does not by itself mean that Bourns has approved such product for use in an automotive application.

Bourns® standard products are not tested to comply with United States Federal Aviation Administration standards generally or any other generally equivalent governmental organization standard applicable to products designed or manufactured for use in aircraft or space applications. Bourns expressly identifies Bourns® standard products that are suitable for use in aircraft or space applications on such products’ data sheets in the section entitled “Applications.” Unless expressly and specifically approved in writing by two authorized Bourns representatives on a case-by-case basis, use of any other Bourns® standard product in an aircraft or space application might not be safe and thus is not recommended, authorized or intended and is at the user’s sole risk.

The use and level of testing applicable to Bourns® custom products shall be negotiated on a case-by-case basis by Bourns and the user for which such Bourns® custom products are specially designed. Absent a written agreement between Bourns and the user regarding the use and level of such testing, the above provisions applicable to Bourns® standard products shall also apply to such Bourns® custom products.

Users shall not sell, transfer, export or re-export any Bourns® products or technology for use in activities which involve the design, development, production, use or stockpiling of nuclear, chemical or biological weapons or missiles, nor shall they use Bourns® products or technology in any facility which engages in activities relating to such devices. The foregoing restrictions apply to all uses and applications that violate national or international prohibitions, including embargos or international regulations. Further, Bourns® products and Bourns technology and technical data may not under any circumstance be exported or re-exported to countries subject to international sanctions or embargoes. Bourns® products may not, without prior authorization from Bourns and/or the U.S. Government, be resold, transferred, or re-exported to any party not eligible to receive U.S. commodities, software, and technical data.

To the maximum extent permitted by applicable law, Bourns disclaims (i) any and all liability for special, punitive, consequential, incidental or indirect damages or lost revenues or lost profits, and (ii) any and all implied warranties, including implied warranties of fitness for particular purpose, non-infringement and merchantability.

*For your convenience, copies of this Legal Disclaimer Notice with German, Spanish, Japanese, Traditional Chinese and Simplified Chinese bilingual versions are available at:*

*Web Page:* <http://www.bourns.com/legal/disclaimers-terms-and-policies>

*PDF:* <http://www.bourns.com/docs/Legal/disclaimer.pdf>

## Looking for pricing, stock, or lifecycle information?

Click below to explore more details on WIN SOURCE:

- [View ZV20K1206201NIR1 on WIN SOURCE](#)
- [Bourns Inc. Information](#)

## Optimize Your Supply Chain with WIN SOURCE Solutions

- ✓ Global Sourcing Solution
- ✓ Obsolete Management
- ✓ Cost Control Management
- ✓ Shortage Management
- ✓ Alternative Solution
- ✓ Excess Inventory Management