

850/851/852/853 Series Enclosed Fuse Holders for 5x20mm Fuses

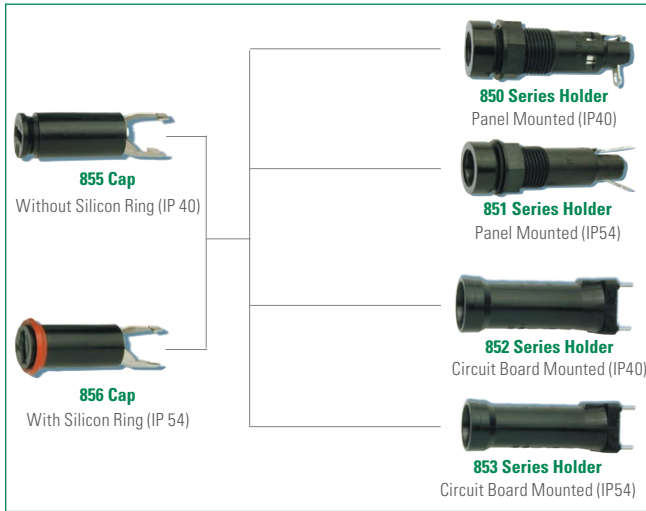

Agency Approval

Agency	Part Number			
	850	851	852	853
	Agency File Number			
	400345355		40033885	
	E70164			

Additional Information



Datasheet
850 Series



Resources
850 Series



Samples
850 Series



Datasheet
851 Series



Resources
851 Series



Samples
851 Series



Datasheet
852 Series



Resources
852 Series



Samples
852 Series



Datasheet
853 Series



Resources
853 Series



Samples
853 Series

Product Characteristics

	850/851 Series	852/853 Series
Compatible Fuse	5x20mm	
Materials	Holder: Black Thermoplastic Cap: Black Thermoplastic Both UL94V0 Sealing Ring: Silicon (Cap 856) Metal Parts: Copper alloy, corrosion protected Terminals: Solderable tinned	
Electrical Data (23°C)	Rated Voltage: 250V Rated Current: 10A (UL and VDE) Rated Current: 6.3A (VDE) / 12A (UL) Rated Power: 3.2W (VDE) Rated Power: 2W (VDE)	
Mounting	12.7mm diameter D-hole or 13mm round hole Admissible torque on plastic hex nut is 1.2Nm	(2) Solder pins 0.5mmx1.1mm
Terminals	Solderable only, 4mmx0.5mm (850) Solderable or 2.8mm quick connect - fits 0.5mm tab (851)	-
Protection Class & Category	IP 40 (with Cap 855 acc. to IEC 60529) IP 54 (with Cap 856 acc. to IEC 60529) PC2 (IEC 60127-6)	
Operating Temp.	-40°C to +85°C	
Climatic Test	-40°C/+85°C/21 days (IEC 60068-2-1...3)	
Stock Conditions	0°C to 60°C, Max 70% R.H.	
Contact Resistance	≤ 5mΩ at 20mV	
Impulse Voltage	4 kV, 50Hz, 1 min., dry	
Insulation Resistance	> 10 ³ MΩ (500VDC, 1 min.)	
Solderability	350°C/2 sec. acc to IEC 60068-2-20, Test Ta, method 2	235°C/2 sec. acc to IEC 60068-2-20, Test Tb, method 1
Soldering Heat Resistance	350°C/10 sec. acc to IEC 60068-2-20, Test Tb, method 2	260°C/10 sec. acc to IEC 60068-2-20, Test Tb, method 1A
Minimum Cross Section	Conductor - 1.5mm ²	Conducting path - 0.2mm ²
Marking	Part No., 250V, Approvals	
Unit Weight	4.1g (850) / 1.8g (855) 4.2g (851) / 1.9g (856)	3.2g (852) / 1.8g (855) 3.2g (853) / 1.9g (856)

Note: Refer to [Fuseology](#) for information on proper fuseholder re-rating.

Dimensions

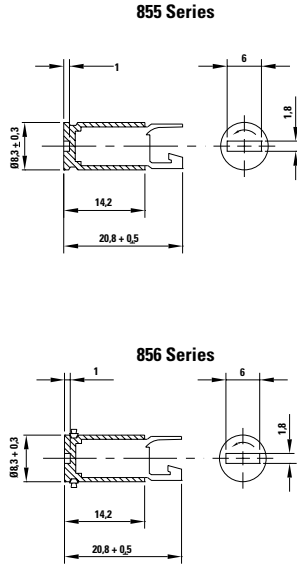
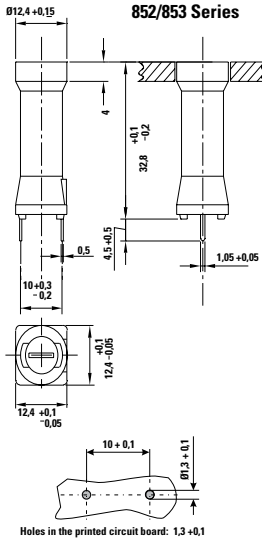
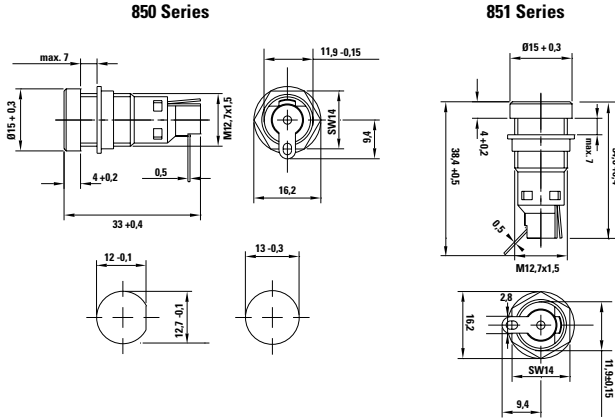

Ordering Information

Description	Ordering Number	Packaging
Cap, w/out ring (IP40)	85500001009	Bulk 100
Cap, w/silicon ring (IP54)	85600001009	Bulk 100
850 Series Holder (IP40)	85000001009	Bulk 100
851 Series Holder (IP54)	85100001009	Bulk 100
852 Series Holder (IP40)	85200001009	Bulk 100
853 Series Holder (IP54)	85300001009	Bulk 100

Looking for pricing, stock, or lifecycle information?

Click below to explore more details on WIN SOURCE:

 [View 85000001009 on WIN SOURCE](#)

 [Littelfuse Inc. Information](#)

Optimize Your Supply Chain with WIN SOURCE Solutions

-  Global Sourcing Solution
-  Obsolete Management
-  Cost Control Management
-  Shortage Management
-  Alternative Solution
-  Excess Inventory Management