

POTTER & BRUMFIELD W54 SERIES

PUSH TO RESET ONLY P&B THERMAL CIRCUIT BREAKER

FEATURES

- 5 to 40 amp ratings.
- Push button to reset breaker. Cannot be manually tripped.
- Button extends for visual trip indication.
- Numerous mounting and termination options.
- Optional bottom marking of amperage rating.



APPROVALS

- UL/cUL: Recognized with UL 1077 (Supplementary Protectors for Use in Electrical Equipment), File E69543 (excludes models rated >35A).
- VDE: Approved to DIN EN IEC 60934/VDE 0642 (Circuit Breaker for Equipment), Certificate No. 40059799 and 40007877 (for AC loads only).
- CCC: Approved to GB/T 17701, Certificate No. 2024010307738240 and 2004010307123217 (for AC loads only).



ELECTRICAL DATA @ 25°C

Calibration	Will continuously carry 100% of rating. May trip between 101% and 134%, but must trip at 135% of rating within one hour at +25°C.
Dielectric Strength	1,500VAC (60 seconds)
Insulation Resistance	100 megohms
Maximum Operating Voltages	50VDC; 250VAC
Interrupt Capacity	1,000 amps in accordance with UL standard 1077
Resettable Overload Capacity	Ten times rated current
Reset Time	60 seconds

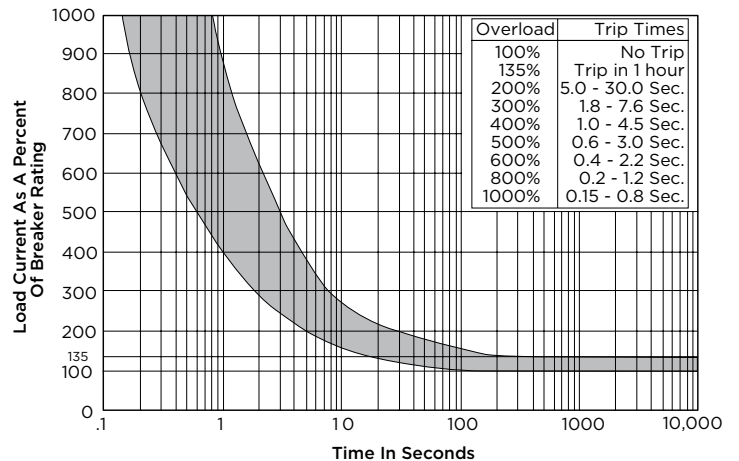

Note: Users should thoroughly review the technical data before selecting a product part number. It is recommended that users also seek out the pertinent approvals files of the agencies/laboratories and review them to confirm the product meets the requirements for a given application.

POTTER & BRUMFIELD W54 SERIES

Thermal Circuit Breaker

TYPICAL RESISTANCE VS. CURRENT RATING @25°C

Current Rating In Amps	Typical Resistance In Ohms	Current Rating In Amps	Typical Resistance In Ohms
5.0	0.050	15.0	0.017
6.0	0.042	20.0	0.012
7.0	0.036	25.0	0.010
8.0	0.031	30.0	0.008
10.0	0.025	35.0	0.007
12.0	0.021	40.0	0.006

AMBIENT COMPENSATION TABLE

Ambient Temperature In °C	Rating Correction Factor	
	5-8A Models	9-30A Models
10	.90	.80
20	.98	.90
25	1.00	1.00
30	1.10	1.05
40	1.25	1.15
50	1.61	1.31
60	2.00	1.55

To use this chart: Divide the breaker rating by the correction factor to determine the compensated rating. Calculate the overloads in terms of the compensated rating to use the published trip curve. Do not use these devices outside their specified operating temperature ranges.

MECHANICAL/ENVIRONMENTAL DATA

Operating Temperature Range	0°C to +60°C
Termination	.250in (6.35mm) quick connects or #8-32 screws
Mounting Various options.	See Ordering Information and drawings
Approximate Weight	0.9 oz. (25.0g)

OUTLINE DIMENSIONS

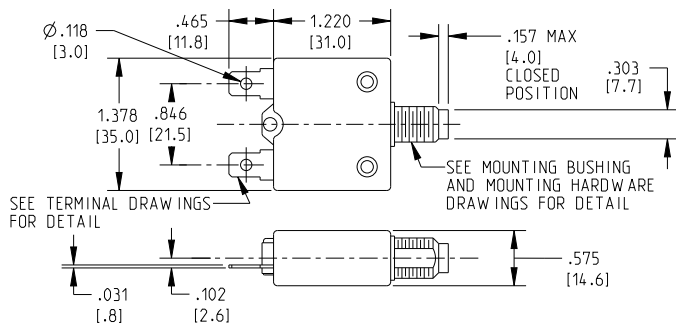

OPTIONAL PROTECTIVE BOOT

Silicone rubber boot is bonded to integral metal nut.

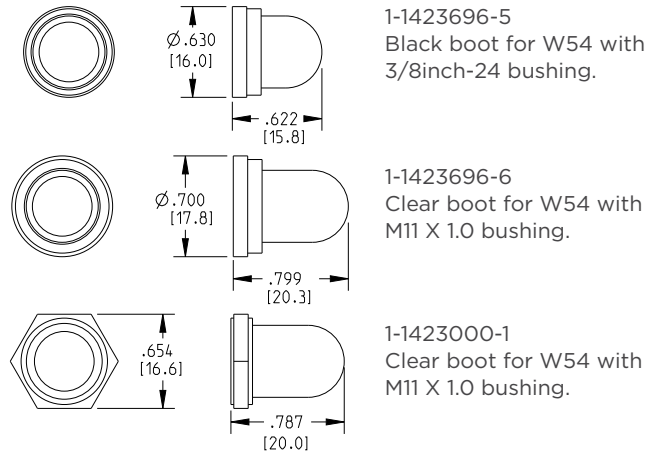

MOUNTING BUSHINGS AND RECOMMENDED PANEL CUTOUTS

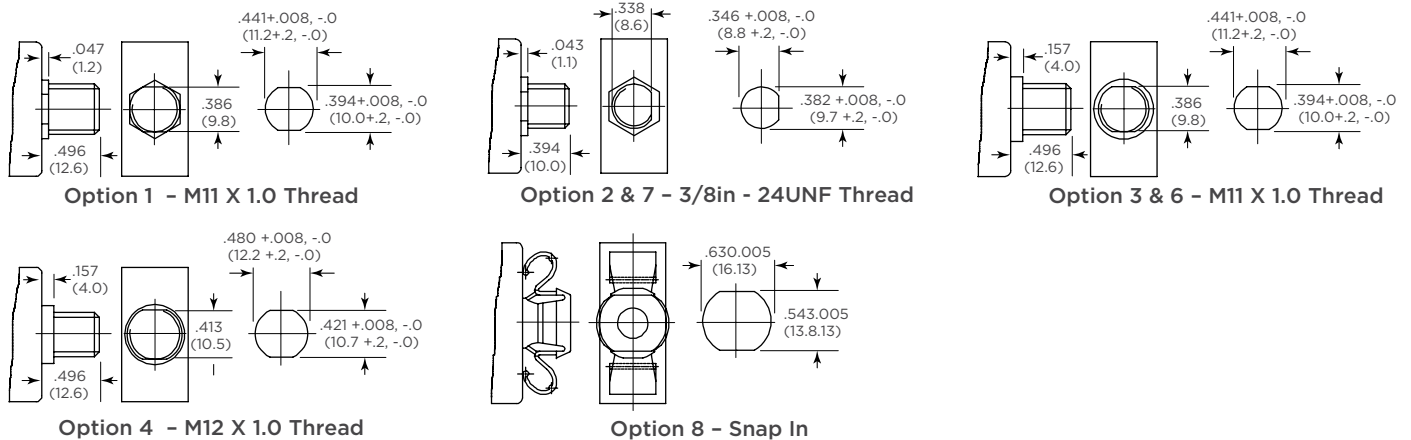

POTTER & BRUMFIELD W54 SERIES

Thermal Circuit Breaker

TERMINATION OPTIONS



Option A
Standard
.250 QC
Straight

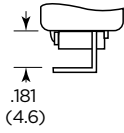

Option B
.250 QC
90°



Option C
#8-32 Screw
90°



Option D
Special
.250 QC
45°

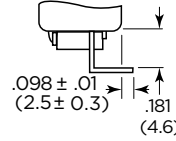

Option E
.250 QC/
PCB
270°



Option F
#8-32 Screw
45°

MOUNTING HARDWARE OPTIONS

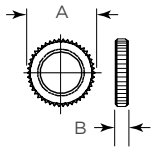

Knurled Nut

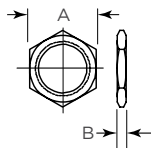

Hex Nut

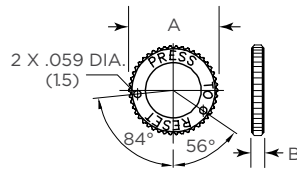

**Integrated Knurled Nut
with Small Holes**

ALTERNATE TEETH TWISTED
IN OPPOSITE DIRECTIONS

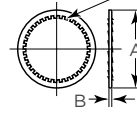

Lockwasher

NAMEPLATES

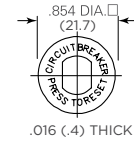

**Embossed
Aluminum**

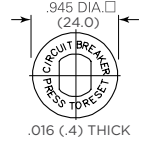

**Imprinted Aluminum
(Either Silver on Black
or Black on Silver)**

MOUNTING HARDWARE DIMENSIONS

Dimension Code	Bushing Diameter	Plastic Knurled Nut	Integrated Plastic Knurled Nut w/ Holes	Metal Knurled Nut	Metal Hex Nut	Lockwasher
A	3/8in	.74 (18.8)	-	.56 (14.2)	.55 (14.0)	.49 (12.5)
	M11	.74 (18.8)	.74 (18.8)	.59 (15.0)	.55 (14.0)	.587 (14.9)
	M12	-	-	.59 (15.0)	.55 (14.0)	.626 (15.9)
B	3/8in	.126 (3.2)	-	.079 (2.0)	.079 (2.0)	.02 (.5)
	M11	.126 (3.2)	.13 (3.3)	.102 (2.6)	.118 (3.0)	.02 (.5)
	M12	-	-	.102 (2.6)	.079 (2.0)	.02 (.5)

MOUNTING HARDWARE ORDERING INFORMATION

Dimension Code	Bushing Diameter	Plastic Knurled Nut	Integrated Plastic Knurled Nut w/ Holes	Metal Knurled Nut	Metal Hex Nut	Lockwasher
Metal	1 (M11)	-	-	6-1423730-3	6-1423730-7	1-1423696-2
	2 (3/8in)	-	-	6-1423730-4	6-1423730-6	1-1423696-1
	4 (M12)	-	-	6-1423730-5	6-1423730-8	1-1423696-3
Plastic	6 (M11)	1423696-8	2-1423696-2	-	-	-
	8 (3/8in)	1423696-2	-	-	-	-

ORDERING NOTE:

Mounting hardware can be ordered separately. Some options are subject to extended leadtimes and significant minimum order quantities.

PRODUCT CODE STRUCTURE

Typical product code
W 54 -X B 1 A 4 A 1 0 -5

Designator

W	Circuit breaker
----------	-----------------

Series Number

54	Single pole, push-to-reset, thermal model
-----------	---

Circuit Function & Contact Material

X	Series trip, silver-cadmium oxide contacts (VDE covers up to 20A, CCC covers up to 30A)
F	Series trip, silver-tin oxide contacts

Number of NC contact configurations

A	White, plain, no rate marking
B	White with rate marking (vertical)
D	Black, plain, no rate marking
E	Black with rate marking (horizontal)
F	White with rate marking (horizontal)
H	Black with rate marking (vertical)
I	Red, plain, no rate marking

Mounting Bushing

Metal	
1	9.8mm (double D) x 12.6mm long, M11x1 threads, hex base
2	3/8in (single D) x 10mm long, 3/8inx24 threads, hex base
3	9.8mm (double D) x 12.6mm long, M11x1 threads, round base
4	10.5mm (double D) x 12.6mm long, M12x1 threads, round base
Plastic	
6	9.8mm (double D) x 12.6mm long, M11x1 threads, round base
7	3/8in (single D) x 10mm long, 3/8inx24 threads, hex base
8	Snap-in type

Codes 1, 3 and 5 are similar in size to 7/16in bushings (not exact equivalent).

Code 4 is similar in size to a 15/32in bushing (not exact equivalent)

Specify Amp Rating

5	10	25[†]
6	12	30[†]
7	15	35[†]
8	20	40[†]

[†]not UL/cUL

Nameplate

0	None
1	Embossed aluminum
2	Silver color printing on black
3	Black printing on silver color

Maximum Operating Voltage

1	250VAC / 50VDC*
2	125VAC / 50VDC*

*DC rating apply to UL only

Mounting Hardware Packaging

A	Assembled to bushing
B	Bulk unassembled
C	No mounting hardware

Mounting Hardware

Metal	
4	Knurled nut/hex nut
6	Hex nut
12	Knurled nut
15	Two hex nuts and one lockwasher
18	One hex nut and one lockwasher
Plastic	
7	Knurled nut
8	Knurled nut with small hole
22	Knurled nut, metal lockwasher
99	None

Terminals

A	Quick connect .250in (6.35mm), straight
B	Quick connect .250in (6.35mm), bent 90°
C	#8-32 screw, bent 90° (screws installed)
D	Quick connect .250in (6.35mm), bent 45°
E	Quick connect .250in (6.35mm), bent 90° opposite
F	#8-32 screw, bent 45° (screws installed)

te.com

©2025 TE Connectivity plc Family of Companies. All Rights Reserved.

TE Connectivity, TE connectivity (logo) and Every Connection Counts are trademarks owned or licensed by the TE Connectivity plc family of companies. All other logos, products and/or company names referred to herein might be trademarks of their respective owners.

While TE has made every reasonable effort to ensure the accuracy of the information in this document, TE does not guarantee that it is error-free, nor does TE make any other representation, warranty or guarantee that the information is accurate, correct, reliable or current. TE reserves the right to make any changes to the information contained herein without prior notice. TE Connectivity assumes only those obligations set forth in the terms and conditions for this product and shall in no event be liable for any incidental, indirect, or consequential damages arising out of the sale, resale, use, or misapplication of the product. TE expressly disclaims any implied warranties with respect to the information contained herein, including, but not limited to, implied warranties of merchantability or fitness for a particular purpose. Dimensions, specifications and/or information contained herein are for reference purposes only and are subject to change without notice. Consult TE for the latest dimensions, specifications and/or information. Users of TE Connectivity products must make their own assessment as to whether the respective product is suitable for the respective desired application.

07/25 ED



Looking for pricing, stock, or lifecycle information?

Click below to explore more details on WIN SOURCE:

 [View W54-XB1A4A10-35](#) on WIN SOURCE

 [TE Connectivity](#) Information

Optimize Your Supply Chain with WIN SOURCE Solutions

-  Global Sourcing Solution
-  Obsolete Management
-  Cost Control Management
-  Shortage Management
-  Alternative Solution
-  Excess Inventory Management