

W33 series

One- and Two-Pole, Switchable Thermal Circuit Breaker / Power Switch With Optional Indicator Lamp



Features

- Combines on/off switch and circuit protection in a single unit.
- 2 to 20 amp ratings (<2A types available as special order).
- One or two pole sensing.
- Lighted or non-lighted rocker actuator in various colors.
- Convenient, snap-in mounting.
- Optional auxiliary switch available.
- Trip-free operation.

Agency Approvals

W33 series is UL 1077 Recognized as Supplementary Protectors, File E69543, and CSA Accepted as Supplementary Protectors (Appliance Component Protectors), File LR15734.

Users should thoroughly review the technical data before selecting a product part number. It is recommended that users also seek out the pertinent approvals files of the agencies/laboratories and review them to ensure the product meets the requirements for a given application.

Electrical Data @ 25°C

Calibration: Breaker will continuously carry 100% of rated load. It may trip between 101% and 135%, but must trip at 135% within one hour at +25°C.

Dielectric Strength: Over 2,000 volts RMS.

Maximum Operating Voltages: 50VDC; 250VAC to 400 Hz.

Interrupt Capacity: 1,000 amps at 50VDC; 250VAC, 60 Hz. and 125/250VAC, 400 Hz.
1,500 amps at 125/250VAC, 60 Hz.

Resettable Overload Capacity: Ten times rated current.

Mechanical/Environmental Data

Termination: Poles 1&2: .250" (6.35mm) quick connect/solder terminals.

Opt. Aux. Sw.: .110" (2.79mm) quick connect terminals.

Mounting: Snaps into panel from front.

Actuator: Rocker or lighted rocker.

Shock: 30g tested to IEC 68-2-27, test Ea.

Vibration: 8g tested to IEC 68-2-6, test Fc.

Switch Endurance Cycling: 50,000 operations at rated load.
1,000 operations at 200% rated load.

Time vs. Current Trip Curve @ +25°C

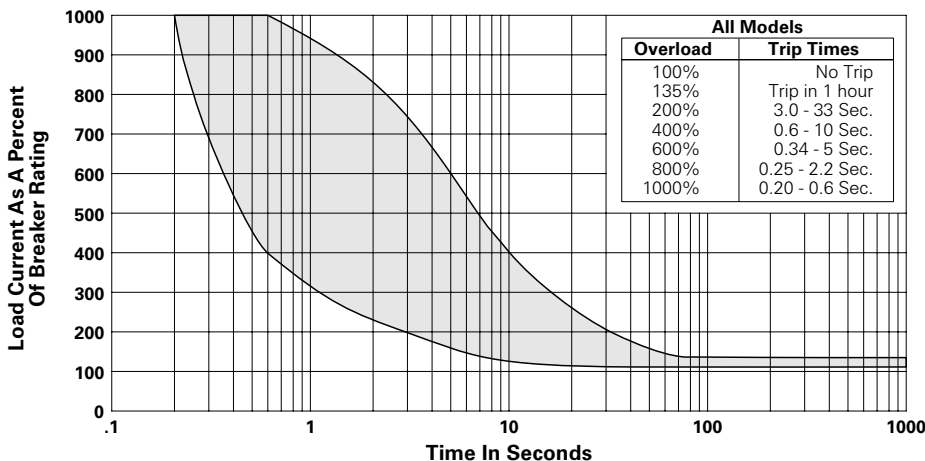

Ambient Compensation Chart

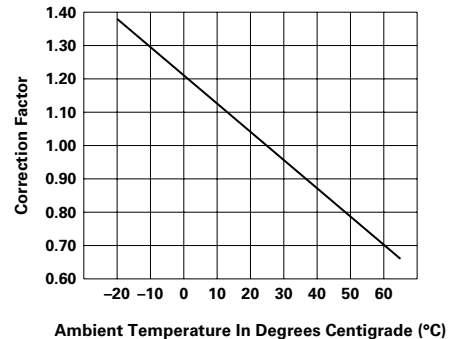

To use this chart: Read up from the ambient temperature to the curve, and across to find a correction factor. Multiply the breaker rating by the correction factor to determine the compensated rating. Calculate the overloads in terms of the compensated rating to use the published trip curve.

Ordering Information

Typical Part No. ▶

W 33 -S 1 N 1 Q -20

1. Designator:

W = Circuit breaker

2. Series Number:

33 = Two pole, rocker actuated

3. Circuit Function:

S = Pole 1 – Switch only; Pole 2 – Series trip overload sensing.
T = Poles 1 & 2 – Series trip overload sensing.
SS = Same as S with auxiliary switch on pole 1.
TS = Same as T with auxiliary switch on pole 1.
D = 2 Pole switching.

4. Rocker Color:

1 = Black. 2 = White. 3 = Red. 4 = Amber. 5 = Smoke.

5. Light (available only with White, Red, Amber and Smoke rocker colors):

A = 24VDC (Incandescent). B = 120VAC (Neon with resistor). C = 240VAC (Neon with resistor). N = No light.

6. Marking:

1 = International I/O. 2 = Contrasting I/O stamp (white toggle with black stamp).

7. Termination:

Q = .250" x .032" (6.35 x .813mm) quick connect / solder terminals.

8. Amp Rating:

2 5 7 10 12 15 16 20

Consult factory for availability of ratings <2A

Stock Items – Authorized distributors are more likely to stock the following items.

W33-S1N1Q-5	W33-S4B1Q-10	W33-T4B1Q-5
W33-S1N1Q-15	W33-S4B1Q-15	W33-T4B1Q-10
W33-S1N1Q-20	W33-T2N1Q-20	W33-T4B1Q-15

Outline Dimensions

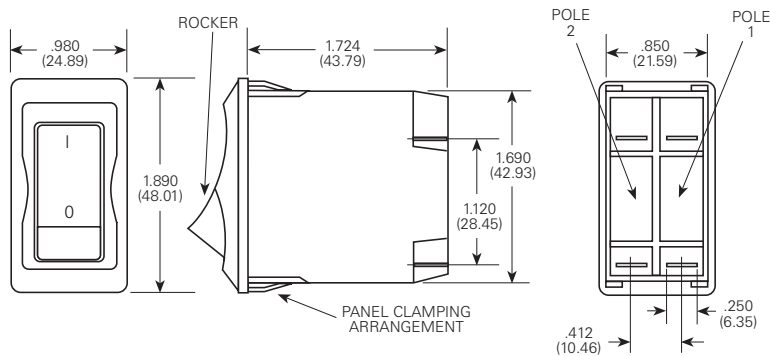

FITS .875 x 1.750 (22.22 x 44.45) PANEL OPENING
FROM .032" - .250" (.813mm - 6.35mm) THICK

Schematic

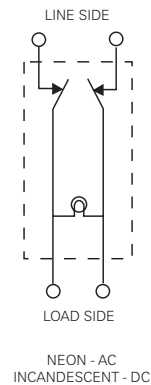

Looking for pricing, stock, or lifecycle information?

Click below to explore more details on WIN SOURCE:

 [View W33-S1N1Q-5](#) on WIN SOURCE

 [TE Connectivity](#) Information

Optimize Your Supply Chain with WIN SOURCE Solutions

-  Global Sourcing Solution
-  Obsolete Management
-  Cost Control Management
-  Shortage Management
-  Alternative Solution
-  Excess Inventory Management