

HLMP-1301, HLMP-1401, HLMP-1503, HLMP-K401, HLMP-K600

T-1 (3-mm) Diffused LED Lamps



Description

This family of T-1 lamps is widely used in general-purpose indicator applications. Diffusants, tints, and optical design are balanced to yield superior light output and wide viewing angles. Several intensity choices are available in each color for increased design flexibility.

Features

- High intensity
- Choice of four bright colors:
 - Red
 - Orange
 - Yellow
 - Green
- Popular T-1 diameter package
- Selected minimum intensities
- Wide viewing angle
- General purpose leads
- Reliable and rugged
- Available on tape and reel

Package Dimensions

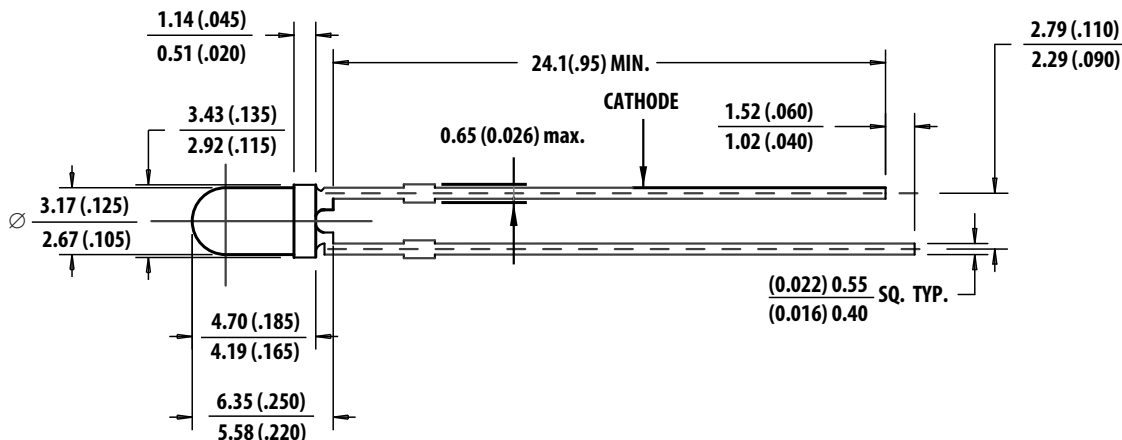

NOTE:

1. All dimensions are in mm (inches).
2. An epoxy meniscus may extend about 1 mm (0.040 in.) down the leads.
3. For PCB hole recommendations, see [Precautions](#).

Device Selection Guide

Material	Color	Part Number	Luminous Intensity I_v (mcd) at 10 mA	
			Min.	Max.
AlInGaP	Red	HLMP-1301	3.4	—
		HLMP-1301-E00xx	3.4	—
		HLMP-1301-G00xx	8.6	—
	Yellow	HLMP-1401	2.2	—
		HLMP-1401-D00xx	3.6	—
		HLMP-1401-E0000	5.7	—
	Orange	HLMP-K401	2.1	—
		HLMP-K401-E00xx	3.4	—
	Green	HLMP-1503	1.0	—
		HLMP-1503-C00xx	2.6	—
		HLMP-1503-D00xx	4.2	—
		HLMP-1503-E00xx	6.7	—
	Emerald Green	HLMP-K600	1.0	—

Absolute Maximum Ratings at $T_A = 25^\circ\text{C}$

Parameter	Red/Orange	Yellow	Green	Units
Peak Forward Current	90	60	90	mA
Average Forward Current ^a	25	20	25	mA
DC Current ^{b, c}	30	20	30	mA
Reverse Voltage ($I_R = 100 \mu\text{A}$)	5	5	5	V
LED Junction Temperature	110	110	110	$^\circ\text{C}$
Operating Temperature Range	-40 to +100	-40 to +100	-20 to +100	$^\circ\text{C}$
Storage Temperature Range	-40 to +100	-40 to +100	-40 to +100	$^\circ\text{C}$

a. See [Figure 4](#) (Red/Orange), [Figure 8](#) (Yellow), or [Figure 12](#) (Green/Emerald Green) to establish pulsed operating conditions.

b. For Red, Orange, and Green series, derate linearly from 50°C at $0.5 \text{ mA}/^\circ\text{C}$. For Yellow series, derate linearly from 50°C at $0.2 \text{ mA}/^\circ\text{C}$.

c. For Red, Orange, and Green series, derate power linearly from 25°C at $1.8 \text{ mW}/^\circ\text{C}$. For Yellow series, derate power linearly from 50°C at $1.6 \text{ mW}/^\circ\text{C}$.

Electrical/Optical Characteristics at $T_A = 25^\circ\text{C}$

Parameter	Symbol	Device	Min.	Typ.	Max.	Units	Test Conditions
Included Angle Between Half Luminous Intensity Points	$2\theta_{1/2}$	All	—	60	—	Deg.	$I_F = 10 \text{ mA}$, See Note ^a
Peak Wavelength	λ_{PEAK}	Red	—	632	—	nm	Measurement at Peak
		Orange	—	610	—		
		Yellow	—	590	—		
		Green	—	570	—		
		Emerald Green	—	560	—		
Dominant Wavelength	λ_d	Red	—	626	—	nm	See Note ^b
		Orange	—	605	—		
		Yellow	—	589	—		
		Green	—	569	—		
		Emerald Green	—	559	—		
Spectral Line Halfwidth	$\Delta\lambda_{1/2}$	Red	—	14	—	nm	
		Orange	—	13	—		
		Yellow	—	12	—		
		Green	—	13	—		
		Emerald Green	—	13	—		
Speed of Response	τ_s	Red	—	90	—	ns	
		Orange	—	280	—		
		Yellow	—	90	—		
		Green	—	500	—		
		Emerald Green	—	3100	—		
Capacitance	C	Red	—	11	—	pF	$V_F = 0$; $f = 1 \text{ MHz}$
		Orange	—	4	—		
		Yellow	—	15	—		
		Green	—	18	—		
		Emerald Green	—	35	—		
Thermal Resistance	$R\theta_{\text{J-PIN}}$	All	—	290	—	$^\circ\text{C/W}$	Junction to Cathode Lead
Forward Voltage	V_F	Red/Orange	1.5	1.9	2.4	V	$I_F = 10 \text{ mA}$
		Yellow	1.5	1.9	2.4		
		Green	1.5	2.0	2.7		
		Emerald Green	—	2.1	2.7		
Reverse Breakdown Voltage	V_R	All	5.0	—	—	V	$I_R = 100 \mu\text{A}$
Luminous Efficacy	η_V	Red	—	180	—	lumens/ watt	See Note ^c
		Orange	—	350	—		
		Yellow	—	500	—		
		Green	—	640	—		
		Emerald Green	—	660	—		

a. $\theta_{1/2}$ is the off-axis angle at which the luminous intensity is half the axial luminous intensity.

b. The dominant wavelength, λ_d , is derived from the CIE chromaticity diagram and represents the single wavelength that defines the color of the device.

c. Radiant intensity, I_e , in watts/steradian, may be found from the equation $I_e = I_v/\eta_V$, where I_v is the luminous intensity in candelas and η_V is the luminous efficacy in lumens/watt.

Part Numbering System

H L M P -

x ₁	x ₂	x ₃	x ₄
----------------	----------------	----------------	----------------

 -

x ₅	x ₆	x ₇	x ₈	x ₉
----------------	----------------	----------------	----------------	----------------

Code	Description	Option	
x ₁	Package type	1	T-1 (3 mm)
		K	T-1 (3 mm)
x ₂	Color	3	Red
		4	Yellow (except K4xx series)
		5	Green
		6	Emerald Green
x ₃ x ₄	Product specific designation	—	
x ₅	Minimum intensity bin	See Table 1, Intensity Bin Limits	
x ₆	Maximum intensity bin		
x ₇	Color bin selection	0	Full range
x ₈ x ₉	Packaging option	00	Bulk packaging
		02	Tape and Reel, Straight Leads
		A1	Right Angle Housing, Uneven Leads
		A2	Right Angle Housing, Even Leads
		FG	Products need inventory control for customer IDI

Intensity Bin Limits

Table 1: Intensity Bin Limits

Color	Bin	Intensity Range (mcd)	
		Min.	Max.
Red/Orange	D	2.4	3.8
	E	3.8	6.1
	F	6.1	9.7
	G	9.7	15.5
	H	15.5	24.8
	I	24.8	39.6
	J	39.6	63.4
	K	63.4	101.5
	L	101.5	162.4
	M	162.4	234.6
	N	234.6	340.0
	O	340.0	540.0
	P	540.0	850.0
	Q	850.0	1200.0
	R	1200.0	1700.0
	S	1700.0	2400.0
	T	2400.0	3400.0
	U	3400.0	4900.0
	V	4900.0	7100.0
	W	7100.0	10200.0
X	10200.0	14800.0	
Y	14800.0	21400.0	
Z	21400.0	30900.0	

Table 1: Intensity Bin Limits (Continued)

Color	Bin	Intensity Range (mcd)	
		Min.	Max.
Yellow	C	2.5	4.0
	D	4.0	6.5
	E	6.5	10.3
	F	10.3	16.6
	G	16.6	26.5
	H	26.5	42.3
	I	42.3	67.7
	J	67.7	108.2
	K	108.2	173.2
	L	173.2	250.0
	M	250.0	360.0
	N	360.0	510.0
	O	510.0	800.0
	P	800.0	1250.0
	Q	1250.0	1800.0
	R	1800.0	2900.0
	S	2900.0	4700.0
	T	4700.0	7200.0
	U	7200.0	11700.0
	V	11700.0	18000.0
W	18000.0	27000.0	

Table 1: Intensity Bin Limits (Continued)

Color	Bin	Intensity Range (mcd)	
		Min.	Max.
Green/Emerald Green	A	1.1	1.8
	B	1.8	2.9
	C	2.9	4.7
	D	4.7	7.6
	E	7.6	12.0
	F	12.0	19.1
	G	19.1	30.7
	H	30.7	49.1
	I	49.1	78.5
	J	78.5	125.7
	K	125.7	201.1
	L	201.1	289.0
	M	289.0	417.0
	N	417.0	680.0
	O	680.0	1100.0
	P	1100.0	1800.0
	Q	1800.0	2700.0
	R	2700.0	4300.0
	S	4300.0	6800.0
T	6800.0	10800.0	
U	10800.0	16000.0	
V	16000.0	25000.0	
W	25000.0	40000.0	

NOTE: Maximum tolerance for each bin limit is ± 18%.

NOTE: All categories are established for classification of products. Products may not be available in all categories. Contact your local Broadcom® representative for further clarification or information.

Color Categories

Color	Category #	Lambda (nm)	
		Min.	Max.
Emerald Green	9	522.5	555.5
	8	555.5	558.5
	7	558.5	561.5
	6	561.5	564.5
Green	6	561.5	564.5
	5	564.5	567.5
	4	567.5	570.5
	3	570.5	573.5
	2	573.5	576.5
Yellow	1	582.0	584.5
	3	584.5	587.0
	2	587.0	589.5
	4	589.5	592.0
	5	592.0	593.0
Orange	1	597.0	599.5
	2	599.5	602.0
	3	602.0	604.5
	4	604.5	607.5
	5	607.5	610.5
	6	610.5	613.5
	7	613.5	616.5
	8	616.5	619.5

NOTE: Tolerance for each bin limit is ± 0.5 nm.

Packaging Option Matrix

Packaging Option Code	Definition
00	Bulk Packaging, minimum increment, 500 pieces/bag
02	Tape and Reel, straight leads, minimum increment, 1800 pieces/bag
A1	Right-Angle Housing, uneven leads, minimum increment, 500 pieces/bag
A2	Right-Angle Housing, even leads, minimum increment, 500 pieces/bag
FG	Inventory Control for Customer IDI

Figure 1: Relative Intensity vs. Wavelength

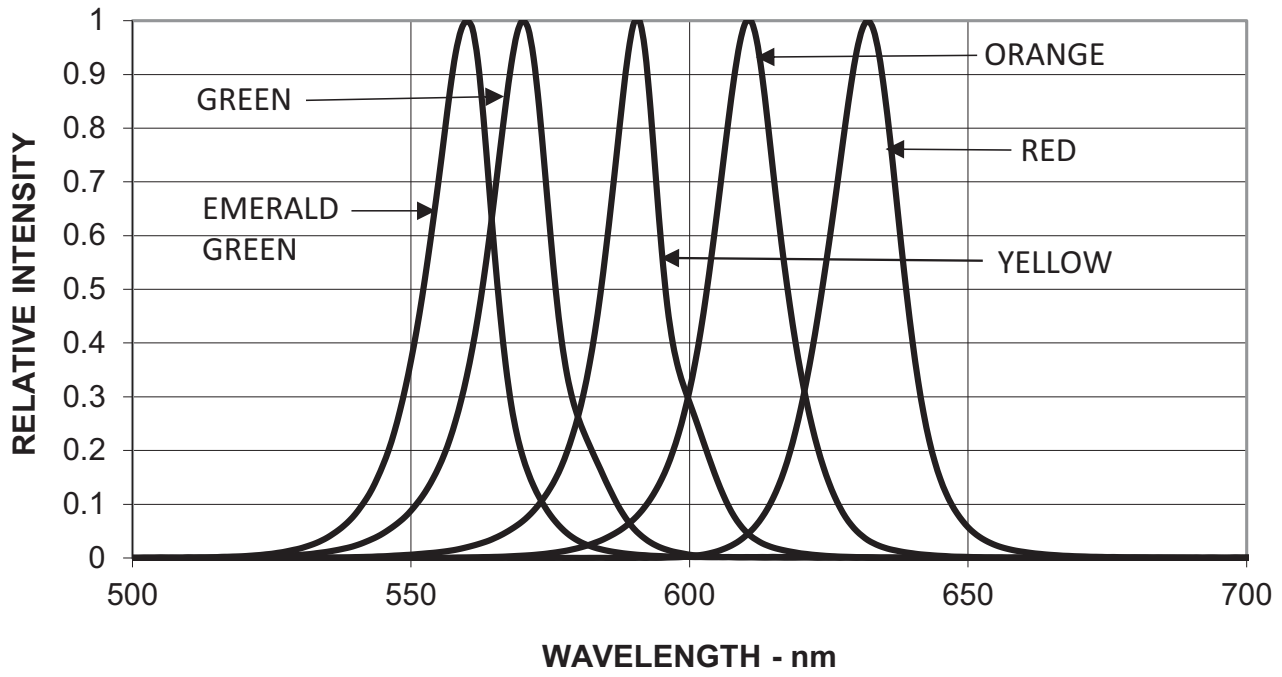

T-1 Red, Orange Diffused Lamps

Figure 2: Forward Current vs. Forward Voltage Characteristics

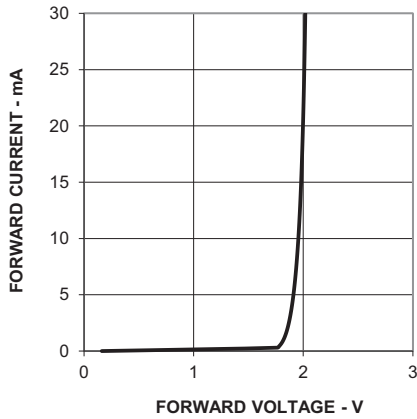

Figure 3: Relative Luminous Intensity vs. DC Forward Current

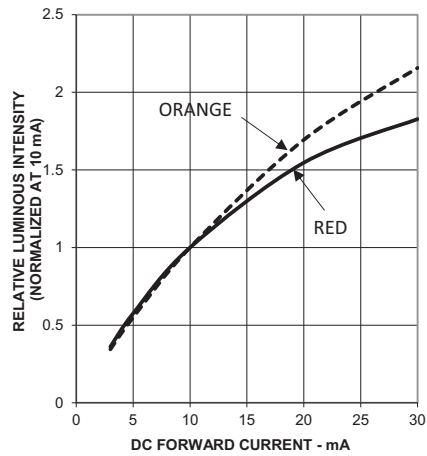

Figure 4: Maximum Tolerable Peak Current vs. Pulse Duration ($I_{DC\ MAX}$ as per MAX Ratings)

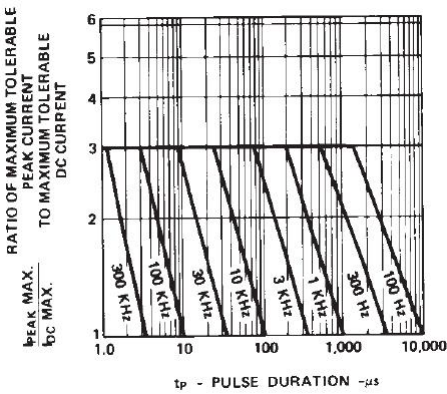
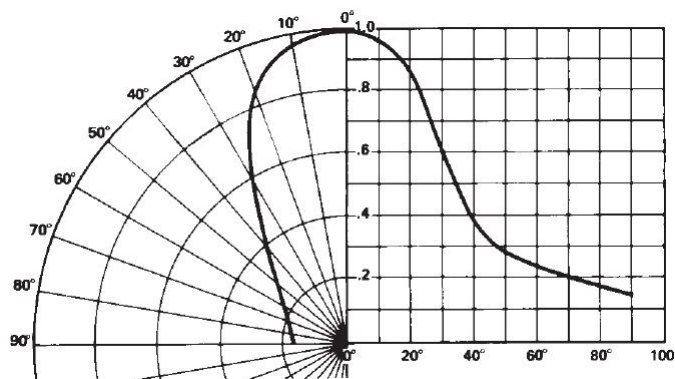

Figure 5: Relative Luminous Intensity vs. Angular Displacement



T-1 Yellow Diffused Lamps

Figure 6: Forward Current vs. Forward Voltage Characteristics

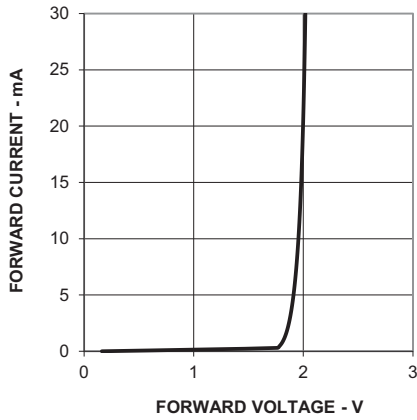

Figure 7: Relative Luminous Intensity vs. Forward Current

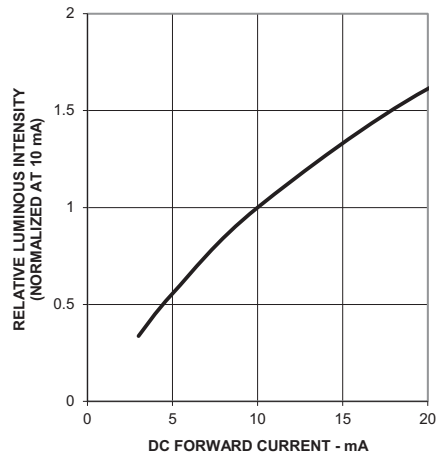

Figure 8: Maximum Tolerable Peak Current vs. Pulse Duration ($I_{DC\ MAX}$ as per MAX Ratings)

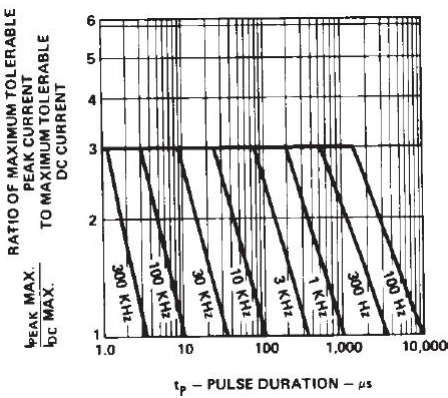
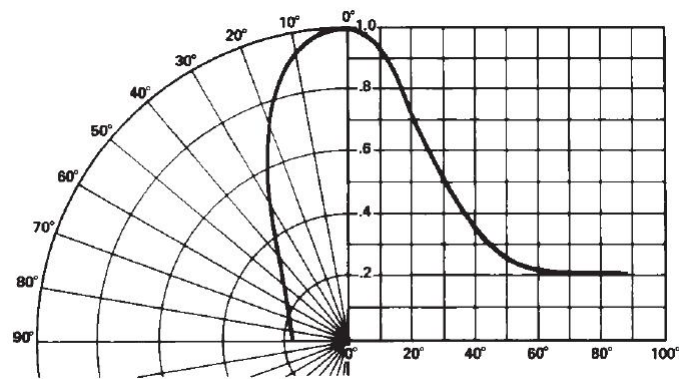

Figure 9: Relative Luminous Intensity vs. Angular Displacement



T-1 Green/Emerald Green Diffused Lamps

Figure 10: Forward Current vs. Forward Voltage Characteristics

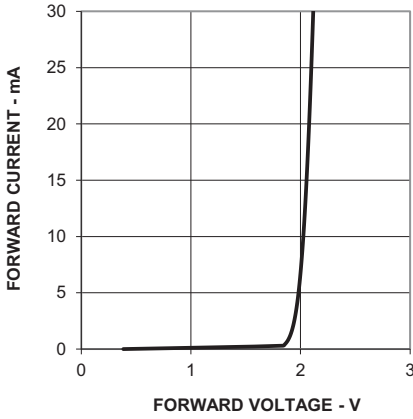

Figure 11: Relative Luminous Intensity vs. Forward Current

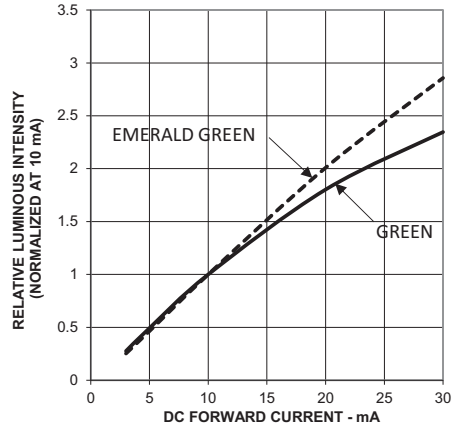

Figure 12: Maximum Tolerable Peak Current vs. Pulse Duration ($I_{DC\ MAX}$ as per MAX Ratings)

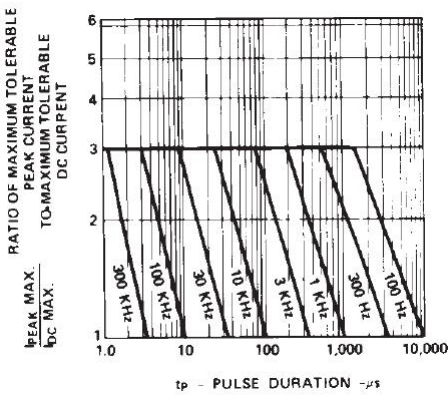
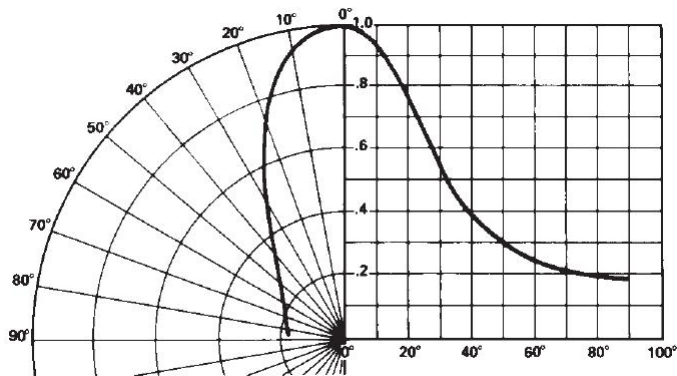

Figure 13: Relative Luminous Intensity vs. Angular Displacement



Precautions

Lead Forming

- The leads of an LED lamp may be preformed or cut to length prior to insertion and soldering on PC board.
- For better control, use the proper tool to precisely form and cut the leads to applicable length rather than doing it manually.
- If manual lead cutting is necessary, cut the leads after the soldering process. The solder connection forms a mechanical ground that prevents mechanical stress due to lead cutting from traveling into LED package. Use this method for the hand soldering operation, because the excess lead length also acts as small heat sink.

Soldering and Handling

- Take care during the PCB assembly and soldering process to prevent damage to the LED component.
- LED component may be effectively hand soldered to PCB. However, do this under unavoidable circumstances, such as rework. The closest manual soldering distance of the soldering heat source (soldering iron’s tip) to the body is 1.59 mm. Soldering the LED using soldering iron tip closer than 1.59 mm might damage the LED.

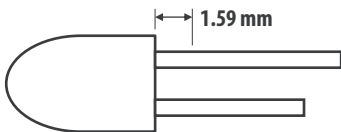

- Apply ESD precautions on the soldering station and personnel to prevent ESD damage to the LED component that is ESD sensitive. Refer to Broadcom application note AN 1142 for details. The soldering iron used must have a grounded tip to ensure electrostatic charge is properly grounded.
- Recommended soldering condition.

	Wave Soldering ^{a, b}	Manual Solder Dipping
Pre-heat Temperature	105°C max.	—
Pre-heat Time	60s max.	—
Peak Temperature	250°C max.	260°C max.
Dwell Time	3s max.	5s max.

- The preceding conditions refer to measurement with a thermocouple mounted at the bottom of the PCB.
- Use only bottom pre-heaters to reduce thermal stress experienced by LED.

- Set and maintain wave soldering parameters according to the recommended temperature and dwell time. Perform daily checks on the soldering profile to ensure that it always conforms to the recommended soldering conditions.

NOTE:

- PCBs with different size and design (component density) will have a different heat mass (heat capacity). This might cause a change in temperature experienced by the board if the same wave soldering setting is used. Therefore, recalibrate the soldering profile again before loading a new type of PCB.
 - Take extra precautions during wave soldering to ensure that the maximum wave temperature does not exceed 250°C and the solder contact time does not exceed 3s. Over-stressing the LED during the soldering process might cause premature failure to the LED due to delamination.
- Loosely fit any alignment fixture that is being applied during wave soldering and do not apply weight or force on the LED. Use nonmetal material because it absorbs less heat during the wave soldering process.
 - At elevated temperature, LED is more susceptible to mechanical stress. Therefore, allow the PCB to cool down to room temperature prior to handling, which includes removal of alignment fixture or pallet.
 - If PCB board contains both through-hole (TH) LED and other surface-mount components, solder surface-mount components on the top side of the PCB. If the surface mount must be on the bottom side, solder these components using reflow soldering prior to the insertion of the TH LED.
 - The recommended PC board plated through holes (PTH) size for LED component leads follows.

	LED Component Lead Size	Diagonal	Plated Through-Hole Diameter
Lead size (typ.)	0.45 × 0.45 mm (0.018 × 0.018 in.)	0.636 mm (0.025 in.)	0.98 to 1.08 mm (0.039 to 0.043 in.)
Dambar shear-off area (max.)	0.65 mm (0.026 in.)	0.919 mm (0.036 in.)	
Lead size (typ.)	0.50 × 0.50 mm (0.020 × 0.020 in.)	0.707 mm (0.028 in.)	1.05 to 1.15 mm (0.041 to 0.045 in.)
Dambar shear-off area (max.)	0.70 mm (0.028 in.)	0.99 mm (0.039 in.)	

NOTE: Refer to application note AN1027 for more information on soldering LED components.

- Over-sizing the PTH can lead to twisted LED after clinching. On the other hand, under-sizing the PTH can cause difficulty inserting the TH LED.

Figure 14: Example of Wave Soldering Temperature Profile for TH LED

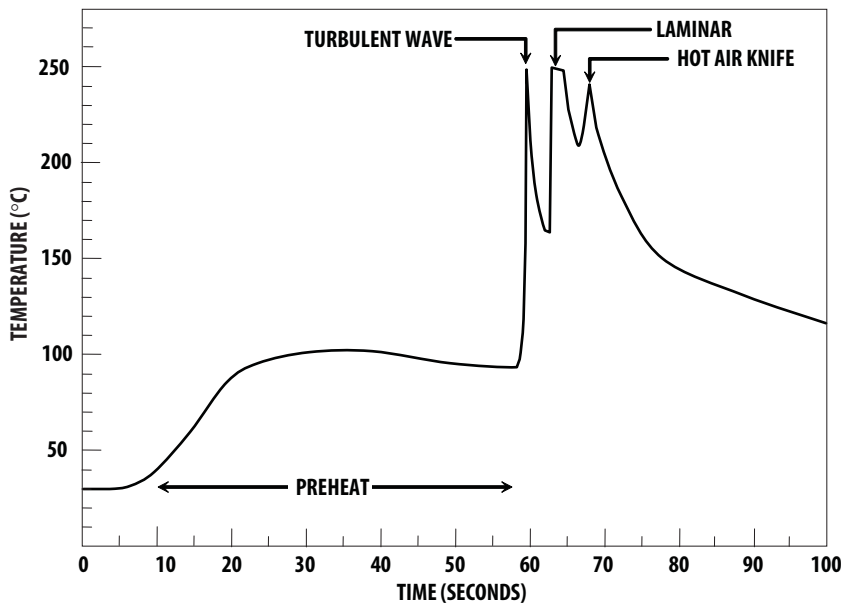

Recommended solder:
 Sn63 (Leaded solder alloy)
 SAC305 (Lead-free solder alloy)

Flux: Rosin flux

Solder bath temperature:
 245°C ± 5 °C (maximum peak temperature = 250°C)

Dwell time: 1.5s – 3.0s (maximum = 3 seconds)

Note: Allow for board to be sufficiently cooled to room temperature before you exert mechanical force.

Copyright © 2017–2023 Broadcom. All Rights Reserved. The term “Broadcom” refers to Broadcom Inc. and/or its subsidiaries. For more information, please visit www.broadcom.com. All trademarks, trade names, service marks, and logos referenced herein belong to their respective companies.



Broadcom reserves the right to make changes without further notice to any products or data herein to improve reliability, function, or design. Information furnished by Broadcom is believed to be accurate and reliable. However, Broadcom does not assume any liability arising out of the application or use of this information, nor the application or use of any product or circuit described herein, neither does it convey any license under its patent rights nor the rights of others.



Lead (Pb) Free
RoHS Compliant

Looking for pricing, stock, or lifecycle information?

Click below to explore more details on WIN SOURCE:

-  [View HLMP-1401-D00A1 on WIN SOURCE](#)
-  [Broadcom Limited Information](#)

Optimize Your Supply Chain with WIN SOURCE Solutions

-  Global Sourcing Solution
-  Obsolete Management
-  Cost Control Management
-  Shortage Management
-  Alternative Solution
-  Excess Inventory Management