

SGX-VOX Datasheet

0-100% Oxygen (O₂) Sensor with on board temperature compensation. For ventilators.

PERFORMANCE

Output signal	9-13mV in Air*
Zero current (offset)	<0.1% O ₂
T90 response time	< 5 seconds
T99.5 response time	<50 sec
Measurement Range	0-100% O ₂
Linearity	Linear
Temp. Compensation (0-40°C)	< 2% O ₂
Recommended Load Resistor	min 10k Ohms

* measured in standard temperature and pressure (20°C, 50%RH and 1atm)

OPERATING CONDITIONS

Temperature Range	-20°C to +50°C
Pressure Range	500 to 2000 mbar
Operating Humidity Range	0% to 99% RH (non condensing)

LIFETIME

Long Term Output Drift	<5% per annum
Recommended Storage Temp	0°C to 20°C
Expected Operating Life	375000% O ₂ hrs at 20°C

OUTLINE

All dimensions are in mm
 All tolerances are ±0.15mm

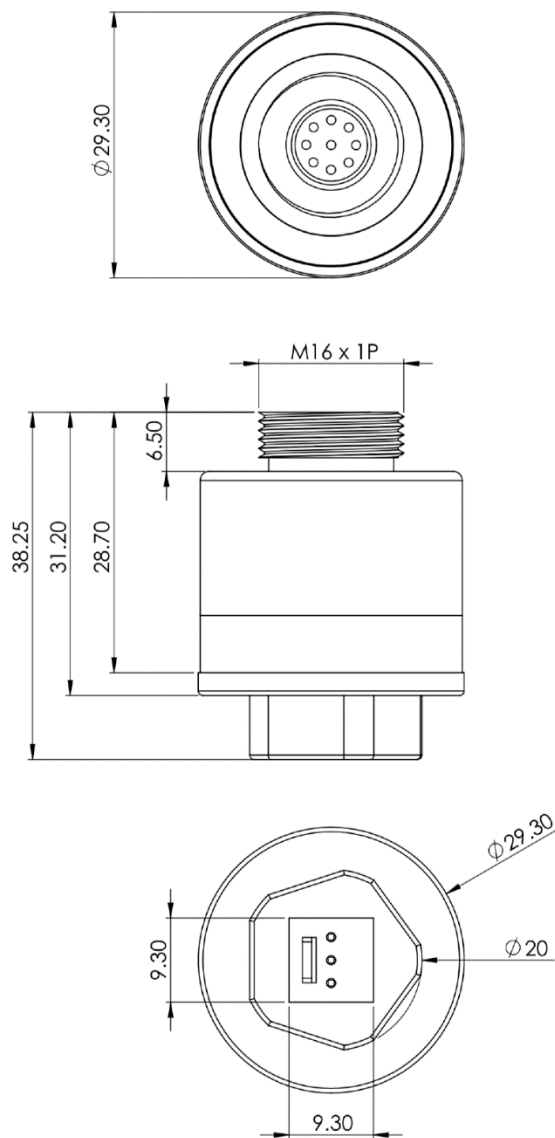

INTRINSIC SAFETY DATA

Max current in normal operation (pure O ₂)	0.01 A
Max o/c Voltage (10 to 100% O ₂)	0.9 V
Max s/c Current (10 to 100% O ₂)	0.5 A

Output (%O₂) vs Temperature

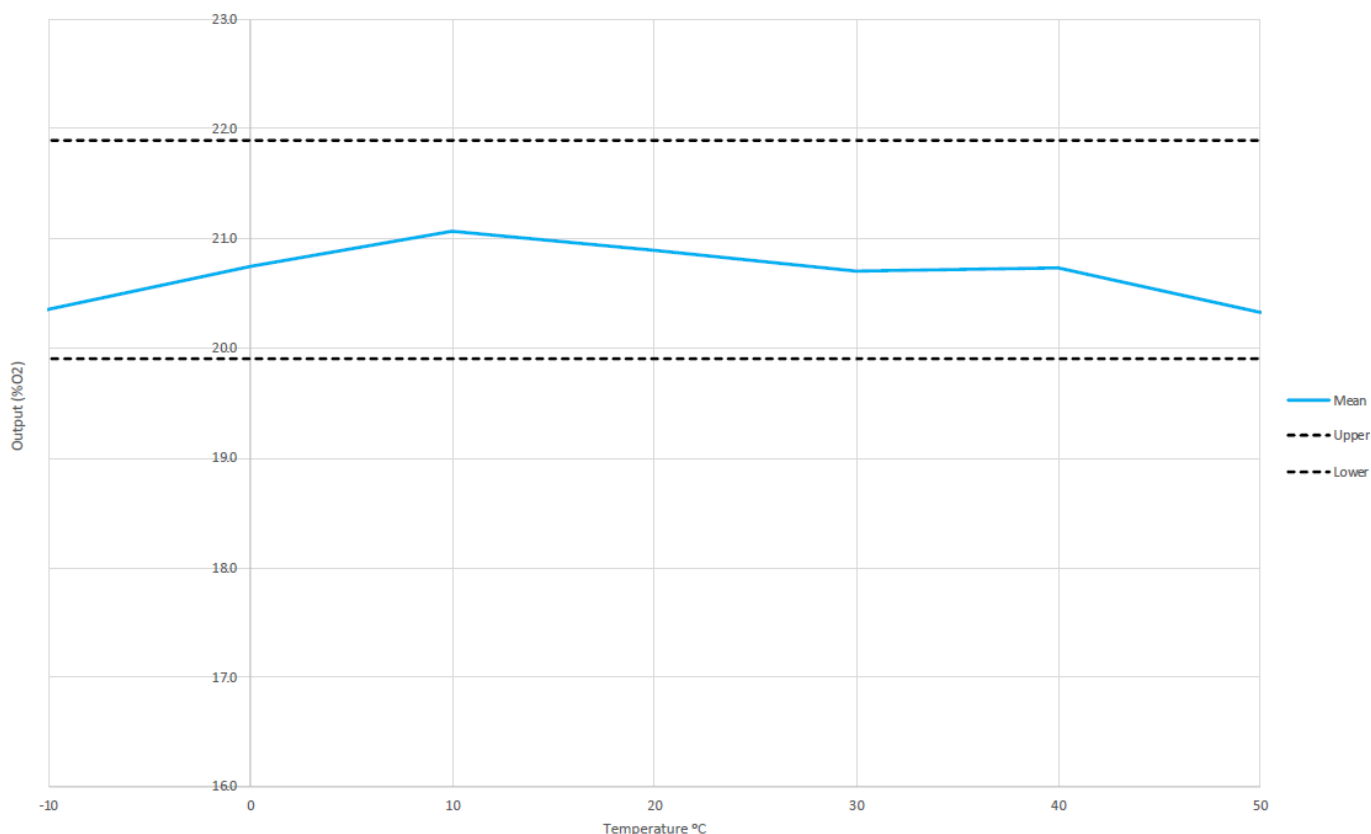

CROSS - SENSITIVITY DATA

Toxic gases at TLV levels will have no cross-sensitivity effect on SGX-VOX oxygen sensors. At very high levels (i.e. % levels), highly oxidising gases (e.g. ozone, chlorine) will interfere to the extent of their oxygen equivalent, but most other commonly occurring gases will have no effect.

ACID GASES



Acid gases such as CO₂ and SO₂ will be absorbed by the electrolyte and tend to increase the flux of oxygen to the electrode. This gives an enhanced oxygen signal of approximately 0.3% of signal per 1% CO₂. SGX-VOX sensor is not suitable for continuous operation in concentrations of CO₂ above 25%. The SGX-VOX sensor is not designed for use in applications where anaesthetic gases are present.

Warning:



By the nature of the technology used, any electrochemical gas sensor offered by SGX Europe Sp. z o.o. can potentially fail to meet specification without warning. SGX Europe Sp. z o.o. makes every effort to ensure the reliability of our products of this type, where life safety is a performance requirement of the product, we recommend that all sensors and instruments using these sensors are checked for response to gas before use. SGX Europe Sp. z o.o. reserves the right to make product changes without notice. No liability is accepted for any consequential losses, injury or damage resulting from the use of this document or from any omissions or errors herein. The data is given for guidance only. It does not constitute a specification or an offer for sale. The products are always subject to a program of improvement and testing which may result in some changes in the characteristics quoted. As the products may be used by the client in circumstances beyond the knowledge and control of SGX Europe Sp. z o.o., we cannot give any warranty as to the relevance of these particulars to an application. It is the clients' responsibility to carry out the necessary tests to determine the usefulness of the products and to ensure their safety of operation in a particular application. Performance characteristics on this data sheet outline the performance of newly supplied sensors. Output signal can drift below the lower limit over.

Looking for pricing, stock, or lifecycle information?

Click below to explore more details on WIN SOURCE:

-  [View SGX-VOX on WIN SOURCE](#)
-  [Amphenol Information](#)

Optimize Your Supply Chain with WIN SOURCE Solutions

-  Global Sourcing Solution
-  Obsolete Management
-  Cost Control Management
-  Shortage Management
-  Alternative Solution
-  Excess Inventory Management