

Signal Relays (2A or less)
TX-S RELAYS

Product Catalog

**IN Your
Future**

TX-S RELAYS

High sensitivity, 50 mW operating power, 2 Form C and 1A relays

Protective construction : Sealed type

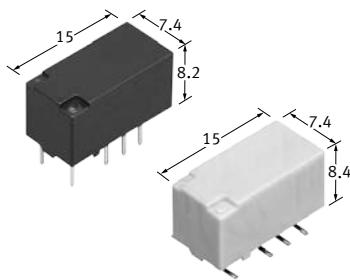

(Unit : mm)

FEATURES

- 2 types of terminal shapes:
PC board terminal and Surface-mount terminal
- Ag+Au clad contact and AgPd contacts suitable for use in low level load analog circuits
- High sensitivity: Rated operating power 50 mW (Single side stable)
- Low thermal electromotive force: Approx. 0.3 μ V
- Compliant with Telcordia standard: Surge withstand voltage 2,500 V (between contact and coil)
- Confort to FCC Part68: Surge withstand voltage 1,500 V (between open contacts)

TYPICAL APPLICATIONS

- Telecommunication equipment and modem
- Medical and security equipment

ORDERING INFORMATION (PART NO. : Ordering part number for Japanese market)

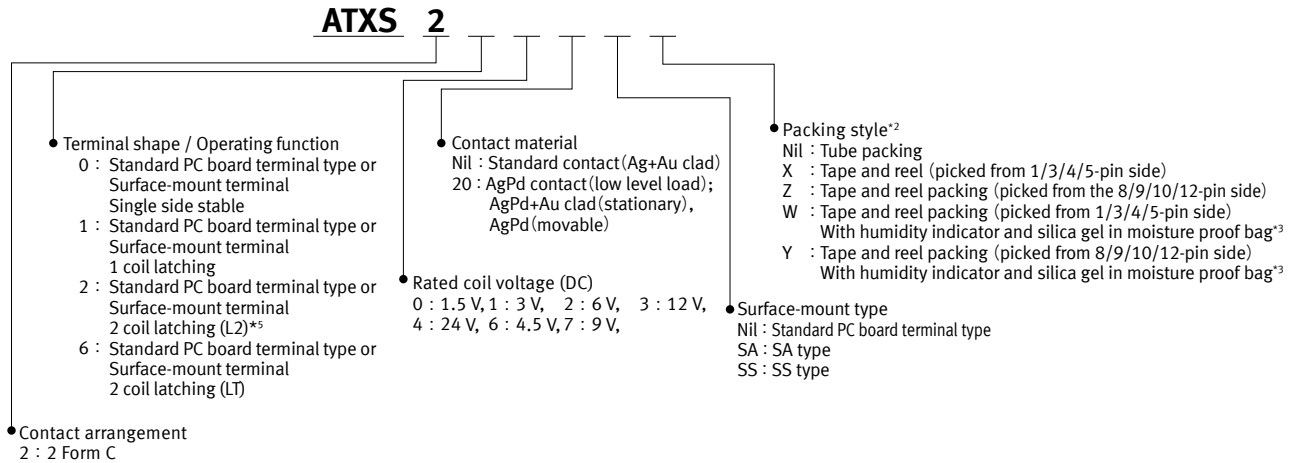

*1: Please contact our sales representative for detailed specifications when using L2 of the operation function.
 *2: The "W" and "Y" at the end of the part number only appears on the inner and outer packing. It does not appear on the relay itself.
 *3: Each reel is packed with humidity indicators and silica gel in the moisture proof pack.

Signal Relays (2A or less) TX-S RELAYS

ORDERING INFORMATION (TYPE NO. : Ordering part number for non Japanese market)

TXS 2 □ - □ - □ - □ - □

● Surface-mount type
Nil : Standard PC board terminal type
SA : SA type
SS : SS type

● Contact arrangement
2 : 2 Form C

● Contact material
Nil : Standard contact (Ag+Au clad)
1 : AgPd contact (low level load);
AgPd+Au clad (stationary),
AgPd (movable)

● Rated coil voltage (DC)
1.5, 3, 4.5, 6, 9, 12, 24 V

● Operating function
Nil : Single side stable
LT : 2 coil latching (SET = 1.6 Pin)*1
L2 : 2 coil latching (SET = 1.12 Pin)

● Packing style*2
Nil : Tube packing
X : Tape and reel (picked from 1/3/4/5-pin side)
Z : Tape and reel packing (picked from the 8/9/10/12-pin side)
W : Tape and reel packing (picked from 1/3/4/5-pin side)
With humidity indicator and silica gel in moisture proof bag*3
Y : Tape and reel packing (picked from 8/9/10/12-pin side)
With humidity indicator and silica gel in moisture proof bag*3

*1: Please contact our sales representative for detailed specifications when using L2 of the operation function.

*2: The "W" and "Y" at the end of the part number only appears on the inner and outer packing.
It does not appear on the relay itself.

*3: Each reel is packed with humidity indicators and silica gel in the moisture proof pack.

TYPES

" Type No. " is ordering part number for non Japanese market. " Part No. " is ordering part number for Japanese market.

■ PC board terminal

● Tube packing

Contact arrangement	Rated coil voltage	Single side stable		2 coil latching (LT)		Standard packing	
		Type No.	Part No.	Type No.	Part No.	Carton (1 Tube packing)	Outer carton
2 Form C	1.5 V DC	TXS2-1.5V	ATXS200	TXS2-LT-1.5V	ATXS260	40 pcs.	1,000 pcs.
	3 V DC	TXS2-3V	ATXS201	TXS2-LT-3V	ATXS261		
	4.5 V DC	TXS2-4.5V	ATXS206	TXS2-LT-4.5V	ATXS266		
	6 V DC	TXS2-6V	ATXS202	TXS2-LT-6V	ATXS262		
	9 V DC	TXS2-9V	ATXS207	TXS2-LT-9V	ATXS267		
	12 V DC	TXS2-12V	ATXS203	TXS2-LT-12V	ATXS263		
	24 V DC	TXS2-24V	ATXS204	TXS2-LT-24V	ATXS264		

Note: Please add "-1" to the end of the type number or "20" to the end of the part number for AgPd contacts (low level load).

■ Surface-mount terminal

● SA Type: Tube packing

Contact arrangement	Rated coil voltage	Single side stable		2 coil latching (LT)		Standard packing	
		Type No.	Part No.	Type No.	Part No.	Carton (1 Tube packing)	Outer carton
2 Form C	1.5 V DC	TXS2SA-1.5V	ATXS200SA	TXS2SA-LT-1.5V	ATXS260SA	40 pcs.	1,000 pcs.
	3 V DC	TXS2SA-3V	ATXS201SA	TXS2SA-LT-3V	ATXS261SA		
	4.5 V DC	TXS2SA-4.5V	ATXS206SA	TXS2SA-LT-4.5V	ATXS266SA		
	6 V DC	TXS2SA-6V	ATXS202SA	TXS2SA-LT-6V	ATXS262SA		
	9 V DC	TXS2SA-9V	ATXS207SA	TXS2SA-LT-9V	ATXS267SA		
	12 V DC	TXS2SA-12V	ATXS203SA	TXS2SA-LT-12V	ATXS263SA		
	24 V DC	TXS2SA-24V	ATXS204SA	TXS2SA-LT-24V	ATXS264SA		

Note: Please add "-1" to the end of the type number or "20" to be added in front of "surface-mount type" in part number for AgPd contacts (low level load).

● SA Type: Tape and reel packing: Z

Contact arrangement	Rated coil voltage	Single side stable		2 coil latching (LT)		Standard packing	
		Type No.	Part No.	Type No.	Part No.	Carton (1 Reel)	Outer carton
2 Form C	1.5 V DC	TXS2SA-1.5V-Z	ATXS200SAZ	TXS2SA-LT-1.5V-Z	ATXS260SAZ	500 pcs.	1,000 pcs.
	3 V DC	TXS2SA-3V-Z	ATXS201SAZ	TXS2SA-LT-3V-Z	ATXS261SAZ		
	4.5 V DC	TXS2SA-4.5V-Z	ATXS206SAZ	TXS2SA-LT-4.5V-Z	ATXS266SAZ		
	6 V DC	TXS2SA-6V-Z	ATXS202SAZ	TXS2SA-LT-6V-Z	ATXS262SAZ		
	9 V DC	TXS2SA-9V-Z	ATXS207SAZ	TXS2SA-LT-9V-Z	ATXS267SAZ		
	12 V DC	TXS2SA-12V-Z	ATXS203SAZ	TXS2SA-LT-12V-Z	ATXS263SAZ		
	24 V DC	TXS2SA-24V-Z	ATXS204SAZ	TXS2SA-LT-24V-Z	ATXS264SAZ		

Notes: 1. Please add "-1" to the end of the type number or "20" to be added in front of "surface-mount type" in part number for AgPd contacts (low level load).

2. For taping packaging X, W, and Y, change "Z" at the end of the part number to "X", "W", and "Y".

RATING

■ Coil data

- Operating characteristics such as "Operate voltage" and "Release voltage" are influenced by mounting conditions or ambient temperature, etc.

Therefore, please use the relay within $\pm 5\%$ of rated coil voltage.

- "Initial" means the condition of products at the time of delivery.

● Single side stable

Rated coil voltage	Operate voltage* (at 20°C)	Release voltage* (at 20°C)	Rated operating current ($\pm 10\%$, at 20°C)	Coil resistance ($\pm 10\%$, at 20°C)	Rated operating power	Max. allowable voltage (at 20°C)
1.5 V DC	Max. 80% V of rated coil voltage (Initial)	Min. 10% V of rated coil voltage (Initial)	33.3 mA	45 Ω	50 mW	150% V of rated coil voltage
3 V DC			16.7 mA	180 Ω		
4.5 V DC			11.1 mA	405 Ω		
6 V DC			8.3 mA	720 Ω		
9 V DC			5.6 mA	1,620 Ω		
12 V DC			4.2 mA	2,880 Ω		
24 V DC			2.9 mA	8,229 Ω	70 mW	

*square, pulse drive

● 2 coil latching

Rated coil voltage	Set voltage* (at 20°C)	Reset voltage* (at 20°C)	Rated operating current ($\pm 10\%$, at 20°C)		Coil resistance ($\pm 10\%$, at 20°C)		Rated operating power		Max. allowable voltage (at 20°C)
			Set coil	Reset coil	Set coil	Reset coil	Set coil	Reset coil	
1.5 V DC	Max. 80% V of rated coil voltage (Initial)	Max. 80% V of rated coil voltage (Initial)	46.7 mA	46.7 mA	32.1 Ω	32.1 Ω	70 mW	70 mW	150% V of rated coil voltage
3 V DC			23.3 mA	23.3 mA	129 Ω	129 Ω			
4.5 V DC			15.6 mA	15.6 mA	289 Ω	289 Ω			
6 V DC			11.7 mA	11.7 mA	514 Ω	514 Ω			
9 V DC			7.8 mA	7.8 mA	1,157 Ω	1,157 Ω			
12 V DC			5.8 mA	5.8 mA	2,057 Ω	2,057 Ω			
24 V DC			6.3 mA	6.3 mA	3,840 Ω	3,840 Ω	150 mW	150 mW	

*square, pulse drive

Signal Relays (2A or less) TX-S RELAYS

■ Specifications

Item	Specifications	
	Standard contact	AgPd contact (low level load)
Contact data	Contact arrangement	2 Form C
	Contact resistance (initial)	Max. 100 mΩ (by voltage drop 6 V DC 1 A)
	Contact material	Ag+Au clad / AgPd+Au clad (stationary), AgPd (movable)
	Contact rating (resistive)	1 A 30 V DC
	Max. switching power (resistive)	30 W (DC)
	Max. switching voltage	110 V DC
	Max. switching current	1 A (DC)
	Min. switching load (reference value)*1	10 μA 10 mV DC
Insulation resistance (initial)	Min. 1,000 MΩ (at 500 V DC, Measured portion is the same as the case of dielectric strength.)	
Dielectric strength (initial)	Between open contacts	750 Vrms for 1 min (detection current: 10 mA)
	Between contact and coil	1,800 Vrms for 1 min (detection current: 10 mA)
	Between contact sets	1,000 Vrms for 1 min (detection current: 10 mA)
Surge withstand voltage (initial)	Between open contacts	1,500 V 10 × 160 μs
	Between contact and coil	2,500 V 2 × 10 μs
Time characteristics (initial)	Operate (Set) time	Max. 5 ms at rated coil voltage (at 20°C, without bounce) [Max. 5 ms (at 20°C, without bounce)]
	Release (Reset) time	Max. 5 ms at rated coil voltage (at 20°C, without bounce, without diode) [Max. 5 ms (at 20°C, without bounce)]
Shock resistance	Functional	750 m/s ² (half-sine shock pulse: 6 ms, detection time: 10 μs)
	Destructive	1,000 m/s ² (half-sine shock pulse: 6 ms)
Vibration resistance	Functional	10 to 55 Hz (at double amplitude of: 3.3 mm, detection time: 10 μs)
	Destructive	10 to 55 Hz (at double amplitude of: 5 mm)
Expected life	Mechanical life	Min. 50 x 10 ⁶ ope. (Switching frequency: at 180 times/min)
Conditions	Conditions for usage, transport and storage*2	Ambient temperature: -40 to +70°C (Allowable temperature is from -40 to +70°C at our standard packing condition.) Humidity: 5 to 85% RH (Avoid icing and condensation)
Unit weight	Approx. 2 g	

Note: For AC load, please inquire our sales office for details.

*1. This value is a rough indication of the lower limit at which switching is possible at micro load level.

This value can change due to the switching frequency, environmental conditions, and desired reliability level, therefore it is recommended to check this with the actual load.
AgPd contact is recommended for low level load (Max. 10 V DC, 10 mA level).

*2. For ambient temperature, please refer to the "GUIDELINES FOR RELAY USAGE".

■ Electrical life

Conditions: resistance load, switching frequency at 20 times / minute.

Type	Switching capacity	Number of operations
2 Form C	Standard contact	Min. 200 x 10 ³ ope.
	AgPd contact (low level load)	Min. 100 x 10 ³ ope.

REFERENCE DATA

1. Max. switching capacity

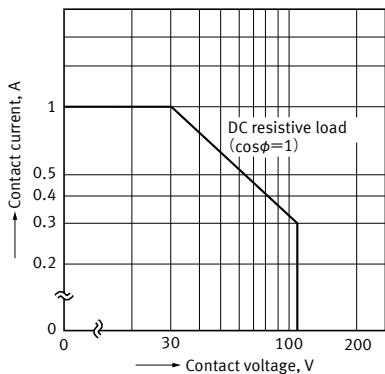

2. Switching life curve

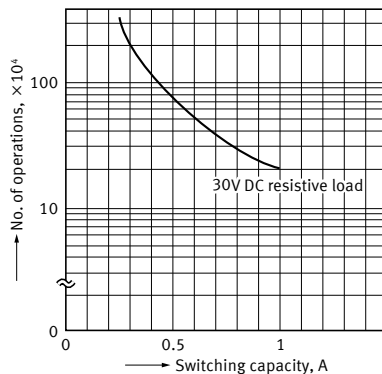

3-1. Coil temperature rise value (Average)

Tested sample : TXS2-4.5V, 6 pcs.
Point measured : Inside the coil
Ambient temperature : 25°C, 70°C

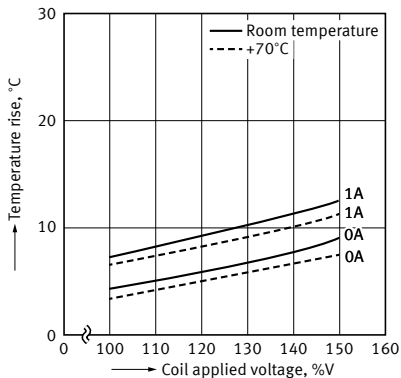

3-2. Coil temperature rise value (Average)

Tested sample : TXS2-24V, 6 pcs.
Point measured : Inside the coil
Ambient temperature : 25°C, 70°C

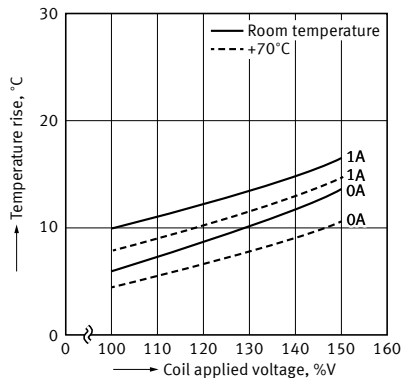

4. Ambient temperature characteristics (Average)

Tested sample : TXS2-4.5V, 5 pcs.

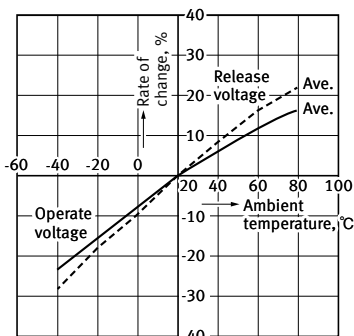

5. Mechanical life

Tested sample : TXS2-4.5V, 10 pcs.
Operating speed : 180 cpm

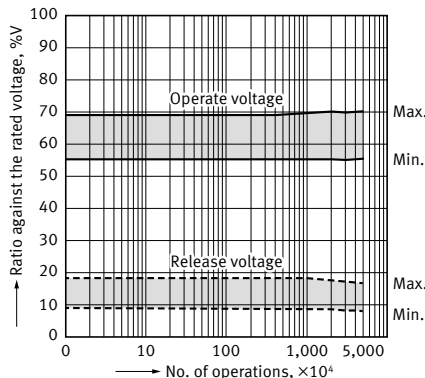

Signal Relays (2A or less) TX-S RELAYS

6. Electrical life test (1 A 30 V DC resistive load)

Tested sample : TXS2-4.5V, 6 pcs.
Operating speed : 20 cpm

Change of operate and release voltage

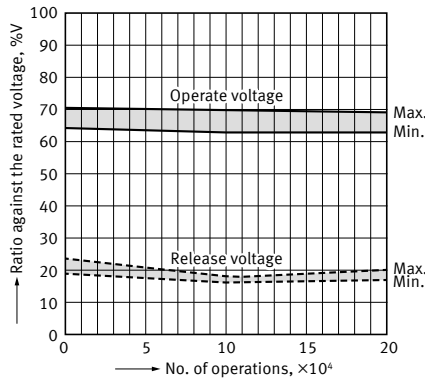

Change of contact resistance

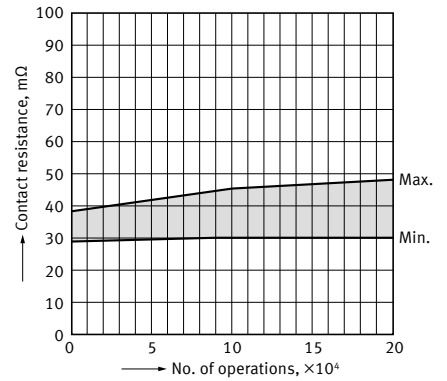

7-1. Operate and release time (without diode)

Tested sample : TXS2-4.5V, 10 pcs.

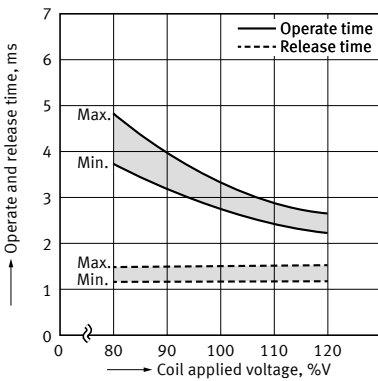

7-2. Operate and release time (with diode)

Tested sample : TXS2-4.5V, 10 pcs.

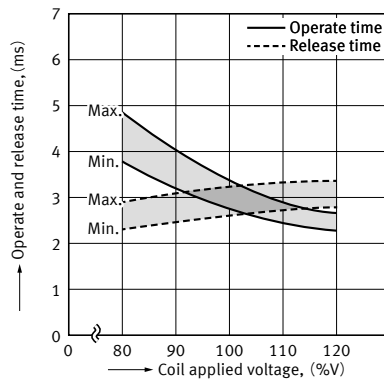

8-1. Functional shock (Single side stable)

Tested sample : TXS2-4.5V, 6 pcs.

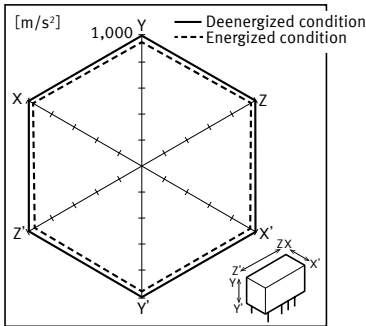

8-2. Functional shock (Latching)

Tested sample : TXS2-LT-4.5V, 6 pcs.

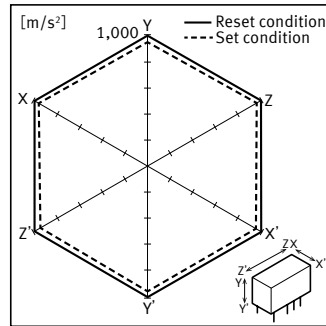

9-1. Influence of proximity mounting

Tested sample : TXS2-4.5V, 6 pcs.

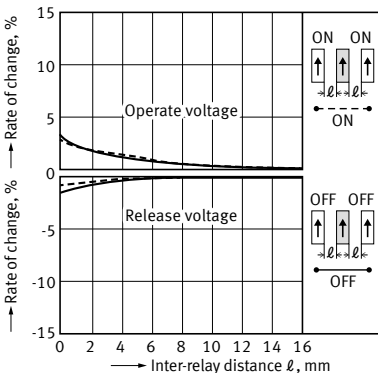

9-2. Influence of proximity mounting

Tested sample : TXS2-4.5V, 6 pcs.

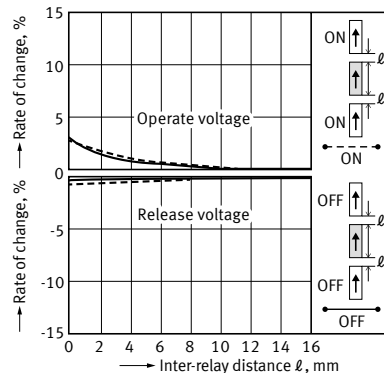

9-3. Influence of proximity mounting

Tested sample : TXS2-4.5V, 6 pcs.

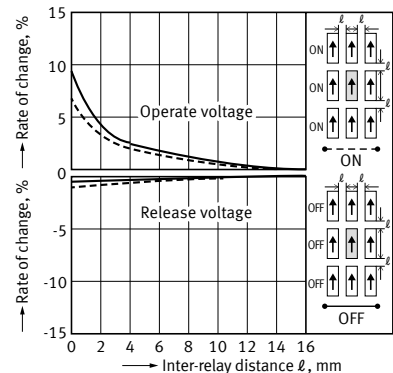

10-1. High frequency characteristics (Isolation)

Tested sample : TXS2-4.5V, 2 pcs.

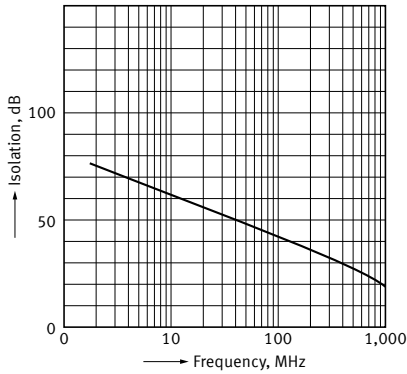

10-2. High frequency characteristics (Insertion loss)

Tested sample : TXS2-4.5V, 2 pcs.

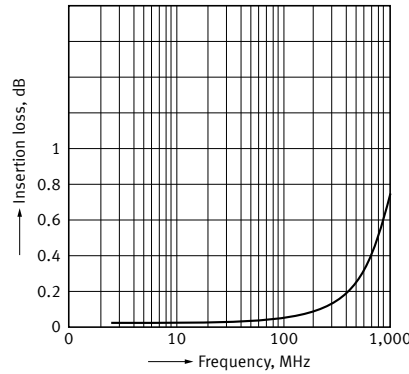

11. Thermal electromotive force

Tested sample : TXS2-4.5V, 10 pcs.

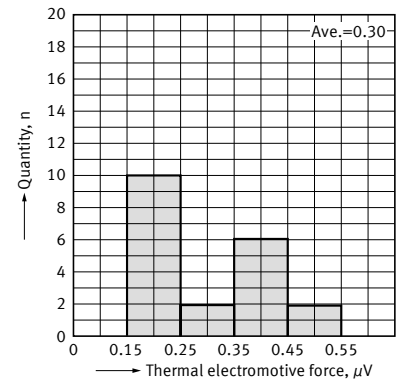

DIMENSIONS

CAD The CAD data of the products with a "CAD" mark can be downloaded from our Website.

Unit: mm

PC board terminal

Single side stable

CAD



External dimensions

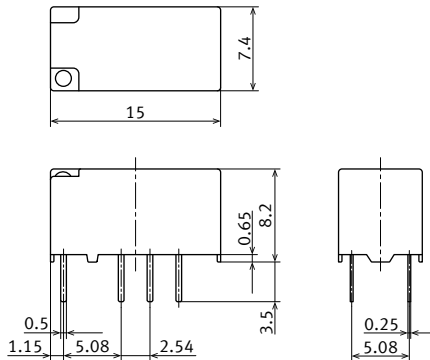

General tolerance : ± 0.3

Recommended PC board pattern (BOTTOM VIEW)

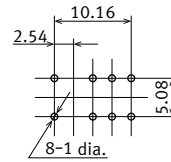

Tolerance : ± 0.1

Schematic (BOTTOM VIEW) (De-energize)

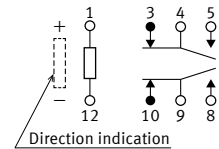

2 coil latching

CAD

External dimensions

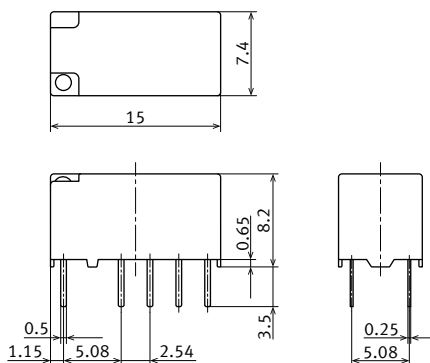

General tolerance : ± 0.3

Recommended PC board pattern (BOTTOM VIEW)

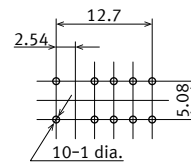

Tolerance : ± 0.1

Schematic (BOTTOM VIEW) (Reset)

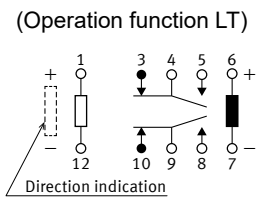

(Operation function L2)

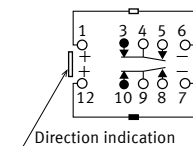

Signal Relays (2A or less) TX-S RELAYS

Surface-mount terminal

CAD



Type	External dimensions	Recommended PC board pattern (TOP VIEW)	Schematic (TOP VIEW)	
SA	Single side stable	<p>General tolerance : ± 0.3</p>	<p>Tolerance : ± 0.1</p>	<p>(De-energize)</p>
	2 coil latching	<p>General tolerance : ± 0.3</p>	<p>Tolerance : ± 0.1</p>	<p>(Reset)</p> <p>(Operation function LT)</p> <p>(Operation function L2)</p>

PACKING STYLE

Unit: mm

Tube packing

- The relay is packing in a tube with the relay orientation mark on the left side, as shown in the figure below.
Be sure to maintain relays in the correct orientation when mounting on PC boards.
- Conditions for operation, transport and storage : -40 to 70°C .

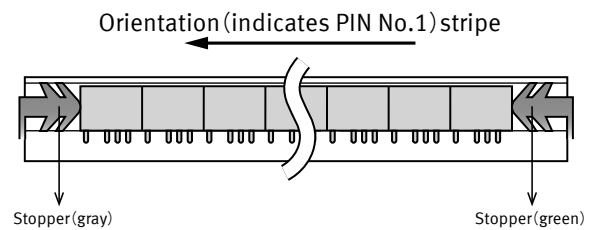

Taping packaging

- Tape dimensions

SA Type

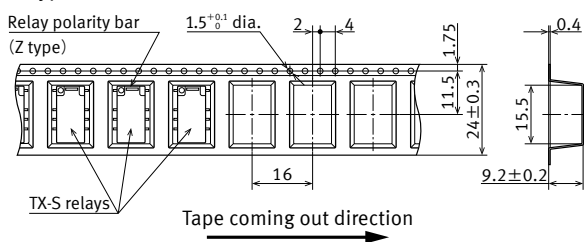

- Dimensions of plastic reel

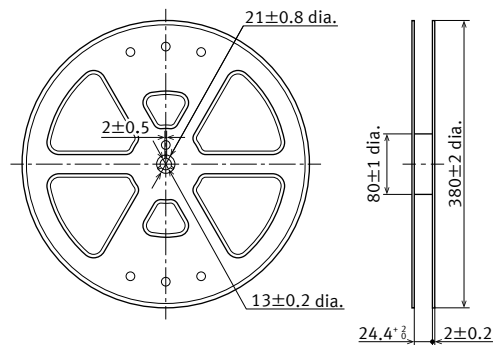

- Conditions for operation, transport and storage : -40 to 70°C .

EXAMPLE OF RECOMMENDED SOLDERING CONDITIONS

■ For cautions for use, please read “Relay Soldering and Cleaning Guidelines” and “SMT Soldering Guidelines”.

■ PC board terminal

In case of hand soldering, the following conditions should be observed.

The effect on the relay depends on the PC board used. Please verify the actual PC board to be used.

● Automatic soldering (Flow)

Recommended conditions	Temperature	Time	Measurement location
Preheating	Max. 120°C	Within 120 seconds	Solder surface terminal
Soldering	260°C ± 5°C	Within 6 seconds	Solder temperature

● Hand soldering

Recommended conditions	Temperature	Time	Measurement location
Soldering	Max. 350°C	Within 3 seconds	Tip temperature

■ Surface-mount terminal

In case of automatic soldering (reflow), the following conditions should be observed.

● IRS (infrared reflow soldering method) heating conditions

Recommend conditions	
Number of reflow	1 time
Measuring position	Surface of PC board where relay is mounted.

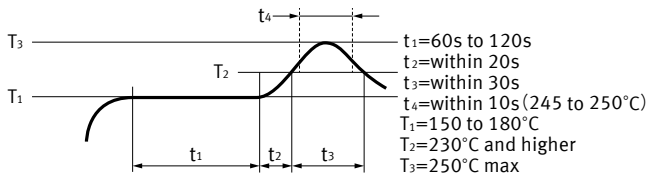
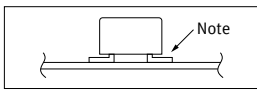
**Measuring position of temperature profile**

Note : The soldering temperature profile indicates the pad temperature. In some cases, the ambient temperature may be greatly increased. Check for the specific mounting condition.

● Mounting cautions

Cautions to observe when mounting temperature increases in the relay are greatly dependent on the way different parts are located a PC board and the heating method of the reflow device. Therefore, please conduct testing on the actual device beforehand after making sure the parts soldered on the relay terminals and the top of the relay case are within the temperature conditions.

■ Other things to observe

- Exceeding the stipulated conditions when soldering may affect coaxial switch performance. Be sure to consult us beforehand.
- Since thermal stress on a relay will depend on the PC board and process conditions, please be sure to test using the actual PC board.
- Creep-up, wettability and solder strength will differ depending on changes in the mounting conditions and type of solder. Please evaluate based on actual production conditions.
- Only apply coating after the relay has returned to room temperature.

SAFETY STANDARDS

Each standard may be updated at any time, so please check our Website for the latest information.

■ UL/C-UL (Approved)

File No.	Contact rating	Operations	Ambient temperature
E43149	1 A 30 V DC Resistive	100 × 10 ³	40°C
	0.5 A 125 V AC Resistive	100 × 10 ³	40°C
	0.3 A 110 V DC Resistive	30 × 10 ³	40°C

■ CSA (Approved)

CSA standard approved by C-UL.

■ BSI (Approved)

BSI standard approved by File No. VC648943 (basic insulation).

GUIDELINES FOR USAGE

■ For cautions for use, please read “GUIDELINES FOR SIGNAL RELAYS USAGE” and “GUIDELINES FOR RELAY USAGE”.

■ Cautions for usage of TX-S relay

● Latching

- Use latching when conditions involve continuous carrying current.
- Regarding the set and reset pulse time, for the purpose of reliable operation under ambient temperature fluctuations and different operating conditions, we recommend setting the coil applied set and reset pulse time to 10 ms or more at the rated coil voltage.
- The relay is shipped in the reset position. But jolts during transport or impacts during installation can change the reset position. It is, therefore, advisable to build a circuit in which the relay can be initialized (set and reset) just after turning on the power.

● External magnetic field

Since TX-S relays are highly sensitive polarized relays, their characteristics will be affected by a strong external magnetic field. Avoid using the relay under that condition.

● Precautions for usage of automatic insertion machine

Set the chucking pressure of the pick-up mechanism by the automatic mounting machine with the pressure shown in table 1 to maintain the internal function of the relay.

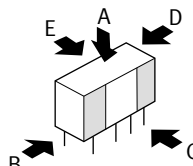

Please chuck the  portion. Avoid chucking the center of the relay. In addition, excessive chucking pressure to the pinpoint of the relay should be also avoided.

Table 1: Chucking pressure

A, B and D direction	Max. 9.8 N (1 kgf)
C and E direction	Max. 4.9 N (500 gf)

GUIDELINES FOR SIGNAL RELAYS USAGE

■ For cautions for use, please read "GUIDELINES FOR RELAY USAGE".

https://industrial.panasonic.com/ac/e/control/relay/cautions_use/index.jsp

PRECAUTIONS FOR COIL INPUT

■ Long term current carrying

A circuit that will be carrying a current continuously for long periods without relay switching operation. (circuits for emergency lamps, alarm devices and error inspection that, for example, revert only during malfunction and output warnings with form B contacts)

Continuous, long-term current to the coil will facilitate deterioration of coil insulation and characteristics due to heating of the coil itself. For circuits such as these, please use a magnetic-hold type latching relay. If you need to use a single stable relay, use a sealed type relay that is not easily affected by ambient conditions and make a failsafe circuit design that considers the possibility of contact failure or disconnection.

■ DC Coil operating power

Steady state DC current should be applied to the coil.

The wave form should be rectangular. If it includes ripple, the ripple factor should be less than 5%. However, please check with the actual circuit since the electrical characteristics may vary.

The rated coil voltage should be applied to the coil and the set/reset pulse time of latching type relay differs for each relays, please refer to the relay's individual specifications.

■ Coil connection

When connecting coils of polarized relays, please check coil polarity(+,-) at the internal connection diagram (Schematic).

If any wrong connection is made, it may cause unexpected malfunction, like abnormal heat, fire and so on, and circuit do not work.

Avoid impressing voltages to the set coil and reset coil at the same time.

■ Maximum allowable voltage and temperature rise

Proper usage requires that the rated coil voltage be impressed on the coil.

Note, however, that if a voltage greater than or equal to the maximum continuous voltage is impressed on the coil, the coil may burn or its layers short due to the temperature rise.

Furthermore, do not exceed the usable ambient temperature range listed in the catalog.

● Operate voltage change due to coil temperature rise (hot start)

In DC relays, after continuous passage of current in the coil, if the current is turned OFF, then immediately turned ON again, due to the temperature rise in the coil, the operate voltage will become somewhat higher. Also, it will be the same as using it in a higher temperature atmosphere.

The resistance/temperature relationship for copper wire is about 0.4% for 1°C, and with this ratio the coil resistance increases.

That is, in order to operate of the relay, it is necessary that the voltage be higher than the operate voltage and the operate voltage rises in accordance with the increase in the resistance value.

However, for some polarized relays, this rate of change is considerably smaller.

NOTES

■ Usage, Storage, and Transport Conditions

During usage, storage, or transportation, avoid locations subject to direct sunlight and maintain normal temperature, humidity, and pressure conditions.

The allowable specifications for environments suitable for usage, storage, and transportation are given below.

1) Temperature: The allowable temperature range differs for each relay, so refer to the relay's individual specifications. In addition, when transporting or storing relays while they are tube packaged, there are cases when the temperature may differ from the allowable range. In this situation, be sure to consult the individual specifications.

2) Humidity: 5 to 85% RH

The humidity range varies with the temperature.
Use within the range indicated in the graph.
(The allowable temperature depends on the relays.)

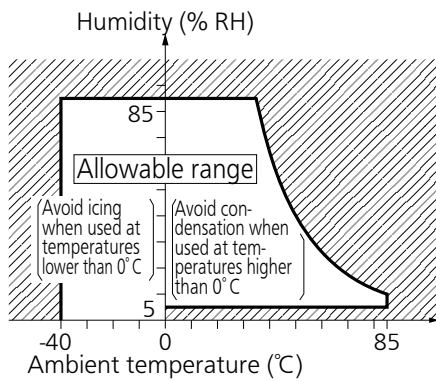

3) Pressure: 86 to 106 kPa

● Condensation

Condensation occurs when the ambient temperature drops suddenly from a high temperature and humidity, or the relay and microwave device is suddenly transferred from a low ambient temperature to a high temperature and humidity.

Condensation causes the failures like insulation deterioration, wire disconnection and rust etc.

Panasonic Industry Co., Ltd. does not guarantee the failures caused by condensation.

The heat conduction by the equipment may accelerate the cooling of device itself, and the condensation may occur.

Please conduct product evaluations in the worst condition of the actual usage. (Special attention should be paid when high temperature heating parts are close to the device. Also please consider the condensation may occur inside of the device.)

● Icing

Condensation or other moisture may freeze on relays when the temperature become lower than 0°C.

This icing causes the sticking of movable portion, the operation delay and the contact conduction failure etc.

Panasonic Industry Co., Ltd. does not guarantee the failures caused by the icing.

The heat conduction by the equipment may accelerate the cooling of relay itself and the icing may occur.

Please conduct product evaluations in the worst condition of the actual usage.

● Low temperature and low humidity

The plastic becomes brittle if the switch is exposed to a low temperature, low humidity environment for long periods of time.

● High temperature and high humidity

Storage for extended periods of time (including transportation periods) at high temperature or high humidity levels or in atmospheres with organic gases or sulfide gases may cause a sulfide film or oxide film to form on the surfaces of the contacts and/or it may interfere with the functions.

Check out the atmosphere in which the units are to be stored and transported.

● Package

In terms of the packing format used, make every effort to keep the effects of moisture, organic gases and sulfide gases to the absolute minimum.

GUIDELINES FOR SIGNAL RELAYS USAGE

● Storage requirements

Since the surface-mount terminal type is sensitive to humidity it is packaged with tightly sealed anti-humidity packaging. However, when storing, please be careful of the following.

- 1) Please use promptly once the anti-humidity pack is opened. (within 72 hours, Max. 30°C / 70% RH).
If left with the pack open, the relay will absorb moisture which will cause thermal stress when reflow mounting and thus cause the case to expand. As a result, the seal may break.
- 2) If relays will not be used within 72 hours, please store relays in a humidity controlled desiccator or in an anti-humidity bag to which silica gel has been added.

* If the relay is to be soldered after it has been exposed to excessive humidity atmosphere, cracks and leaks can occur.
Be sure to mount the relay under the required mounting conditions.

- 3) When relays (which is packaged with humidity indicator and silica gel) meeting one of below criteria, please bake (dry) before use.
 - When the storage conditions specified in 1) are exceeded.
 - When humidity indicator is in III or IV status according to judgement standard.

<How to judge>

Please check humidity indicator color and decide if baking is necessary or not.

● : indicate brown, ○ : Other than brown (blueish color)

	5%	10%	60%	Bake treatment necessity judgment
I	●	●	●	No need to bake
II	○	●	●	No need to bake
III	○	○	●	Need to bake
IV	○	○	○	Need to bake

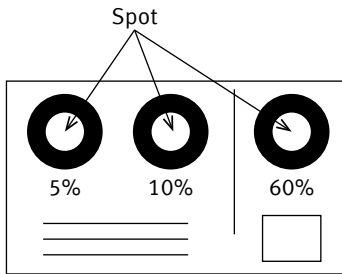

Humidity indicator card

<Baking (Drying) conditions>

- With reel : 45°C, 96 hours or more.

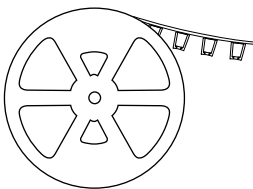

- Without reel (including relay only) : 60°C, 35 hours or more.

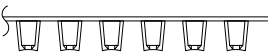

- 4) The following cautionary label is affixed to the anti-humidity pack.

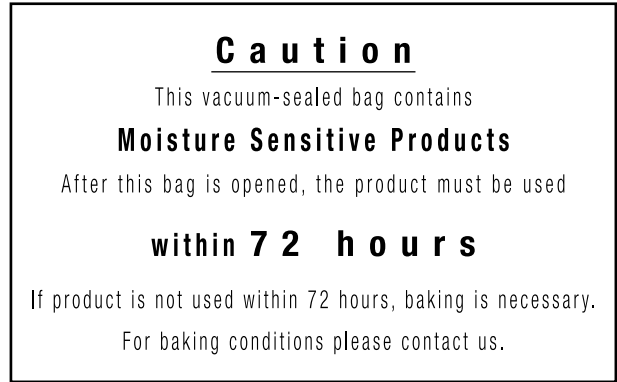

● Silicon

When a source of silicone substances (silicone rubber, silicone oil, silicone coating materials and silicone filling materials etc.) is used around the relay, the silicone gas (low molecular siloxane etc.) may be produced

This silicone gas may penetrate into the inside of the relay. When the relay is kept and used in this condition, silicone compound may adhere to the relay contacts which may cause the contact failure.

Do not use any sources of silicone gas around the relay (Including plastic seal types).

● NOx Generation

When relay is used in an atmosphere high in humidity to switch a load which easily produces an arc, the NOx created by the arc and the water absorbed from outside the relay combine to produce nitric acid.

This corrodes the internal metal parts and adversely affects operation.

Avoid use at an ambient humidity of 85% RH or higher (at 20°C).

If use at high humidity is unavoidable, please contact our sales representative.

OTHERS

■Cleaning

- 1) Although the environmentally sealed type relay (plastic sealed type, etc.) can be cleaned, avoid immersing the relay into cold liquid (such as cleaning solvent) immediately after soldering. Doing so may deteriorate the sealing performance.
- 2) Surface-mount terminal type relay is sealed type and it can be cleaned by immersion.
Use pure water or alcohol-based cleaning solvent.
- 3) Cleaning with the boiling method is recommended (The temperature of cleaning liquid should be 40°C or lower). Avoid ultrasonic cleaning on relays.
Use of ultrasonic cleaning may cause breaks in the coil or slight sticking of the contacts due to the ultrasonic energy.

Please refer to **"the latest product specifications"** when designing your product.

•Requests to customers:

<https://industrial.panasonic.com/ac/e/salespolicies/>



Panasonic
INDUSTRY

Panasonic Industry Co., Ltd.

Electromechanical Control Business Division
■1006, Oaza Kadoma, Kadoma-shi, Osaka 571-8506, Japan
industrial.panasonic.com/ac/e/

Looking for pricing, stock, or lifecycle information?

Click below to explore more details on WIN SOURCE:

-  [View TXS2-L2-3V on WIN SOURCE](#)
-  [Panasonic Information](#)

Optimize Your Supply Chain with WIN SOURCE Solutions

-  Global Sourcing Solution
-  Obsolete Management
-  Cost Control Management
-  Shortage Management
-  Alternative Solution
-  Excess Inventory Management