



**THE DATASHEET OF
ASPI-4030S-2R2N-T**



Wire Wound Magnetically Shielded SMD Power Inductor



4.0 x 4.0 x 3.0 mm

ASPI-4030S



RoHS/RoHS II Compliant

FEATURES:

- Shielded magnetics, low radiation
- Large Terminal surface for good PCB bonding
- Low DCR, High Energy storage, suitable for large currents
- Ideal for a variety of DC-DC converter inductor applications

APPLICATIONS:

- Portable communication equipment
- OA equipment
- LCD, DVD, modem, set-top box
- DC/DC converters

ELECTRICAL SPECIFICATIONS:

Abracon P/N:	ASPI-4030S Series
Operating Temperature :	-40°C to +125°C
Storage Temperature :	-10°C to +40°C and 70% R.H. max

Part Number	Inductance	L Tolerance	DC Resistance (±30%)	Saturation Current	Temperature Rise Current	Self resonant frequency	Inductance Code Marking
Units	μH	—	Ω	A Max	A Max	MHz Min	
Symbol	L	N, M	DCR	Isat	Irms	SRF	
ASPI-4030S-R91	0.91	N	0.013	6.25	4.15	100	R91
ASPI-4030S-1R0	1.0	N	0.014	5.26	4.15	70	1R0
ASPI-4030S-1R2	1.2	N	0.015	5.80	3.82	80	1R2
ASPI-4030S-1R5	1.5	N	0.020	4.84	3.34	62	1R5
ASPI-4030S-1R8	1.8	N	0.025	5.40	3.20	60	1R8
ASPI-4030S-2R2	2.2	N	0.030	4.90	2.95	52	2R2
ASPI-4030S-3R3	3.3	M	0.040	3.30	2.40	38	3R3
ASPI-4030S-4R3	4.3	M	0.055	2.95	2.10	37	4R3
ASPI-4030S-4R7	4.7	M	0.060	2.90	2.00	31	4R7
ASPI-4030S-5R6	5.6	M	0.065	2.60	1.95	30	5R6
ASPI-4030S-6R8	6.8	M	0.090	2.75	1.60	24	6R8
ASPI-4030S-7R5	7.5	M	0.085	2.20	1.65	26	7R5
ASPI-4030S-8R2	8.2	M	0.090	2.10	1.60	26	8R2
ASPI-4030S-100	10	M	0.100	1.95	1.50	21	100
ASPI-4030S-120	12	M	0.135	1.70	1.30	18	120
ASPI-4030S-150	15	M	0.190	1.65	1.11	16	150
ASPI-4030S-180	18	M	0.200	1.40	1.10	10	180
ASPI-4030S-220	22	M	0.225	1.30	1.00	10	220
ASPI-4030S-330	33	M	0.330	1.10	0.84	10	330
ASPI-4030S-360	36	M	0.335	1.05	0.83	9.8	360
ASPI-4030S-390	39	M	0.435	1.03	0.73	10	390
ASPI-4030S-470	47	M	0.445	0.95	0.72	8.4	470
ASPI-4030S-510	51	M	0.470	0.90	0.70	8.4	510
ASPI-4030S-560	56	M	0.555	0.85	0.65	8.4	560
ASPI-4030S-620	62	M	0.585	0.80	0.63	7.0	620
ASPI-4030S-680	68	M	0.868	0.72	0.52	7.0	680
ASPI-4030S-750	75	M	1.020	0.70	0.48	6.3	750
ASPI-4030S-820	82	M	1.060	0.66	0.47	5.6	820
ASPI-4030S-910	91	M	1.100	0.65	0.46	5.6	910
ASPI-4030S-101	100	M	1.150	0.60	0.45	5.6	101
ASPI-4030S-121	120	M	1.350	0.55	0.42	5.4	121

Test Conditions:

- Ambient Temperature: 20±15°C
- Relative Humidity: 65%±20%
- Air Pressure: 86KPa to 106KPa

Inductance (L): WK3260B LCR meter or equivalent, 100kHz, 1Vrms

Direct Current Resistance (DCR): HIOKI 3540 or equivalent

Saturation Current (Isat): WK3260B LCR meter or equivalent

Isat: Based on inductance change ($\Delta L/L_0$: ≤-30%)

Temperature rise current (Irms): Electric Power, Electric current meter, Thermometer

Irms: Based on temperature rise (ΔT : 40°C TYP.)

ABRACON IS
ISO9001:2008
CERTIFIED



ABRACON
CORPORATION

Visit www.abracon.com for Terms & Conditions of Sale

30332 Esperanza, Rancho Santa Margarita, California 92688
tel 949-546-8000 | fax 949-546-8001 | www.abracon.com

Revised: 03.09.13

Wire Wound Magnetically Shielded SMD Power Inductor



4.0 x 4.0 x 3.0 mm

ASPI-4030S

Pb | RoHS/RoHS II Compliant

ELECTRICAL CHARACTERISTICS CURVES

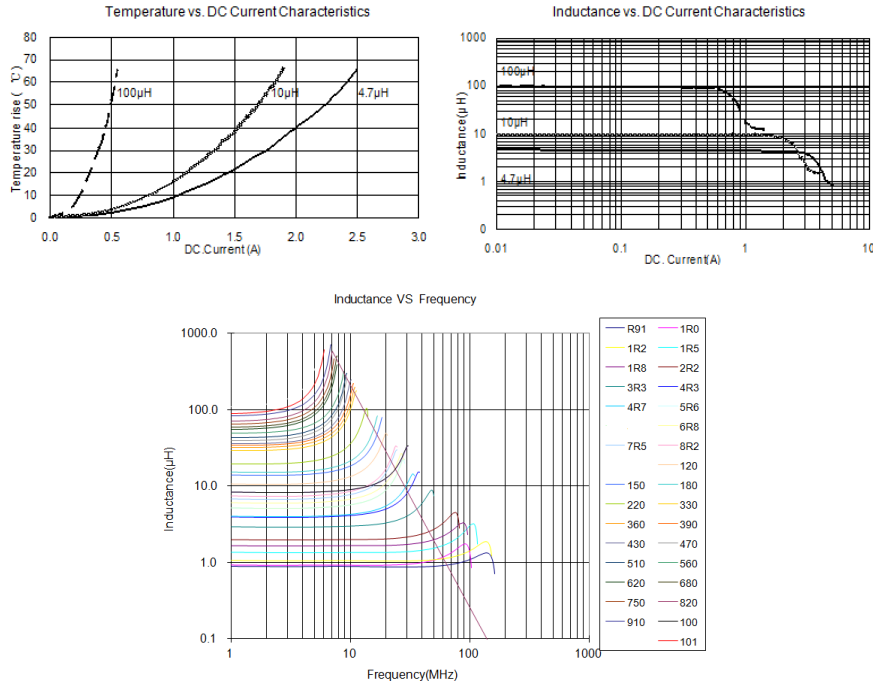

PART IDENTIFICATION:

ASPI-4030S - [] - []

Inductance Code
Please refer to the table above

Tolerance
M: ±20% *
N: ±30% *

Packaging
T: Tape and Reel
(2kpcs / reel)

*M for 3.3µH~120µH
*N for 0.91µH~2.2µH

OUTLINE DIMENSIONS:

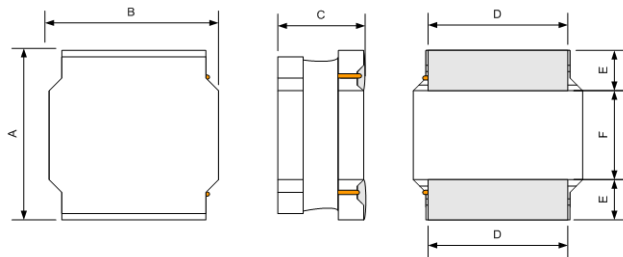

Recommended Land Pattern

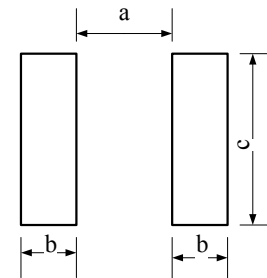

A	B	C Max.	D	E	F	a Typ.	b Typ.	c Typ.
4.0±0.2	4.0±0.2	3.0	3.3±0.2	0.95±0.2	2.1±0.2	1.9	1.1	3.4

Dimensions: mm

ABRACON IS
ISO9001:2008
CERTIFIED



Visit www.abracon.com for Terms & Conditions of Sale
30332 Esperanza, Rancho Santa Margarita, California 92688
tel 949-546-8000 | fax 949-546-8001 | www.abracon.com

Revised: 03.09.13

Wire Wound Magnetically Shielded SMD Power Inductor



4.0 x 4.0 x 3.0 mm

ASPI-4030S

Pb | RoHS/RoHS II Compliant

Materials

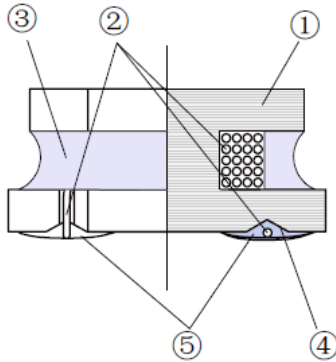

No	Components	Material
1	Ferrite Core	Ni-Zn Ferrite
2	Wire	Polyurethane System enameled copper wire
3	Magnetic Glue	Epoxy resin and magnetic powder
4	Plating Electrodes	Plating: Ag/Ni/Sn
5	Outer Electrodes	Top surface solder coating: Sn96.5%/Ag3%/Cu0.5%

REFLOW PROFILE:

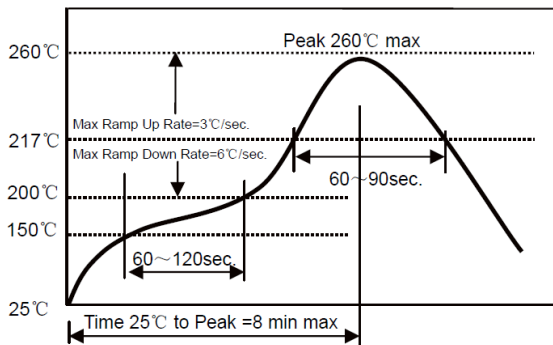

- Δ Preheat condition: 150 ~200°C /60~120sec.
- Δ Allowed time above 217°C: 60~90sec.
- Δ Max temp: 260°C
- Δ Max time at max temp: 5sec.
- Δ Solder paste: Sn/3.0Ag/0.5Cu
- Δ Allowed Reflow time: 2x max

TAPE & REEL:

T: 2,000pcs / reel

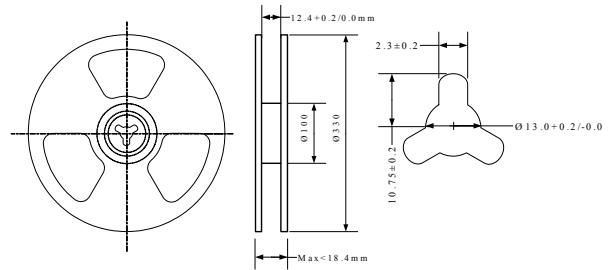
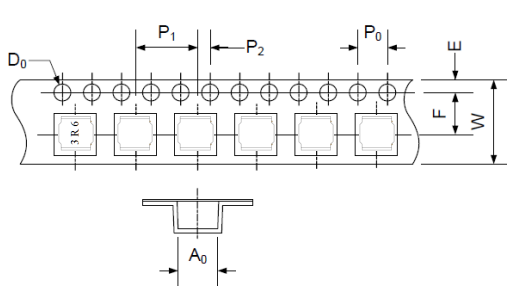

A0	B0	W	E	F	P0	P1	P2	D0	T	K
4.3±0.1	4.3±0.1	12.0±0.3	1.75±0.1	5.5±0.1	4.0±0.1	8.0±0.1	2.0±0.1	1.5+0.1/-0.0	0.4±0.03	3.2±0.1

Storage Conditions

- a. To maintain the solderability of terminal electrodes and to keep the packing material in good condition, temperature and humidity in the storage area should be controlled.
- b. Recommended conditions: -10°C ~ +40 °C, 70% RH (Max.)
- c. Even under ideal storage conditions, solderability of products electrodes may decrease as time passes. For this reason, product should be used with one year from the time of delivery.
- d. In case of storage over 12 months, solderability shall be checked before actual usage.

Dimensions: mm

ATTENTION: Abracon Corporation's products are COTS – Commercial-Off-The-Shelf products; suitable for Commercial, Industrial and, where designated, Automotive Applications. Abracon's products are not specifically designed for Military, Aviation, Aerospace, Life-dependant Medical applications or any application requiring high reliability where component failure could result in loss of life and/or property. For applications requiring high reliability and/or presenting an extreme operating environment, written consent and authorization from Abracon Corporation is required. Please contact Abracon Corporation for more information.

ABRACON IS
ISO9001:2008
CERTIFIED



Visit www.abracon.com for Terms & Conditions of Sale **Revised: 03.09.13**
30332 Esperanza, Rancho Santa Margarita, California 92688
tel 949-546-8000 | fax 949-546-8001 | www.abracon.com

Looking for pricing, stock, or lifecycle information?

Click below to explore more details on WIN SOURCE:

 [View ASPI-4030S-2R2N-T on WIN SOURCE](#)

 [Abracon LLC Information](#)

Optimize Your Supply Chain with WIN SOURCE Solutions

-  Global Sourcing Solution
-  Obsolete Management
-  Cost Control Management
-  Shortage Management
-  Alternative Solution
-  Excess Inventory Management