



**THE DATASHEET OF  
JTR1024S05**



### 10 Watts

- Regulated single outputs from 3.3 to 30VDC, dual outputs  $\pm 12$  &  $\pm 15$ VDC
- Wide 4:1 DC input range 9 to 36 or 18 to 75VDC
- DIP16 metal case
- Output voltage trim  $\pm 10\%$  (single output models)
- High efficiency up to 87%
- IEC/UL/cUL 62368-1 safety approvals (pending)
- Complies with EN55032 class A with no external components
- $-40^{\circ}\text{C}$  to  $+85^{\circ}\text{C}$  operating temperature
- Full power to  $+70^{\circ}\text{C}$
- MTBF >500 khrs (MIL-HDBK-217F,  $+25^{\circ}\text{C}$  GB)
- 3 year warranty

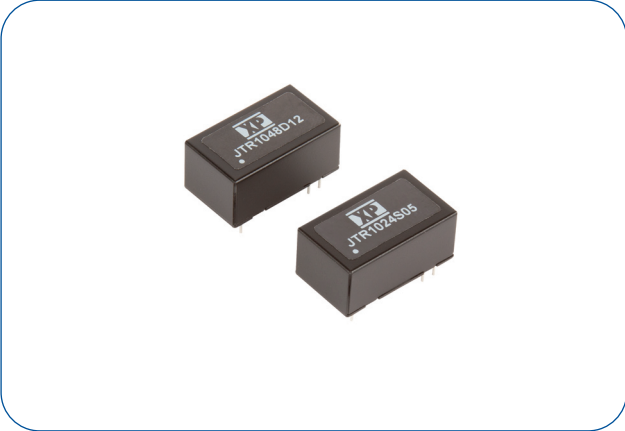

#### Dimensions:

**JTR10:**  
0.94 x 0.54 x 0.41" (23.8 x 13.7 x 10.3 mm)

### Models & Ratings

Input voltage	Output voltage	Output current (full load)	Input current <sup>(1)</sup>		Max. Capacitive Load	Efficiency	Model number
			No load	Full load			
24V (9-36V)	3.3 V	2700 mA	10 mA	464 mA	2600 $\mu\text{F}$	80%	JTR1024S3V3
	5.0 V	2000 mA		502 mA	1300 $\mu\text{F}$	83%	JTR1024S05
	12.0 V	833 mA		479 mA	560 $\mu\text{F}$	87%	JTR1024S12
	15.0 V	666 mA		479 mA	560 $\mu\text{F}$	87%	JTR1024S15
	24.0 V	416 mA		479 mA	330 $\mu\text{F}$	87%	JTR1024S24
	$\pm 12.0$ V	$\pm 416$ mA		478 mA	$\pm 390$ $\mu\text{F}$	87%	JTR1024D12
	$\pm 15.0$ V	$\pm 333$ mA		478 mA	$\pm 220$ $\mu\text{F}$	87%	JTR1024D15
	48V (18-75V)	3.3 V		2700 mA	7 mA	232 mA	2600 $\mu\text{F}$
5.0 V	2000 mA	251 mA	1300 $\mu\text{F}$	83%		JTR1048S05	
12.0 V	833 mA	239 mA	560 $\mu\text{F}$	87%		JTR1048S12	
15.0 V	666 mA	239 mA	560 $\mu\text{F}$	88%		JTR1048S15	
24.0 V	416 mA	239 mA	330 $\mu\text{F}$	87%		JTR1048S24	
$\pm 12.0$ V	$\pm 416$ mA	239 mA	$\pm 390$ $\mu\text{F}$	87%		JTR1048D12	
$\pm 15.0$ V	$\pm 333$ mA	239 mA	$\pm 220$ $\mu\text{F}$	87%		JTR1048D15	

1. Input currents measured at nominal input voltage.

2. Standard tube quantity: 20

### Mechanical Details

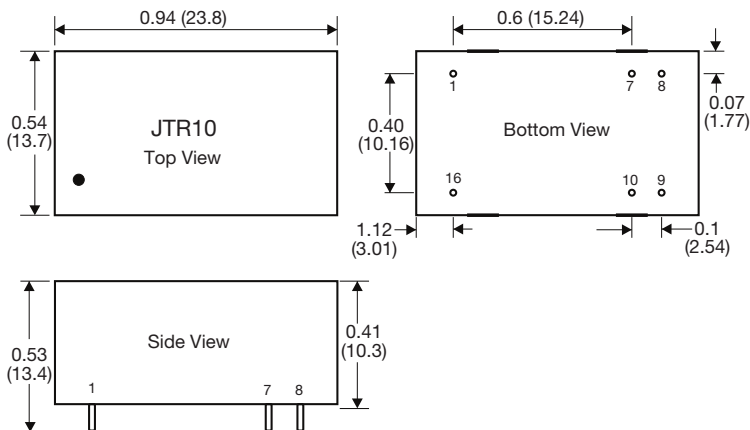

Pin Connections		
Pin	Single	Dual
1	-Vin	-Vin
7	Trim	No Connection
8	No Connection	Common
9	+Vout	+Vout
10	-Vout	-Vout
16	+Vin	+Vin

#### Notes

1. All dimensions are in inches (mm)
2. Weight: 0.0022 lbs (10 g) approx.
3. Tolerance: X.XX $\pm$ 0.01 (X.X $\pm$ 0.25), X.XXX $\pm$ 0.005 (X.XX $\pm$ 0.13)

4. Pin Diameter: 0.02 (0.5)
5. Pin Tolerance:  $\pm 0.002$  ( $\pm 0.05$ )

### Input

Characteristic	Minimum	Typical	Maximum	Units	Notes & Conditions
Input Voltage Range	9.0		36	VDC	24 V nominal
	18.0		75	VDC	48 V nominal
Input Filter	Internal Pi type				
Undervoltage Lockout	ON at 8.8 V, OFF at 7.0 V				24 V models
	ON at 17.8 V, OFF at 16.0 V				48 V models
Input Surge			50	VDC	24 V models for 100 ms max
			100		48 V models for 100 ms max

### Output

Characteristic	Minimum	Typical	Maximum	Units	Notes & Conditions
Output Voltage	3.3		30	VDC	See Models and Ratings table
Initial Set Accuracy			±1.0	%	At full load
Output Voltage Balance			±1.0	%	For dual output with balanced loads
Minimum Load					No minimum load required
Line Regulation			±0.5	%	From minimum to maximum input at full load
Load Regulation			±1.0	%	From 0 to full load
Cross Regulation			±5.0	%	On dual output models when one load is varied between 25% and 100% and other is fixed at 100%
Transient Response		3	5	% deviation	Recovery within 1% in less than 250 µs for a 25% load change.
Ripple & Noise			60	mV pk-pk	3V3, 5 V output models: 20 MHz bandwidth. Measured using 1 µF ceramic capacitor and 10 µF electrolytic capacitor
			80		Other models: 20 MHz bandwidth. Measured using 1 µF ceramic capacitor and 10 µF electrolytic capacitor
Overload Protection		160		%	
Short Circuit Protection					Continuous Trip & Restart (Hiccup mode), with auto recovery
Maximum Capacitive Load					See Models and Ratings table
Temperature Coefficient			0.02	%/°C	

### General

Characteristic	Minimum	Typical	Maximum	Units	Notes & Conditions
Efficiency		87		%	See Models and Ratings table
Isolation: Input to Output	1500			VDC	60 s functional
Isolation Resistance	10 <sup>9</sup>			Ω	At 500 VDC
Isolation Capacitance		1500		pF	
Switching Frequency		370		kHz	
Case Material	Black coated copper with non conductive plastic base UL94V-0 rated				
Potting Material	Epoxy UL94V-0				
Pin Material	Brass, solder coated				
Solder Profile	260 °C max. 1.5mm from case 10s maximum.				
Water Wash	Use deionized water, do not soak. Dry thoroughly.				
Power Density			48	W/in <sup>3</sup>	
Mean Time Between Failure	500			KHrs	MIL-HDBK-217F, +25 °C GB
Weight		0.0022 (10)		lb (g)	

### Environmental

Characteristic	Minimum	Typical	Maximum	Units	Notes & Conditions
Operating Temperature	-40		+85	°C	See Derating Curve
Storage Temperature	-55		+125	°C	
Case Temperature			+105	°C	
Humidity			95	%RH	Non-condensing
Cooling	Natural convection				

### Safety Approvals

Safety Agency	Safety Standard	Notes & Conditions
UL	UL/cUL62368-1	Information Technology.
CE	Meets all applicable directives	
UKCA	Meets all applicable legislation	

### EMC: Emissions

Phenomenon	Standard	Test Level	Notes & Conditions
Conducted & Radiated	EN55032	Class A	No external components required. See application notes for Class B.

### EMC: Immunity

Phenomenon	Standard	Test Level	Criteria	Notes & Conditions
ESD	EN61000-4-2	±8 kV air discharge, ±6 kV contact	A	
Radiated	EN61000-4-3	20 V/m	A	
EFT/Burst	EN61000-4-4	±2 kV	A	With external capacitor and TVS. See applications notes.
Surge	EN61000-4-5	±1 kV	A	With external capacitor and TVS. See applications notes.
Conducted	EN61000-4-6	10 V rms	A	
Magnetic Fields	EN61000-4-8	100 A/m	A	

### Mechanical Details

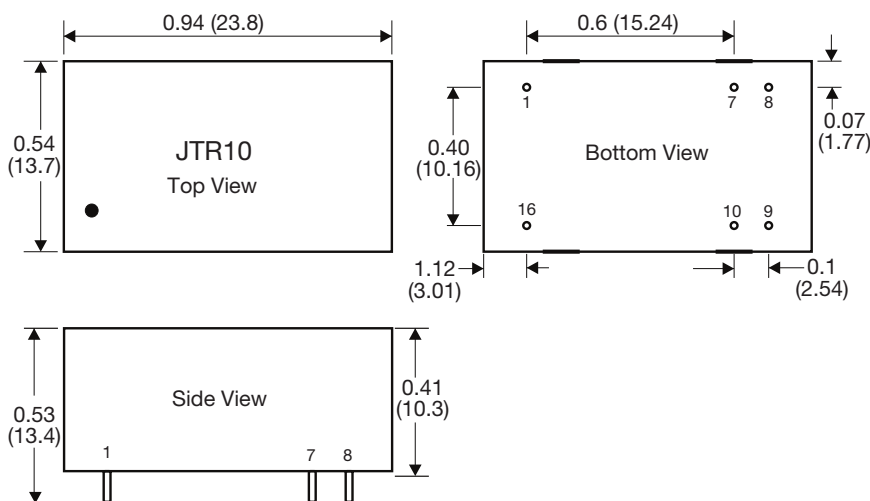

Pin	Single	Dual
1	-Vin	-Vin
7	Trim	No Connection
8	No Connection	Common
9	+Vout	+Vout
10	-Vout	-Vout
16	+Vin	+Vin

#### Notes

- All dimensions are in inches (mm)
- Weight: 0.0022 lbs (10 g) approx.
- Tolerance: X.XX±0.01 (X.X±0.25)  
X.XXX±0.005 (X.XX±0.13)
- Pin Diameter: 0.02 (0.5)
- Pin Tolerance: ±0.002 (±0.05)

### Application Notes

#### Derating Curve

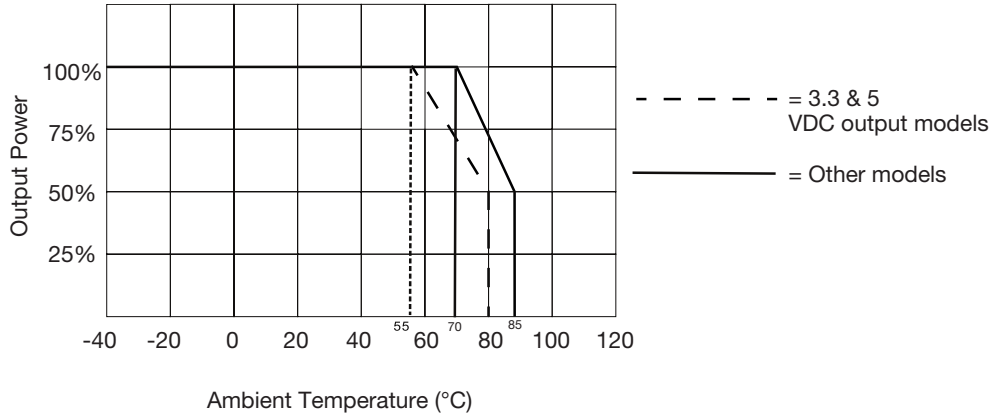

#### EFT & Surge

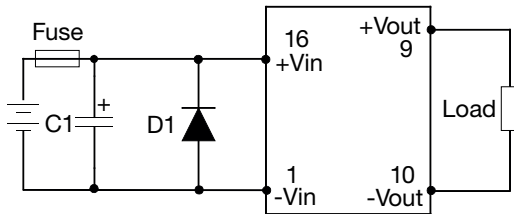

#### Input Filter to meet Class B Conducted Emissions

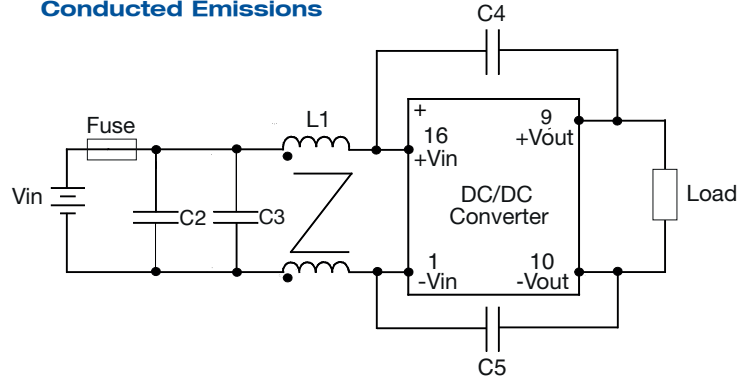

Model	C1	D1	C2	C3	L1	C4	C5
JTR1024	Nippon-chemi-con KY series 220µF, 100V	TVS, 58V, 3kW	1206, 10µF / 50V	Not fitted	LFD648075 52µH-3.14A	1206, 100pF / 2kV	1206, 100pF / 2kV
JTR1048	Nippon-chemi-con KY series 220µF, 100V	TVS, 120V, 3kW	1206, 2.2µF / 100V	1206, 2.2µF / 100V	LFD648075 175µH-1.76A	1206, 100pF / 2kV	1206, 100pF / 2kV

Select fuse rating based on application input current.

#### Output Trim

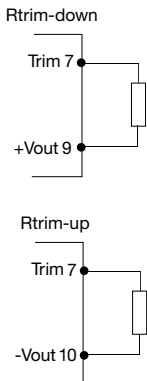

Output can be externally trimmed by using the method below. (single output models only).









Trim Down %	Nominal Vout	1	2	3	4	5	6	7	8	9	10
Rd kΩ	3V3	194.3	116.4	80.2	59	45.6	36	29	23.5	19.2	15.6
	5	217.2	101.8	63.3	44	32.6	24.9	19.4	15.2	12	9.5
	12	1812	759	458.3	315.8	232.8	178.3	140	111.3	89.2	71.7
	15	1765	738.5	445	306	225	172	134.5	106.6	85	67.9
	24	1191	532	325.2	224	164	124.3	96	75	58.6	45.5
Trim Up %	Nominal Vout	1	2	3	4	5	6	7	8	9	10
Ru kΩ	3V3	1178	237.3	127.2	84.6	62	47.9	38.3	31.4	26.1	22
	5	442.3	217.8	142.3	105.5	83	68	57.3	49.3	43.1	38.1
	12	923.4	479.9	312.4	224.7	170.7	134.1	107.8	87.8	72.1	59.6
	15	957.2	496.7	324	233.5	177.8	140.1	112.9	92.3	76.1	63.2
	24	726.5	353.5	222.4	155.5	114.8	87.6	68	53.3	41.8	32.6

## Looking for pricing, stock, or lifecycle information?

Click below to explore more details on WIN SOURCE:

-  [View JTR1024S05 on WIN SOURCE](#)
-  [XP Power Information](#)

## Optimize Your Supply Chain with WIN SOURCE Solutions

-  Global Sourcing Solution
-  Obsolete Management
-  Cost Control Management
-  Shortage Management
-  Alternative Solution
-  Excess Inventory Management