



THE DATASHEET OF SL1613SH



Honeywell Switch Sensors

1 Product features

- Low power consumption
 - 5Hzversion: 1.6uA@1.8V
 - 20Hzversion: 3.3uA@1.8V
- Wide working voltage ranges: 1.6V~5.5V
- Magnetic field threshold value optional (Bop)
 - 33Gs low threshold value
 - 46Gs high threshold value
- Single S-pole magnetic field detection
- CMOS push-pull output
- Package: SOT-23
- Working temperature ranges: -40°C~85°C
- Excellent ESD performance: HBM 8KV
- In accordance with the RoHS standard

2 Typical applications

- Laptop and tablet PC switch detection
- TWS headsets and mobile phones
- Electronic locks and valves position detection
- Water meters, gas meters and flow meters
- Non-contact detection

3 Schematic diagram for applied circuit

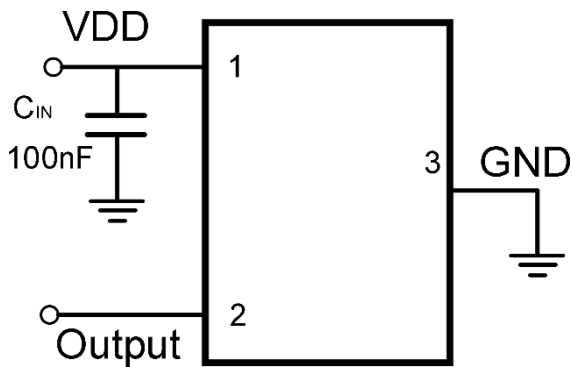

Notes: In order to remove the noise of the power supply end of the chip, there shall be a capacitance of 100nF between the power supply and the ground, which shall be close to the pin of VDD to the greatest extent.

4 Overview

SL1613 is a Honeywell switch sensor with low power consumption, which is specially designed for systems with compact spaces and that with sensitive electric quantity in batteries. The chip can provide various magnetic field threshold values, switching working frequencies and package forms, so as to adapt to varied types of applications.

When the applied S-pole magnetic induction intensity is higher than the working point B_{OP} , the chip outputs low level and keeps it, until the S-pole magnetic induction intensity is lower than the release point B_{RP} , when the chip outputs high level. The chip is installed with a temperature compensation circuit and a clock logic circuit internally, to ensure stable working point and switching frequency of the chip. The chip can provide single S-pole magnetic response with extremely low current consumption. SL1613 can work during the power supply ranges of 1.6V to 5.5V, with standard SOT-23 package.

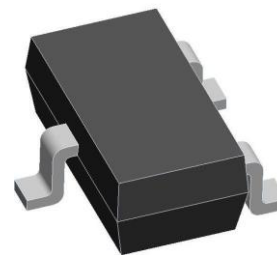

SOT-23

5 Definition of pins and information of signs

SOT-23

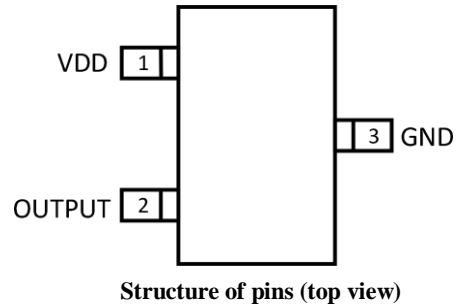

Name of pins	No. of pins	Functional description
VDD	1	Power supply input end
OUTPUT	2	Output end
GND	3	Grounding end

6 Functional block diagram

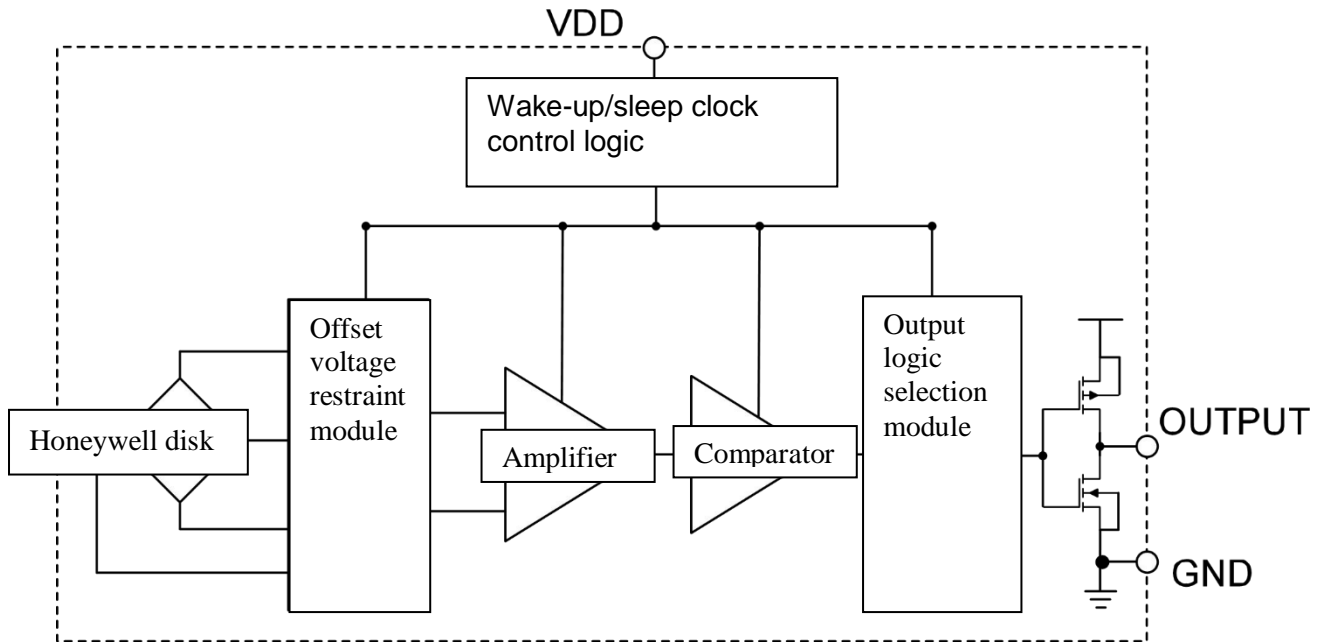

7 Switch output characteristics

As shown in the following figure, when the south pole of the magnet gets closer to the top of the chip, the magnetic induction line passes through from the bottom of the chip to the top; it is regarded that the magnetic induction intensity B is positive at this time. When the north pole of the magnet gets closer to the top of the chip, the magnetic induction line passes through from the top of the chip to the bottom; it is regarded that the magnetic induction intensity B is negative at this time.

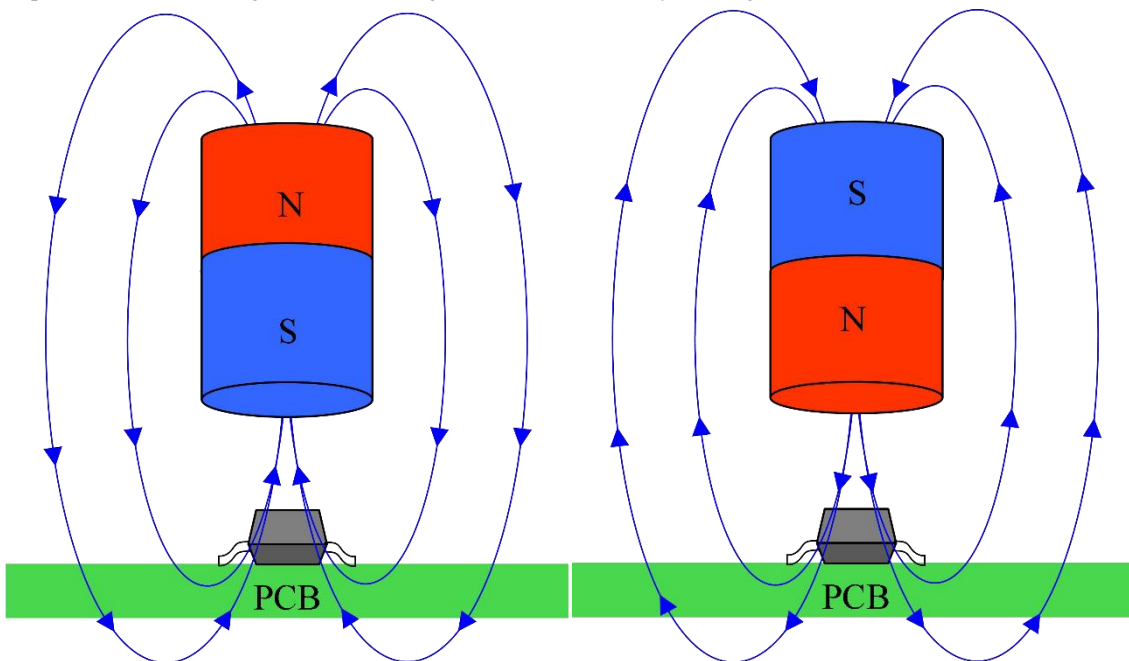

Output characteristics

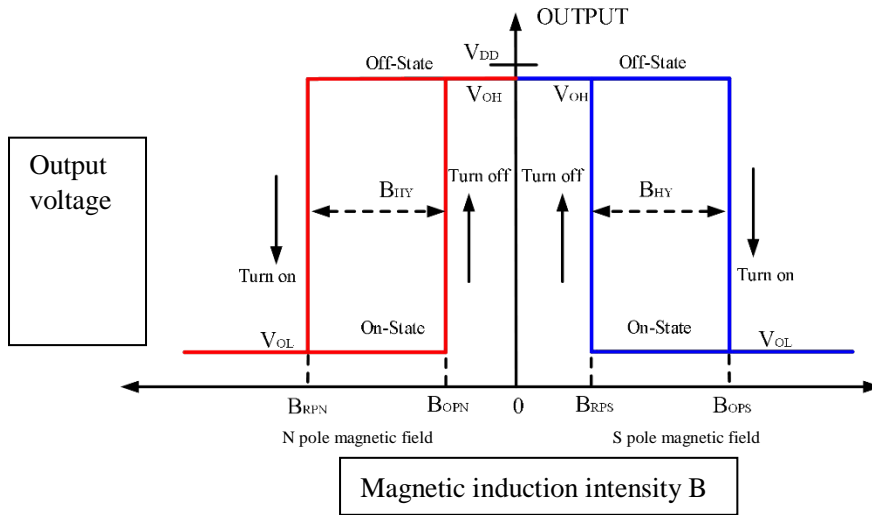

8 Product model composition

SL 1613 - X X

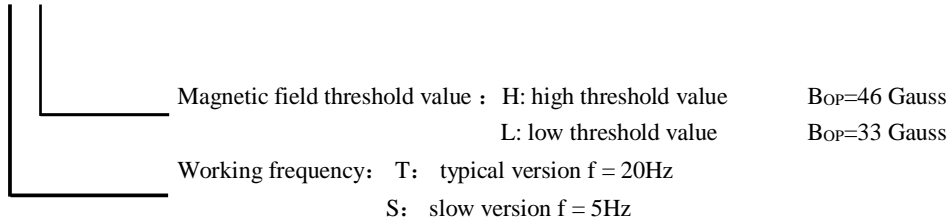

9 Absolute maximum rated value (@TA=+25°C, unless otherwise specified)

Item	Parameter description	Values	Units
V _{DD}	Supply voltage	6	V
V _{DD_REV}	Reverse supply voltage	-0.3	V
I _{OUTPUT}	Output driving current	5	mA
B	Magnetic induction intensity	No upper limit	Gauss
P _D	Package	400	mW
T _{STG}	Working temperature ranges	-50~+150	°C
T _J	Junction maximum temperature resistance	+150	°C
ESD HBM	Human body model ESD ability	8000	V

Notes: It may lead to permanent damages in condition of working exceeding the absolute maximum rated value. Long-time working at the absolute rated conditions may lead to influences on reliability of the chip.

10 Reference working conditions (@TA=+25°C, unless otherwise specified)

Item	Parameter description	Working conditions	Values	Units
V _{DD}	Supply voltage ranges	Chip working	1.6~5.5	V
T _A	Working temperature ranges	Chip working	-40~85	°C

11 Electrical parameters (@TA=+25°C, V_{DD}=1.8V unless otherwise specified)

SL 1613-TX series						
Item	Parameter description	Working conditions	Min. value	Typical value	Max. value	Units
V _{DD}	Supply voltage	Working state	1.6	—	5.5	V
V _{OL}	Output low level	I _{OUT} =1mA	—	0.02	0.1	V
V _{OH}	Output high level	I _{OUT} =1mA	V _{DD} -0.1	V _{DD} -0.02	—	V
I _{DD(AVG)}	Average current	TA=+25°C, V _{DD} =1.8V	—	3.30	—	μA
I _{DD(Awake)}	Wake-up current	TA=+25°C, V _{DD} =1.8V	—	2.0	—	mA
I _{DD(Sleep)}	Sleep current	TA=+25°C, V _{DD} =1.8V	—	1.00	—	μA
T _{AWAKE}	Wake-up time	Working state	—	50	—	μs
T _{PERIOD}	Period	Working state	—	50	—	ms

SL1613- SX series						
Item	Parameter description	Working conditions	Min. value	Typical value	Max. value	Units
VDD	Supply voltage	Working state	1.6	—	5.5	V
VOL	Output low level	$I_{OUT}=1mA$	—	0.02	0.1	V
VOH	Output high level	$I_{OUT}=1mA$	$V_{DD}-0.1$	$V_{DD}-0.02$	—	V
$I_{DD(AVG)}$	Average current	$T_A=+25^{\circ}C, V_{DD}=1.8V$	—	1.6	—	μA
$I_{DD(Awake)}$	Wake-up current	$T_A=+25^{\circ}C, V_{DD}=1.8V$	—	2.0	—	mA
$I_{DD(Sleep)}$	Sleep current	$T_A=+25^{\circ}C, V_{DD}=1.8V$	—	1.0	—	μA
T_{AWAKE}	Wake-up time	Working state	—	50	—	μs
T_{PERIOD}	Period	Working state	—	200	—	ms

Notes: After the chip is powered on (VDD is 1.6V~5.5V), it starts sampling for output, and the output state takes effect after the second working period.

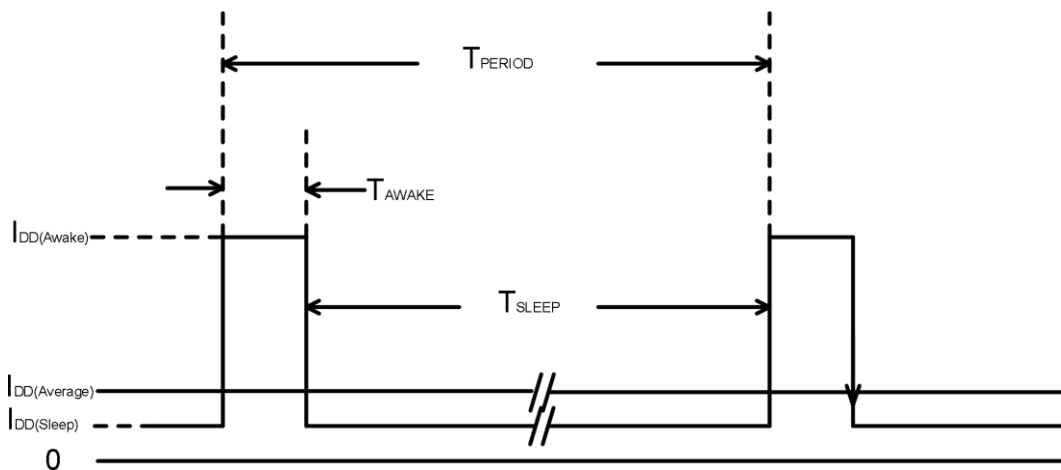

12 Magnetic parameters (@ $T_A=+25^{\circ}C, V_{DD}=1.8V$ unless otherwise specified)

Item	Parameter description	Working conditions	Min. value	Typical value	Max. value	Units
SL1613- XH series						
B_{OPS}	Magnetic field working point	$T_A=+25^{\circ}C, V_{DD}=1.8V$	40	46	52	Gauss
B_{RPS}	Magnetic field release point	$T_A=+25^{\circ}C, V_{DD}=1.8V$	26	34	38	
$B_{HY} (B_{OPS} - B_{RPS})$	Magnetic hysteresis		-	12	-	



Item	Parameter description	Working conditions	Min. value	Typical value	Max. value	Units
SL1613-XL series						
B _{OPS}	Magnetic field working point	TA=+25°C, VDD=1.8V	26	33	38	Gauss
B _{RPS}	Magnetic field release point	TA=+25°C, VDD=1.8V	16	23	28	
B _{HY} (B _{OPS} - B _{RPS})	Magnetic hysteresis		-	10	-	

13 Performance curve diagram

SL1613- XH series (high threshold value version)

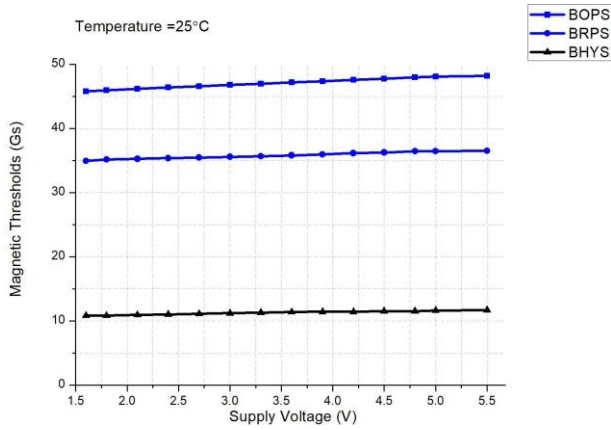

Magnetic threshold value vs. supply voltage @T_A=25°C

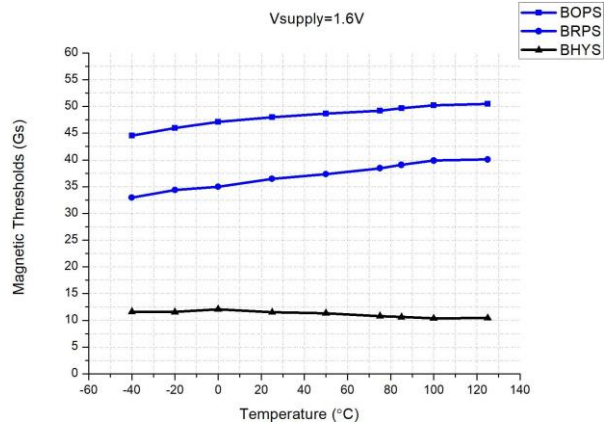

Magnetic threshold value vs temperature @VDD=1.6

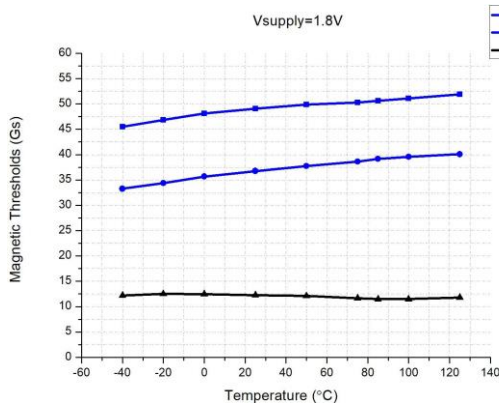

Magnetic threshold value vs temperature @VDD=1.8V

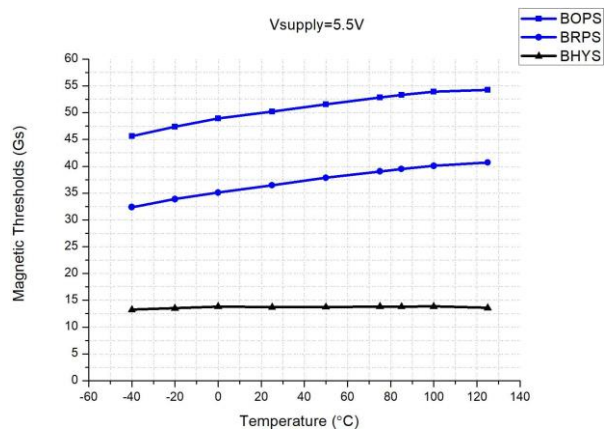

Magnetic threshold value vs temperature @VDD=5.5

SL1613 -XL series (low threshold value version)

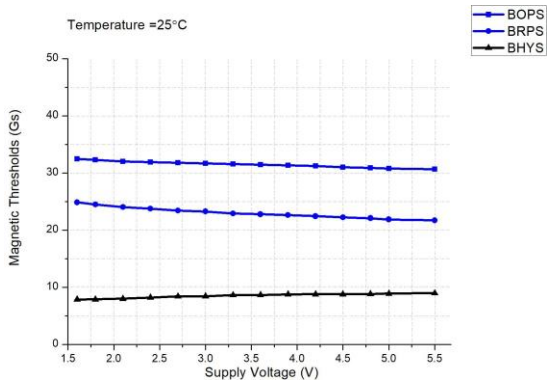

Magnetic threshold value vs. supply voltage @ $T_A=25^\circ\text{C}$

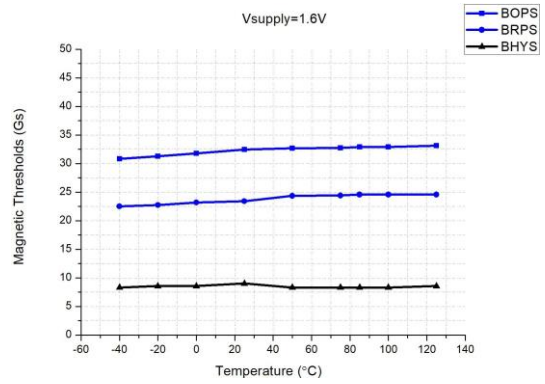

Magnetic threshold value vs temperature @ $VDD=1.6\text{v}$

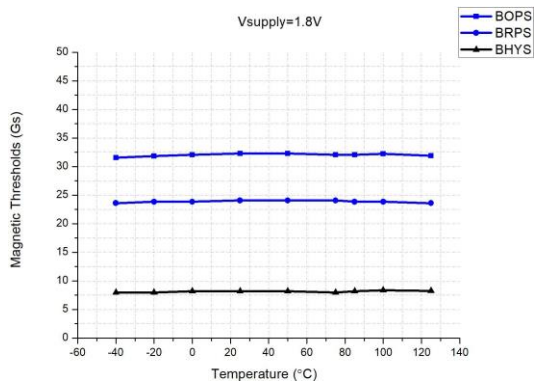

Magnetic threshold value vs temperature @ $VDD=1.8\text{V}$

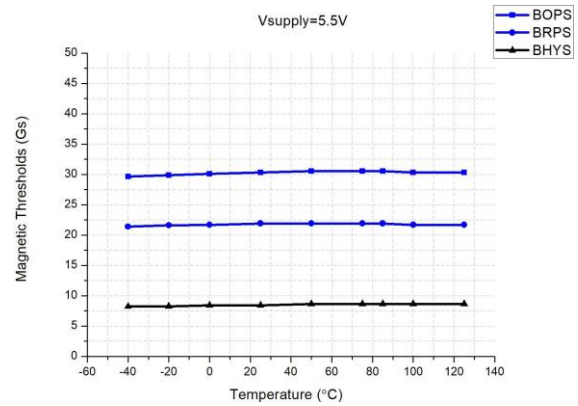

Magnetic threshold value vs temperature @ $VDD=5.5\text{v}$

SL1613- SX series (low speed version)

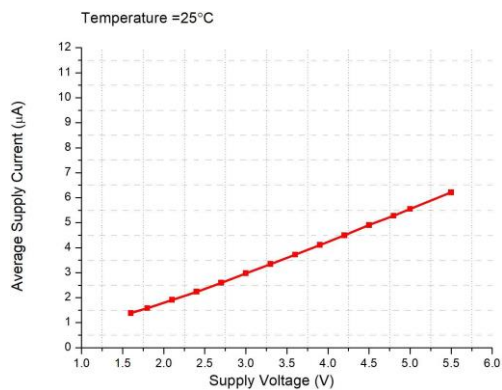

Average working current vs. supply voltage @ $T_A=25^\circ\text{C}$

SL1613- TX series (typical version)

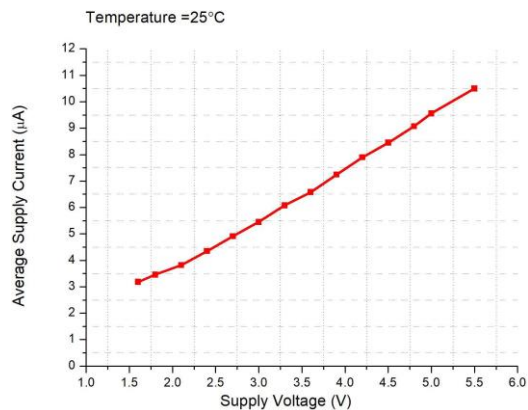

Average working current vs. supply voltage @ $T_A=25^\circ\text{C}$

14 Ordering information

Model	Package mode	Number of pins	Magnetic field threshold value (Bop)	Switching frequency	Temperature
SL1613-TH	SOT-23	3	46Gauss	20Hz	-40°C~85°C
SL1613 -TL	SOT-23	3	33Gauss	20Hz	-40°C~85°C
SL1613- SH	SOT-23	3	46Gauss	5Hz	-40°C~85°C
SL1613- SL	SOT-23	3	33Gauss	5Hz	-40°C~85°C

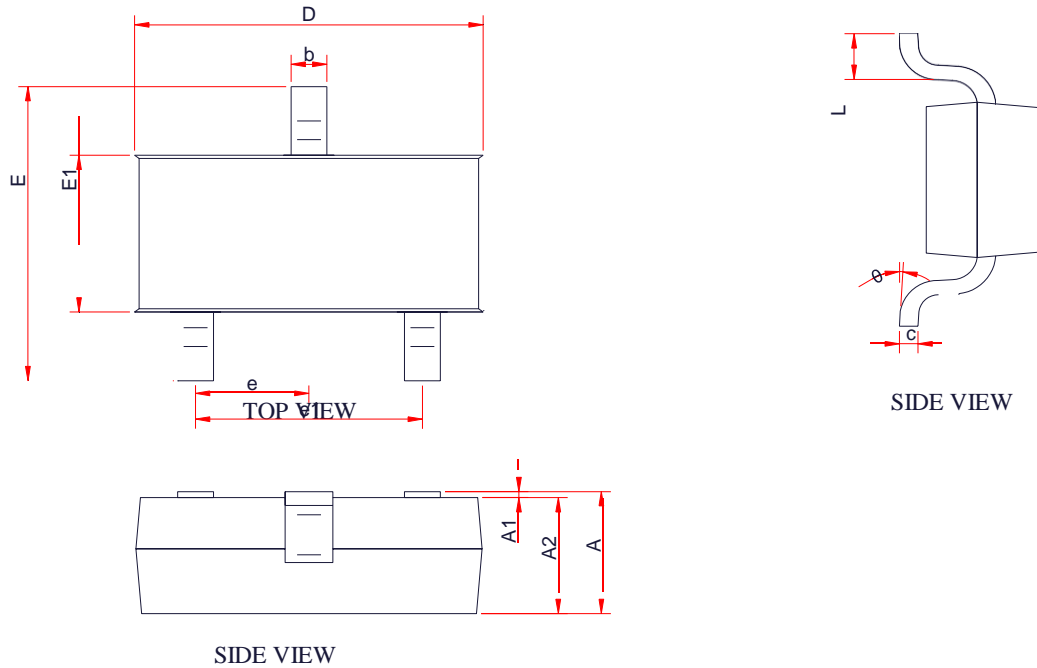
Package dimension profile drawing
SOT-23

Symbol	Dimensions in Millimeters		
	Min.	Typ.	Max.
A	-	-	1.25
A1	0.00	-	0.1
A2	1.00	1.10	1.15
b	0.30	-	0.50
c	0.10	-	0.20
D	2.82	2.95	3.02
E	2.65	2.80	2.95
E1	1.50	1.65	1.70
e	0.85	0.95	1.05
e1	1.80	1.90	2.00
L	0.30	0.45	0.60
θ	0 °	-	8 °

Looking for pricing, stock, or lifecycle information?

Click below to explore more details on WIN SOURCE:

- [View SL1613SH on WIN SOURCE](#)
- [ShenZhen SikorMicro Semicon Co. Ltd Information](#)

Optimize Your Supply Chain with WIN SOURCE Solutions

- ✓ Global Sourcing Solution
- ✓ Obsolete Management
- ✓ Cost Control Management
- ✓ Shortage Management
- ✓ Alternative Solution
- ✓ Excess Inventory Management