



THE DATASHEET OF BFR520



MICROWAVE LOW NOISE AMPLIFIER NPN SILICON EPITAXIAL TRANSISTOR

1. General Description

The chip is manufactured with the silicon epitaxy process, with characteristics such as high power gain, broadband, low noise, low leakage current and small junction capacity; in addition, it has relatively large dynamic ranges and ideal current linear features;

It is largely applied to UHF microwave, and VHF, UHF and CATV low-noise amplifiers with high-frequency broadband, including satellite TV tuners, CATV amplifiers, analog digital portable phones, radar sensor switches, RF modules and relay amplifiers built in the fiber optic transmission system, etc.

Collector-emitter breakdown voltage: $BV_{CEO}=12V$, maximum collector current: $I_C=70mA$, collector power dissipation: $P_C=300mW$, characteristic frequency: $f_T=9GHz$;

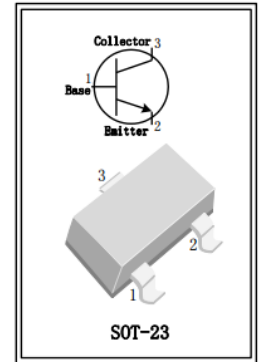

2. Maximum Ratings ($T_{amb}=25^{\circ}C$) :

Name of parameter	Symbol	Rated value	Unit
Collector-Base Voltage	V_{CBO}	20	V
Collector-emitter voltage	V_{CEO}	12	V
Emitter-Base Voltage	V_{EBO}	2.5	V
Collector current	I_C	70	mA
Power dissipation	P_T	300	mW
Maximum junction temperature	T_J	150	$^{\circ}C$
Storage temperature	T_{stg}	-65~+150	$^{\circ}C$

3. Electrical Parameter and Specification ($T_{amb}=25^{\circ}C$) :

Name of parameter	Symbol	Testing condition	Min	Typical	Max	Unit
Collector-base breakdown voltage	BV_{CBO}		20			V
Collector-emitter breakdown voltage	BV_{CEO}		12			V
Emitter-base breakdown voltage	BV_{EBO}		2.5			V
Collector cutoff current	I_{CBO}	$V_{CB}=6V, I_E=0$	-	-	0.05	μA
Direct current amplifying coefficient	h_{FE}	$V_{CE}=6V, I_C=20mA$	60	120	250	
Characteristic frequency	f_T	$V_{CE}=6V, I_C=20mA$	-	9	-	GHz
Feedback capacity	C_{re}	$I_C=i_c=0, V_{CB}=6V, f=1MHz$	-	0.4	-	pF
Collector capacity	C_C	$I_E=i_e=0, V_{CB}=6V, f=1MHz$	-	0.5	-	pF
Emitter capacity	C_e	$I_C=i_c=0, V_{EB}=0.5V, f=1MHz$	-	1.0	-	pF
Inserted power gain	$ S_{21} _2$	$I_C=20mA, V_{CE}=6V, f=900MHz$	14	15	-	dB
Noise coefficient	NF	$V_{CE}=6V, I_C=5mA, f=900MHz$	-	1.1	1.6	dB
		$V_{CE}=6V, I_C=20mA, f=900MHz$	-	1.6	2.1	dB
		$V_{CE}=8V, I_C=5mA, f=2GHz$	-	1.9	-	dB
Maximum unilateral power gain	G_{UM}	$I_C=20mA, V_{CE}=6V, f=900MHz$	15	16	-	dB
		$I_C=20mA, V_{CE}=6V, f=2GHz$	-	9	-	dB
Output voltage	V_o			270		mV
Gain compression of the output power at 1dB	PL1	$I_C=20mA, V_{CE}=6V, R_L=50\Omega, f=900MHz$	-	17	-	dB
ITO Third Order Intercept Point			-	26	-	dBm

including:

$$G_{UM} = 10 \log \frac{|S_{21}|^2}{(1 - S_{11})^2 (1 - S_{22})^2} \text{ dB}$$

4. Typical Characteristic Curves:

TYPICAL CHARACTERISTICS
($T_A=25^\circ\text{C}$, unless otherwise specified)

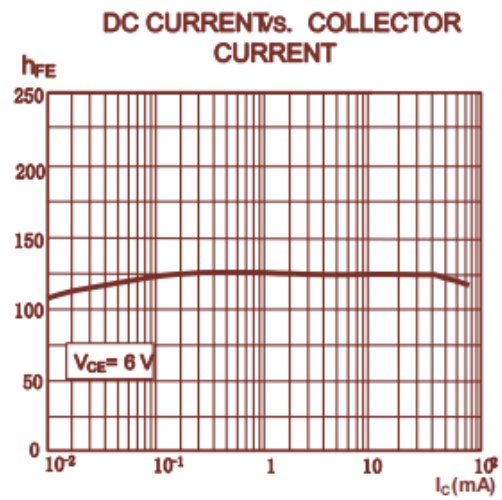
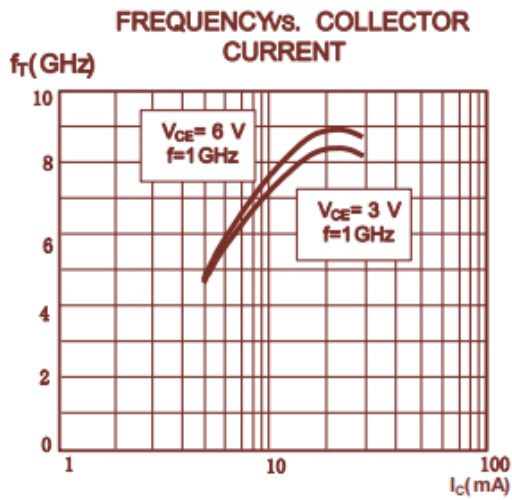
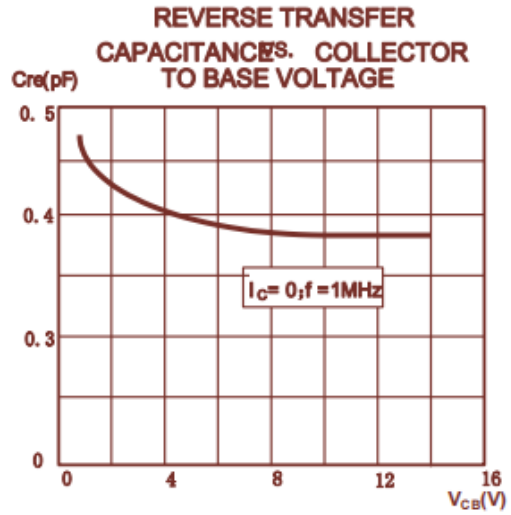
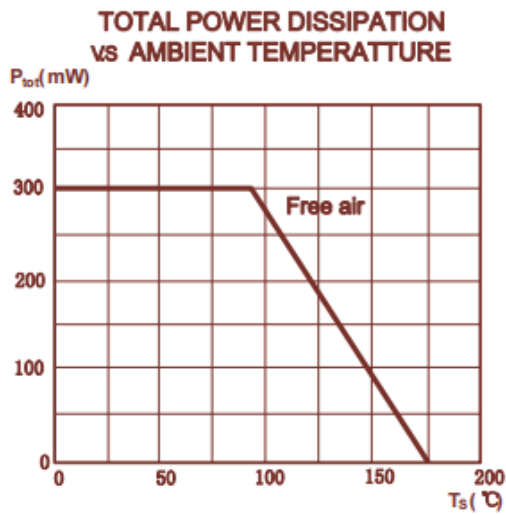

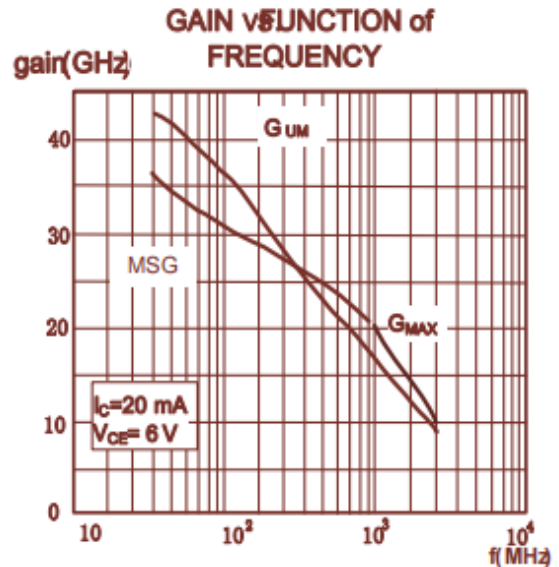
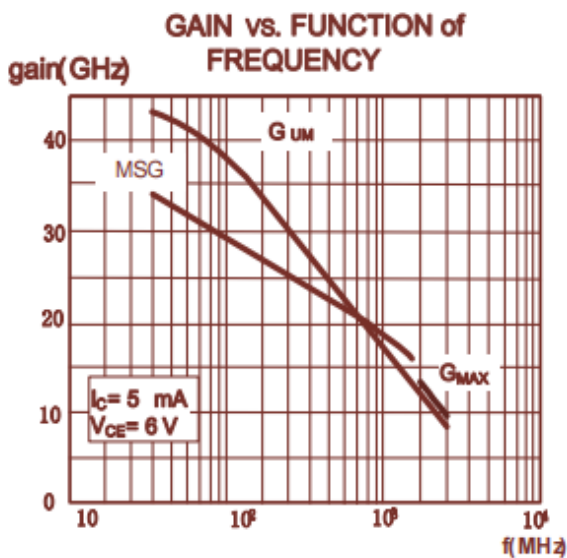
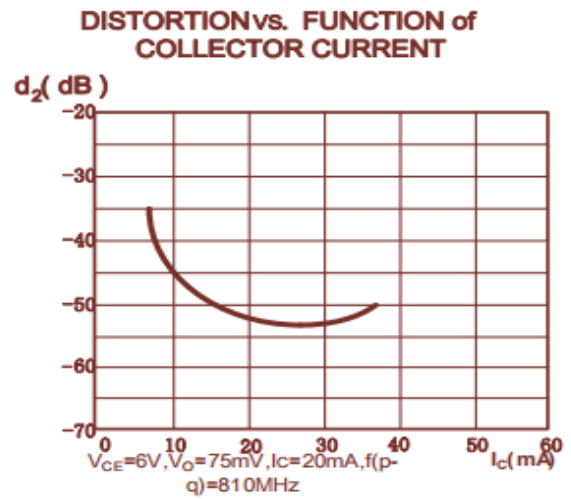
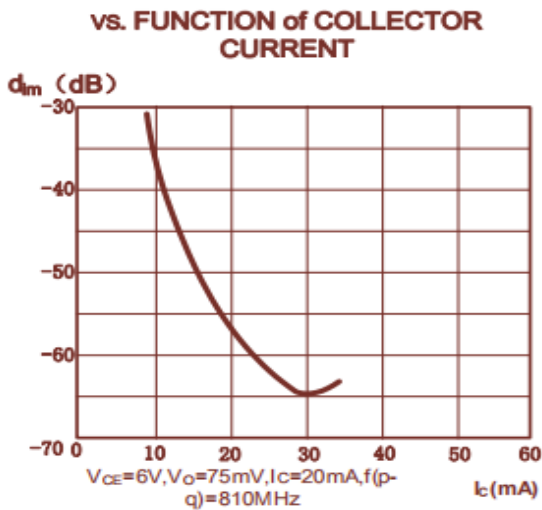
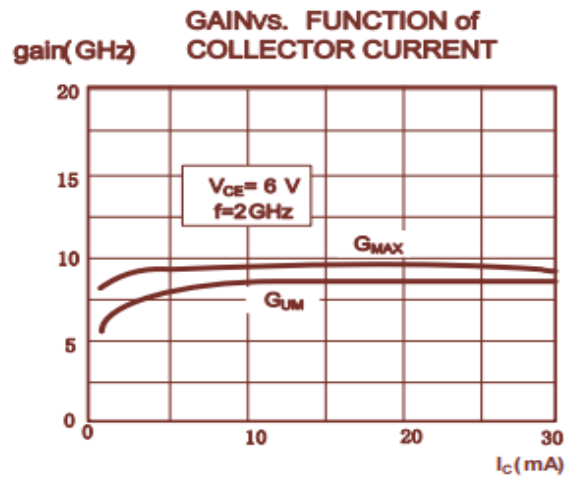
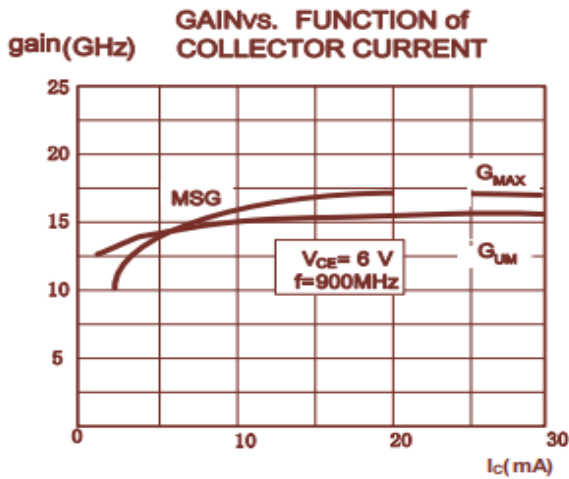

5. Package Dimension Diagram :

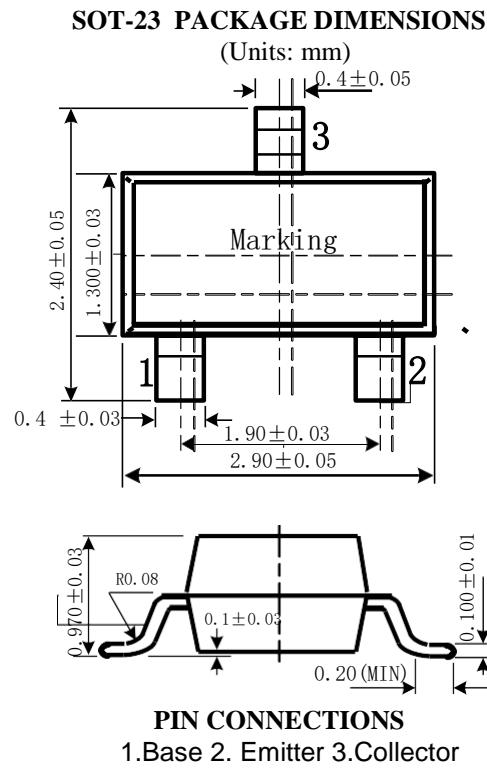

Looking for pricing, stock, or lifecycle information?

Click below to explore more details on WIN SOURCE:

- [View BFR520 on WIN SOURCE](#)
- [ShenZhen SikorMicro Semicon Co. Ltd Information](#)

Optimize Your Supply Chain with WIN SOURCE Solutions

- ✓ Global Sourcing Solution
- ✓ Obsolete Management
- ✓ Cost Control Management
- ✓ Shortage Management
- ✓ Alternative Solution
- ✓ Excess Inventory Management