



**THE DATASHEET OF
1N5819WT**



Plastic-Encapsulate Diodes

SCHOTTKY BARRIER DIODE

FEATURES

- Low Forward Voltage Drop
- Guard Ring Construction for Transient Protection
- Low Reverse Recovery Time
- Low Reverse Capacitance

MARKING: S4

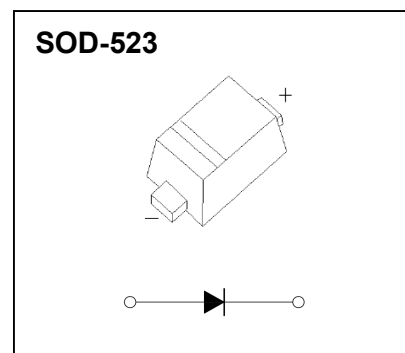

MAXIMUM RATINGS ($T_a=25^{\circ}\text{C}$ unless otherwise noted)

Symbol	Parameter	Value	Unit
V_{RRM}	Peak Repetitive Reverse Voltage	40	V
V_{RWM}	Working Peak Reverse Voltage		
V_R	DC Blocking Voltage		
$V_{R(RMS)}$	RMS Reverse Voltage	28	V
I_{FM}	Forward Continuous Current	350	mA
I_{FSM}	Non-Repetitive Peak Forward Surge Current@t=8.3ms	2	A
P_D	Power Dissipation	150	mW
$R_{\theta JA}$	Thermal Resistance From Junction To Ambient	667	$^{\circ}\text{C}/\text{W}$
T_j	Junction Temperature	125	$^{\circ}\text{C}$
T_{stg}	Storage Temperature	-55~+150	$^{\circ}\text{C}$

ELECTRICAL CHARACTERISTICS($T_a=25^{\circ}\text{C}$ unless otherwise specified)

Parameter	Symbol	Test conditions	Min	Typ	Max	Unit
Reverse voltage	$V_{(BR)}$	$I_R=100\mu\text{A}$	40			V
Reverse current	I_R	$V_R=30\text{V}$			5	μA
		$V_R=20\text{V}$			2	
		$V_R=10\text{V}$			1	
Forward voltage	V_F	$I_F=1\text{mA}$		0.27		V
		$I_F=5\text{mA}$		0.32		
		$I_F=20\text{mA}$			0.37	
		$I_F=200\text{mA}$			0.6	
Total capacitance	C_{tot}	$V_R=0\text{V}, f=1\text{MHz}$		50		pF
Reverse recovery time	t_{rr}	$I_F=I_R=200\text{mA}, I_{rr}=0.1 \times I_R, R_L=100\Omega$		10		ns

Typical Characteristics

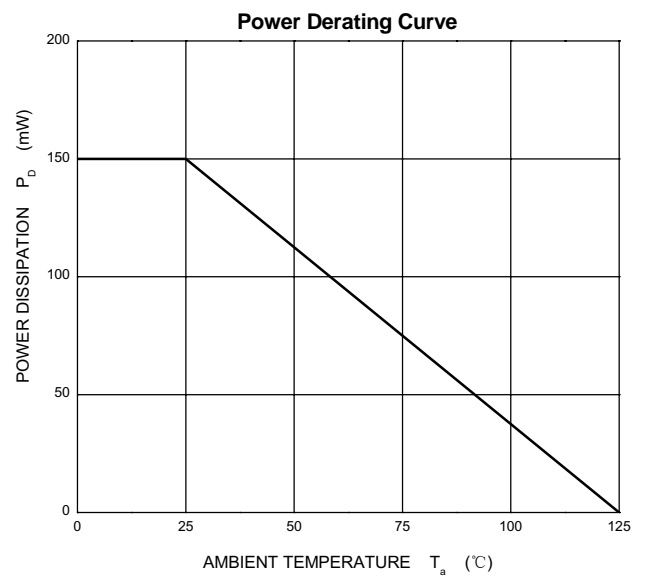
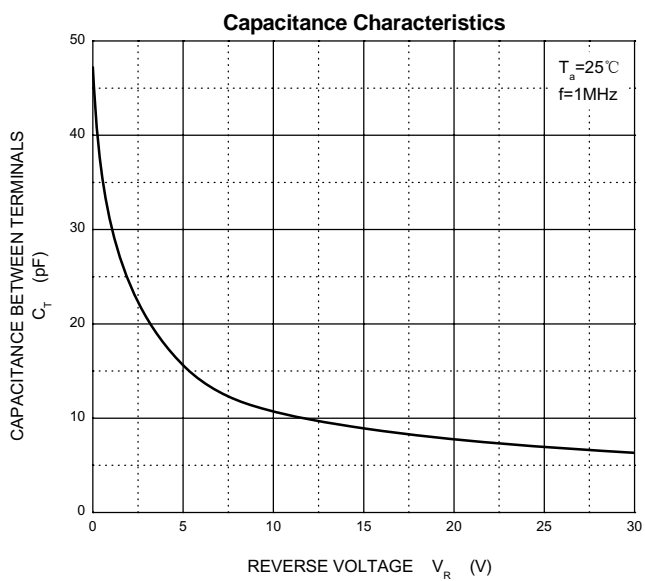
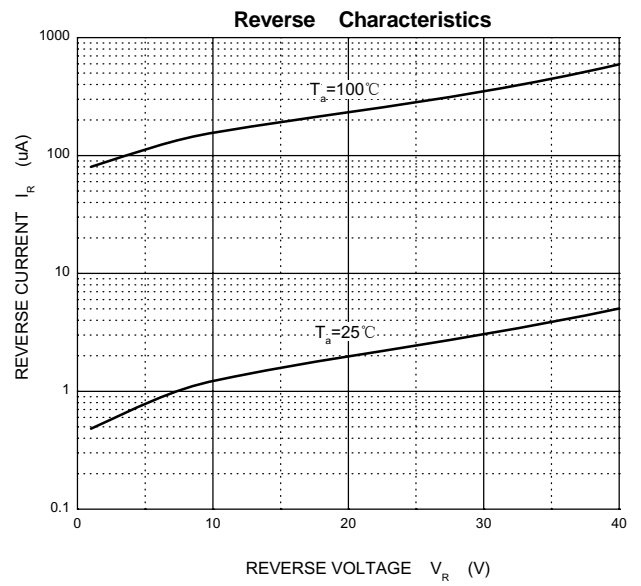
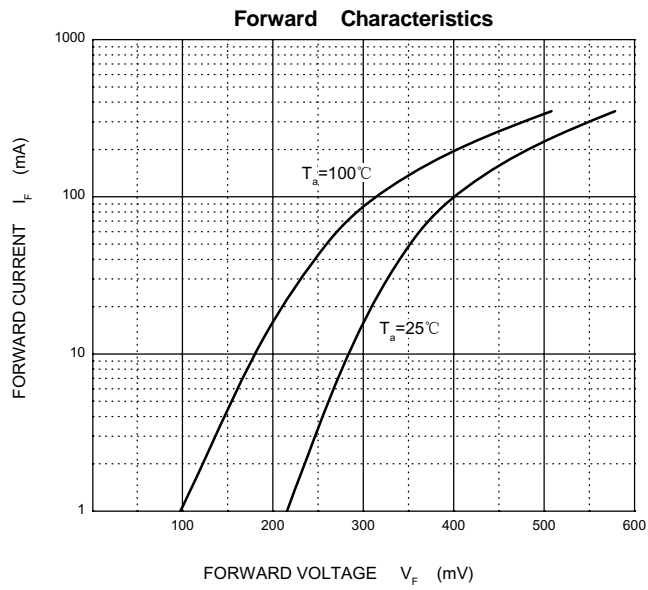

SOD-523 Package Outline Dimensions

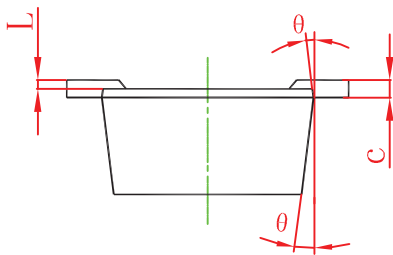
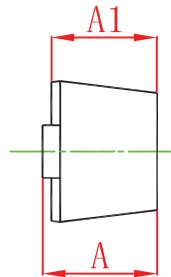
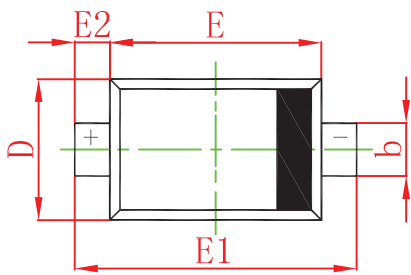

Symbol	Dimensions In Millimeters		Dimensions In Inches	
	Min	Max	Min	Max
A	0.510	0.770	0.020	0.031
A1	0.500	0.700	0.020	0.028
b	0.250	0.350	0.010	0.014
c	0.080	0.150	0.003	0.006
D	0.750	0.850	0.030	0.033
E	1.100	1.300	0.043	0.051
E1	1.500	1.700	0.059	0.067
E2	0.200 REF		0.008 REF	
L	0.010	0.070	0.001	0.003
θ	7° REF		7° REF	

SOD-523 Suggested Pad Layout

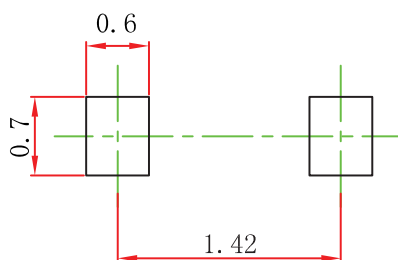

Note:

1. Controlling dimension: in millimeters.
2. General tolerance: $\pm 0.05\text{mm}$.
3. The pad layout is for reference purposes only.

Looking for pricing, stock, or lifecycle information?

Click below to explore more details on WIN SOURCE:

- [View 1N5819WT on WIN SOURCE](#)
- [ShenZhen SikorMicro Semicon Co. Ltd Information](#)

Optimize Your Supply Chain with WIN SOURCE Solutions

- ✓ Global Sourcing Solution
- ✓ Obsolete Management
- ✓ Cost Control Management
- ✓ Shortage Management
- ✓ Alternative Solution
- ✓ Excess Inventory Management