



**THE DATASHEET OF
1N4007WS**



■ Features

- Fast Switching Speed
- For General Purpose Switching Applications.
- High Conductance
- Surface Mount Package Ideally Suited for Automatic Insertion

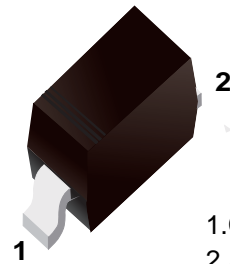

1.Cathode
2.Anode

■ Simplified outline(SOD-323)

Top View 

■ Absolute Maximum Ratings Ta = 25°C

Parameter	Symbol	Rating	Unit
Reverse Voltage	V _{RM}	300	V
Peak Repetitive Peak Reverse Voltage	V _{RRM}	300	
Working Peak Reverse Voltage	V _{RWM}		
DC Blocking Voltage	V _R		
RMS Reverse Voltage	V _{R(RMS)}	71	mA
Average Rectified Output Current	I _o	300	
Forward Continuous Current	I _{FM}	400	A
Peak Forward Surge Current @ t=1us	I _{FSM}	2	
@ t=1s		1	
Power Dissipation	P _d	500	mW
Thermal Resistance Junction to Ambient	R _{θJA}	250	°C/W
Junction Temperature	T _J	150	°C
Storage Temperature range	T _{stg}	-55 to 150	

■ Electrical Characteristics Ta = 25°C

Parameter	Symbol	Test Conditions	Min	Typ	Max	Unit
Reverse breakdown voltage	V _R	I _R = 100uA	100			V
Forward voltage	V _{F1}	I _F = 1mA			0.715	
	V _{F2}	I _F = 10 mA			0.855	
	V _{F3}	I _F = 50 mA			1	
	V _{F4}	I _F = 150 mA			1.25	
Reverse voltage leakage current	I _{R1}	V _R = 75 V			1	uA
	I _{R2}	V _R =20 V			25	nA
Junction capacitance	C _j	V _R = 0 V, f= 1 MHz			2	pF
Reverse recovery time	t _{rr}	I _F =I _R =10mA, I _{rr} =0.1xI _R , R _L =100Ω			4	ns

■ Typical Characteristics

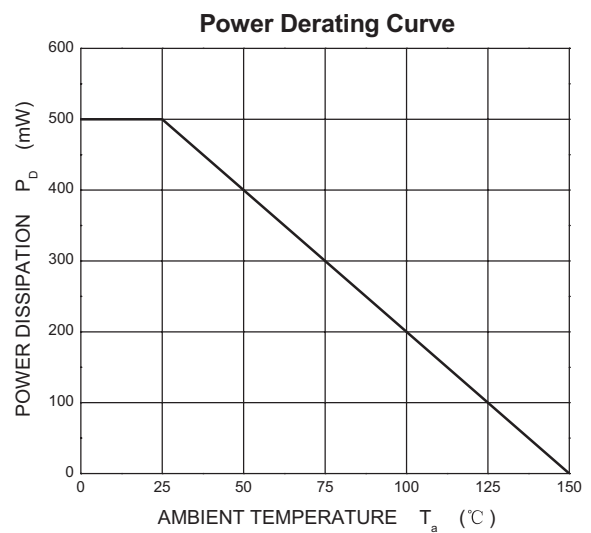
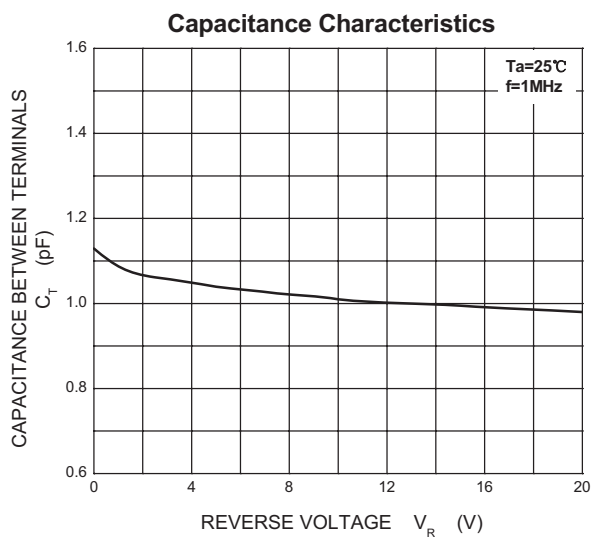
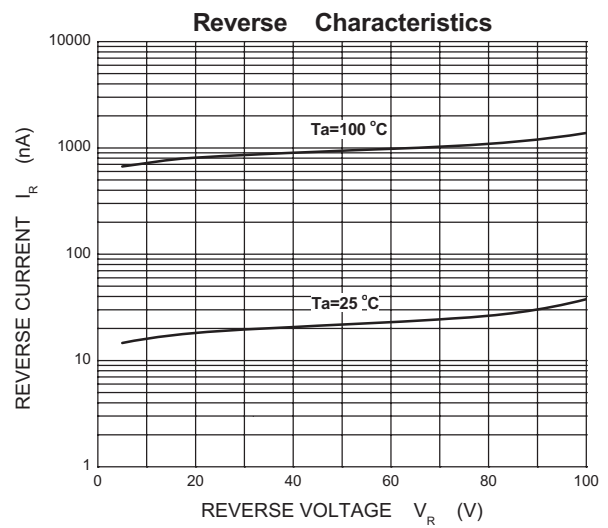
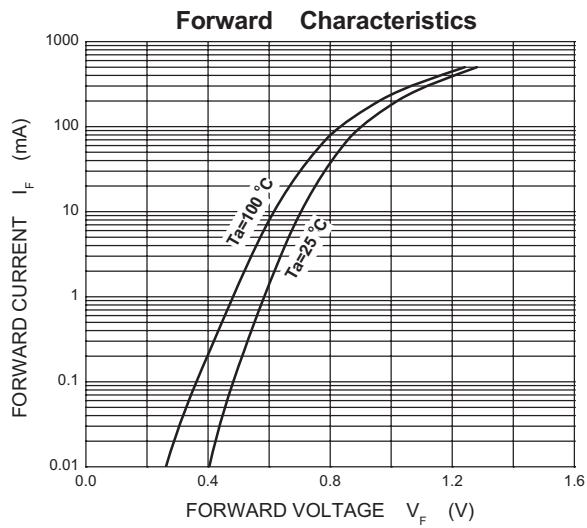

■ SOD-323

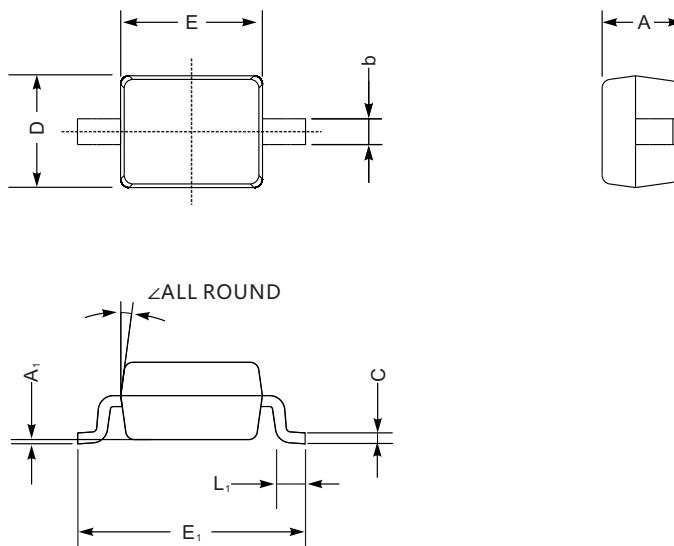

SOD-323 mechanical data

UNIT		A	C	D	E	E ₁	b	L ₁	A ₁	∠
mm	max	1.1	0.15	1.4	1.8	2.75	0.4	0.45	0.2	9°
	min	0.8	0.08	1.2	1.4	2.55	0.25	0.2	—	
mil	max	43	5.9	55	70	108	16	16	8	
	min	32	3.1	47	63	100	9.8	7.9	—	

■ The recommended mounting pad size

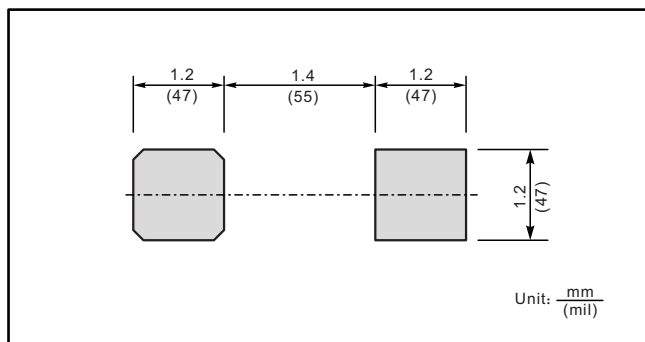

Looking for pricing, stock, or lifecycle information?

Click below to explore more details on WIN SOURCE:

- [View 1N4007WS on WIN SOURCE](#)
- [ShenZhen SikorMicro Semicon Co. Ltd Information](#)

Optimize Your Supply Chain with WIN SOURCE Solutions

- ✓ Global Sourcing Solution
- ✓ Obsolete Management
- ✓ Cost Control Management
- ✓ Shortage Management
- ✓ Alternative Solution
- ✓ Excess Inventory Management