

## Chip Resistor Array

Type: **EXB 14V, 18V, 24V, 28V, N8V, 2HV, 34V, V4V, 38V, V8V, S8V**



### Features

- High density  
 2 resistors in 0.8 mm × 0.6 mm size / 0302 inch size : EXB14V  
 4 resistors in 1.4 mm × 0.6 mm size / 0502 inch size : EXB18V  
 2 resistors in 1.0 mm × 1.0 mm size / 0404 inch size : EXB24V  
 4 resistors in 2.0 mm × 1.0 mm size / 0804 inch size : EXB28V, EXBN8V  
 8 resistors in 3.8 mm × 1.6 mm size / 1506 inch size : EXB2HV  
 2 resistors in 1.6 mm × 1.6 mm size / 0606 inch size : EXB34V, EXBV4V  
 4 resistors in 3.2 mm × 1.6 mm size / 1206 inch size : EXB38V, EXBV8V  
 4 resistors in 5.1 mm × 2.2 mm size / 2009 inch size : EXBS8V
- Improvement of placement efficiency  
 Placement efficiency of Chip Resistor Array is two, four or eight times of the flat type chip resistor
- Reference Standard...IEC 60115-9, JIS C 5201-9, EIAJ RC-2129
- AEC-Q200 qualified (EXB2, EXB3)
- RoHS compliant

■ **As for Packaging Methods, Land Pattern, Soldering Conditions and Safety Precautions,**  
 Please see Data Files

### Explanation of Part Numbers

1	2	3	4	5	6	7	8	9	10	11
E	X	B	V	8	V	4	7	2	J	V

Product Code	Code	Inch	Construction	Schematics	Resistance Value	Resistance Tolerance	Packaging Methods	
Thick Film Chip Resistor Networks	14	0201×2	Convex Terminal	V Isolated type	The first two digits are significant figures of resistance value and the third one denotes the number of zeros following. Jumper is expressed by R00 Example : 222 → 2.2k Ω	J ±5 % 0 Jumper	Code	Part No.
	18	0201×4	Flat Terminal				Nil	Embossed Carrier Taping 4 mm pitch, 2,500 pcs.
	24	0402×2	Convex Terminal	X		Punched Carrier Taping 2 mm pitch, 10,000 pcs.	EXB14V, 18V, 24V, 28V, N8V	
	28	0402×4	Convex Terminal	V		Punched Carrier Taping 4 mm pitch, 5,000 pcs.	EXB2HV, 34V, 38V, V4V, V8V	
	2H	0602×8	Convex Terminal					
	34	0603×2	Convex Terminal					
	38	0603×4	Convex Terminal					
	N8	0402×4	Concave Terminal					
	V4	0603×2	Concave Terminal					
	V8	0603×4	Concave Terminal					
	S8	0805×4	Concave Terminal					

### Construction (Example : Concave Terminal)

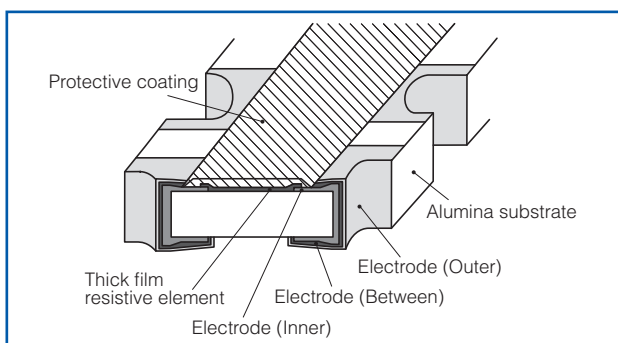

### Schematics

- Isolated type



## Ratings

### [For Resistor]

Part No. (inch size)	Power Rating at 70 °C (W / element)	Limiting Element Voltage <sup>(1)</sup> (V)	Maximum Overload Voltage <sup>(2)</sup> (V)	Resistance Tolerance (%)	Resistance Range (Ω)	T.C.R. ( $\times 10^{-6}/^{\circ}\text{C}$ )	Category Temperature Range (°C)	AEC-Q200 Grade
EXB14V (0201×2)	0.031	12.5	25	±5	10 to 1M (E24)	<10 Ω : -200 to +600  10 Ω to 1M Ω : ±200	-55 to +125	-
EXB18V (0201×2)	0.031 (0.1 W / package)	12.5	25	±5	10 to 1M (E24)		-55 to +125	-
EXB24V (0402×2)	0.063	50	100	±5	1 to 1M (E24)		-55 to +125	Grade 1
EXB28V (0402×4)	0.063	50	100	±5	1 to 1M (E24)		-55 to +125	Grade 1
EXB2HV (0602×8)	0.063 (0.25 W / package)	25	50	±5	10 to 1M (E24)		-55 to +125	Grade 1
EXB34V (0603×2)	0.063	50	100	±5	1 to 1M (E24)		-55 to +125	Grade 1
EXB38V (0603×4)	0.063	50	100	±5	1 to 1M (E24)		-55 to +125	Grade 1
EXBN8V (0402×4)	0.031	50	100	±5	10 to 1M (E24)		-55 to +125	-
EXBV4V (0603×2)	0.063	50	100	±5	10 to 1M (E24)		-55 to +125	-
EXBV8V (0603×4)	0.063	50	100	±5	10 to 1M (E24)		-55 to +125	-
EXBS8V (0805×4)	0.1	100	200	±5	10 to 1M (E24)		-55 to +125	-

- (1) Rated Continuous Working Voltage (RCWW) shall be determined from  $RCWW = \sqrt{\text{Power Rating} \times \text{Resistance Values}}$ , or Limiting Element Voltage listed above, whichever less.  
 (2) Overload Test Voltage (OTV) shall be determined from  $OTV = \text{Specified Magnification (refer to performance)} \times RCWW$  or Maximum Overload Voltage listed above, whichever less.

### [For Jumper]

Part No. (inch size)	Rated Current (A / element)	Maximum Overload Current <sup>(1)</sup> (A)
EXB14V (0201×2)	0.5	1
EXB18V (0201×4)	0.5	1
EXB24V (0402×2)	1	2
EXB28V (0402×4)	1	2
EXB2HV (0602×8)	1	2
EXB34V (0603×2)	1	2
EXB38V (0603×4)	1	2
EXBN8V (0402×4)	1	2
EXBV4V (0603×2)	1	2
EXBV8V (0603×4)	1	2
EXBS8V (0805×4)	2	4

(1) Overload test current

### Power Derating Curve

For resistors operated in ambient temperatures above 70 °C, power rating shall be derated in accordance with the figure below.



## Dimensions in mm (not to scale)

### (1) Convex Terminal type



Part No. (inch size)	Dimensions (mm)								Mass (Weight) [g/1000 pcs.]
	L	W	T	A1	A2	B	P	G	
EXB14V (0201×2)	0.80 <sup>±0.10</sup>	0.60 <sup>±0.10</sup>	0.35 <sup>±0.10</sup>	0.35 <sup>±0.10</sup>	—	0.15 <sup>±0.10</sup>	(0.50)	0.15 <sup>±0.10</sup>	0.5
EXB24V (0402×2)	1.00 <sup>±0.10</sup>	1.00 <sup>±0.10</sup>	0.35 <sup>±0.10</sup>	0.40 <sup>±0.10</sup>	—	0.18 <sup>±0.10</sup>	(0.65)	0.25 <sup>±0.10</sup>	1.2
EXB28V (0402×4)	2.00 <sup>±0.10</sup>	1.00 <sup>±0.10</sup>	0.35 <sup>±0.10</sup>	0.45 <sup>±0.10</sup>	0.35 <sup>±0.10</sup>	0.20 <sup>±0.10</sup>	(0.50)	0.25 <sup>±0.10</sup>	2.0
EXB2HV (0602×8)	3.80 <sup>±0.10</sup>	1.60 <sup>±0.10</sup>	0.45 <sup>±0.10</sup>	0.35 <sup>±0.10</sup>	0.35 <sup>±0.10</sup>	0.30 <sup>±0.10</sup>	(0.50)	0.30 <sup>±0.10</sup>	9.0
EXB34V (0603×2)	1.60 <sup>±0.20</sup>	1.60 <sup>±0.15</sup>	0.50 <sup>±0.10</sup>	0.65 <sup>±0.15</sup>	—	0.30 <sup>±0.20</sup>	(0.80)	0.30 <sup>±0.20</sup>	3.5
EXB38V (0603×4)	3.20 <sup>±0.20</sup>	1.60 <sup>±0.15</sup>	0.50 <sup>±0.10</sup>	0.65 <sup>±0.15</sup>	0.45 <sup>±0.15</sup>	0.30 <sup>±0.20</sup>	(0.80)	0.35 <sup>±0.20</sup>	7.0

( ) Reference

### (2) Concave Terminal type

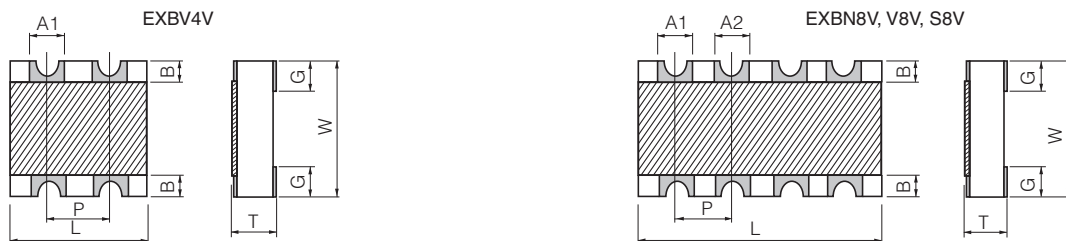

Part No. (inch size)	Dimensions (mm)								Mass (Weight) [g/1000 pcs.]
	L	W	T	A1	A2	B	P	G	
EXBN8V (0402×4)	2.00 <sup>±0.10</sup>	1.00 <sup>±0.10</sup>	0.45 <sup>±0.10</sup>	0.30 <sup>±0.10</sup>	0.30 <sup>±0.10</sup>	0.20 <sup>±0.15</sup>	(0.50)	0.30 <sup>±0.15</sup>	3.0
EXBV4V (0603×2)	1.60 <sup>+0.20/-0.10</sup>	1.60 <sup>+0.20/-0.10</sup>	0.60 <sup>±0.10</sup>	0.60 <sup>±0.10</sup>	—	0.30 <sup>±0.15</sup>	(0.80)	0.45 <sup>±0.15</sup>	5.0
EXBV8V (0603×4)	3.20 <sup>+0.20/-0.10</sup>	1.60 <sup>+0.20/-0.10</sup>	0.60 <sup>±0.10</sup>	0.60 <sup>±0.10</sup>	0.60 <sup>±0.10</sup>	0.30 <sup>±0.15</sup>	(0.80)	0.45 <sup>±0.15</sup>	10
EXBS8V (0805×4)	5.08 <sup>+0.20/-0.10</sup>	2.20 <sup>+0.20/-0.10</sup>	0.70 <sup>±0.20</sup>	0.80 <sup>±0.15</sup>	0.80 <sup>±0.15</sup>	0.50 <sup>±0.15</sup>	(1.27)	0.55 <sup>±0.15</sup>	30

( ) Reference

### (3) Flat Terminal type



Part No. (inch size)	Dimensions (mm)								Mass (Weight) [g/1000 pcs.]
	L	W	T	A1	A2	B	P	G	
EXB18V (0201×4)	1.40±0.10	0.60±0.10	0.35±0.10	0.20±0.10	0.20±0.10	0.10±0.10	(0.40)	0.20±0.10	1.0

( ) Reference

## Performance

Test Item	Performance Requirements	Test Conditions
Resistance	Within Specified Tolerance	20 °C
T. C. R.	Within Specified T. C. R.	+25 °C/+125 °C
Overload	±2%	Rated Voltage × 2.5, 5 s Jumper type : Max. Overload Current, 5 s
Resistance to Soldering Heat	±1%	270 °C, 10 s
Rapid Change of Temperature	±1%	-55 °C (30min.) / +125 °C (30min.), 100 cycles
High Temperature Exposure	±1%	+125 °C , 1000 h
Damp Heat, Steady State	±1%	60 °C, 90% to 95 %RH, 1000 h
Load Life in Humidity	±3%	60 °C, 90% to 95 %RH, Rated Voltage (Jumper type: Rated Current), 1.5 h ON/0.5 h OFF cycle, 1000 h
Endurance at 70 °C	±3%	70 °C, Rated Voltage(Jumper type: Rated Current), 1.5 h ON/0.5 h OFF cycle, 1000 h

## ⚠ Safety Precautions (Common precautions for Surface Mount Resistors)

The following are precautions for individual products. Please also refer to the common precautions for Fixed Resistors in this catalog.

1. Take measures against mechanical stress during and after mounting of Surface Mount Resistors (hereafter called the resistors) so as not to damage their electrodes and protective coatings.  
Be careful not to misplace the resistors on the land patterns. Otherwise, solder bridging may occur.
2. Keep the rated power and ambient temperature within the specified derating curve.  
Some circuit boards, wiring patterns, temperatures of heat generated by adjacent components, or ambient temperatures can become factors in the rise of the temperature of the resistors, regardless of the level of power applied. Therefore, check the conditions before use and optimize them so as not to damage the boards and peripheral components.  
Make sure to contact us before using the resistors under special conditions.
3. If a transient load (heavy load in a short time) like a pulse is expected to be applied, check and evaluate the operations of the resistors when installed in your products before use.  
Never exceed the rated power. Otherwise, the performance and/or reliability of the resistors may be impaired.
4. Before using halogen-based or other high-activity flux, check the possible effects of the flux residues on the performance and reliability of the resistors.
5. When soldering with a soldering iron, never touch the resistors' bodies with the tip of the soldering iron. When using a soldering iron with a high temperature tip, finish soldering as quickly as possible (within three seconds at 350 °C max.).
6. As the amount of applied solder becomes larger, the mechanical stress applied to the resistors increases, causing problems such as cracks and faulty characteristics. Avoid applying an excessive amounts of solder.
7. When the resistors' protective coatings are chipped, flawed, or removed, the characteristics of the resistors may be impaired. Take special care not to apply mechanical shock during automatic mounting or cause damage during handling of the boards with the resistors mounted.
8. Do not apply shock to the resistors or pinch them with a hard tool (e.g. pliers and tweezers). Otherwise, the resistors' protective coatings and bodies may be chipped, affecting their performance.
9. Avoid excessive bending of printed circuit boards in order to protect the resistors from abnormal stress.
10. Do not immerse the resistors in solvent for a long time. Before using solvent, carefully check the effects of immersion.
11. Transient voltage  
If there is a possibility that the transient phenomenon (significantly high voltage applied in a short time) may occur or that a high voltage pulse may be applied, make sure to evaluate and check the characteristics of Fixed Metal (Oxide) Film Resistors mounted on your product rather than only depending on the calculated power limit or steady-state conditions to complete the design or decide to use the resistors.
12. Do not apply excessive tension to the terminals.

## ⚠ Safety Precautions (Common precautions for Fixed Resistors)

- When using our products, no matter what sort of equipment they might be used for, be sure to make a written agreement on the specifications with us in advance. The design and specifications in this catalog are subject to change without prior notice.
- Do not use the products beyond the specifications described in this catalog.
- This catalog explains the quality and performance of the products as individual components. Before use, check and evaluate their operations when installed in your products.
- Install the following systems for a failsafe design to ensure safety if these products are to be used in equipment where a defect in these products may cause the loss of human life or other significant damage, such as damage to vehicles (automobile, train, vessel), traffic lights, medical equipment, aerospace equipment, electric heating appliances, combustion/gas equipment, rotating equipment, and disaster/crime prevention equipment.
- \* Systems equipped with a protection circuit and a protection device
- \* Systems equipped with a redundant circuit or other system to prevent an unsafe status in the event of a single fault

### (1) Precautions for use

- These products are designed and manufactured for general and standard use in general electronic equipment (e.g. AV equipment, home electric appliances, office equipment, information and communication equipment)
- These products are not intended for use in the following special conditions. Before using the products, carefully check the effects on their quality and performance, and determine whether or not they can be used.
  1. In liquid, such as water, oil, chemicals, or organic solvent
  2. In direct sunlight, outdoors, or in dust
  3. In salty air or air with a high concentration of corrosive gas, such as Cl<sub>2</sub>, H<sub>2</sub>S, NH<sub>3</sub>, SO<sub>2</sub>, or NO<sub>2</sub>
  4. Electric Static Discharge (ESD) Environment  
These components are sensitive to static electricity and can be damaged under static shock (ESD). Please take measures to avoid any of these environments.  
Smaller components are more sensitive to ESD environment.
  5. Electromagnetic Environment  
Avoid any environment where strong electromagnetic waves exist.
  6. In an environment where these products cause dew condensation
  7. Sealing or coating of these products or a printed circuit board on which these products are mounted, with resin or other materials
- These products generate Joule heat when energized. Carefully position these products so that their heat will not affect the other components.
- Carefully position these products so that their temperatures will not exceed the category temperature range due to the effects of neighboring heat-generating components. Do not mount or place heat-generating components or inflammables, such as vinyl-coated wires, near these products.
- Note that non-cleaning solder, halogen-based highly active flux, or water-soluble flux may deteriorate the performance or reliability of the products.
- Carefully select a flux cleaning agent for use after soldering. An unsuitable agent may deteriorate the performance or reliability. In particular, when using water or a water-soluble cleaning agent, be careful not to leave water residues. Otherwise, the insulation performance may be deteriorated.

### (2) Precautions for storage

The performance of these products, including the solderability, is guaranteed for a year from the date of arrival at your company, provided that they remain packed as they were when delivered and stored at a temperature of 5 °C to 35 °C and a relative humidity of 45 % to 85 %.

Even within the above guarantee periods, do not store these products in the following conditions. Otherwise, their electrical performance and/or solderability may be deteriorated, and the packaging materials (e.g. taping materials) may be deformed or deteriorated, resulting in mounting failures.

1. In salty air or in air with a high concentration of corrosive gas, such as Cl<sub>2</sub>, H<sub>2</sub>S, NH<sub>3</sub>, SO<sub>2</sub>, or NO<sub>2</sub>
2. In direct sunlight

### <Package markings>

Package markings include the product number, quantity, and country of origin. In principle, the country of origin should be indicated in English.

## Guidelines and precautions regarding the technical information and use of our products described in this online catalog.

- If you want to use our products described in this online catalog for applications requiring special qualities or reliability, or for applications where the failure or malfunction of the products may directly jeopardize human life or potentially cause personal injury (e.g. aircraft and aerospace equipment, traffic and transportation equipment, combustion equipment, medical equipment, accident prevention, anti-crime equipment, and/or safety equipment), it is necessary to verify whether the specifications of our products fit to such applications. Please ensure that you will ask and check with our inquiry desk as to whether the specifications of our products fit to such applications use before you use our products.
- The quality and performance of our products as described in this online catalog only apply to our products when used in isolation. Therefore, please ensure you evaluate and verify our products under the specific circumstances in which our products are assembled in your own products and in which our products will actually be used.
- If you use our products in equipment that requires a high degree of reliability, regardless of the application, it is recommended that you set up protection circuits and redundancy circuits in order to ensure safety of your equipment.
- The products and product specifications described in this online catalog are subject to change for improvement without prior notice. Therefore, please be sure to request and confirm the latest product specifications which explain the specifications of our products in detail, before you finalize the design of your applications, purchase, or use our products.
- The technical information in this online catalog provides examples of our products' typical operations and application circuits. We do not guarantee the non-infringement of third party's intellectual property rights and we do not grant any license, right, or interest in our intellectual property.
- If any of our products, product specifications and/or technical information in this online catalog is to be exported or provided to non-residents, the laws and regulations of the exporting country, especially with regard to security and export control, shall be observed.

## <Regarding the Certificate of Compliance with the EU RoHS Directive/REACH Regulations>



- The switchover date for compliance with the RoHS Directive/REACH Regulations varies depending on the part number or series of our products.
- When you use the inventory of our products for which it is unclear whether those products are compliant with the RoHS Directive/REACH Regulation, please select "Sales Inquiry" in the website inquiry form and contact us.

**We do not take any responsibility for the use of our products outside the scope of the specifications, descriptions, guidelines and precautions described in this online catalog.**

---

## Looking for pricing, stock, or lifecycle information?

Click below to explore more details on WIN SOURCE:

-  [View EXB-28V102JX on WIN SOURCE](#)
-  [Panasonic Information](#)

## Optimize Your Supply Chain with WIN SOURCE Solutions

-  Global Sourcing Solution
-  Obsolete Management
-  Cost Control Management
-  Shortage Management
-  Alternative Solution
-  Excess Inventory Management