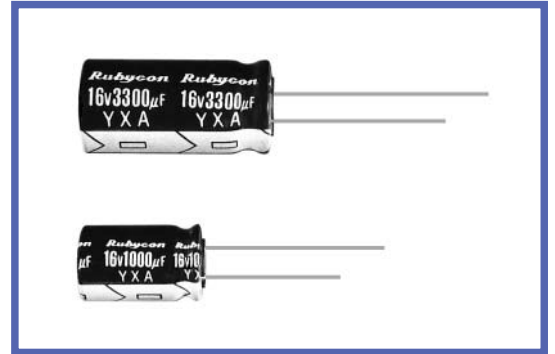

YXA SERIES
105°C Standard
◆FEATURES

- RoHS compliance.

◆SPECIFICATIONS

Items	特 性 Characteristics															
Category Temperature Range	-55~+105°C	-40~+105°C	-25~+105°C													
Rated Voltage Range	6.3~100V.DC	160~250V.DC	350~450V.DC													
Capacitance Tolerance	±20% (20°C, 120Hz)															
Leakage Current(MAX)	6.3~100V.DC		160~450V.DC													
	I=0.01CV or 3 µA whichever is greater. (After 2 minutes application of rated voltage)		CV ≤ 1000													
			CV > 1000													
		I=0.1CV+40 µA (1minute)	I=0.04CV+100 µA (1minute)													
		I=0.03CV+15 µA (5minutes)	I=0.02CV+25 µA (5minutes)													
I=Leakage Current(µA) C=Rated Capacitance(µF) V=Rated Voltage(V)																
(tanδ) Dissipation Factor(MAX)	Rated Voltage (V)												(20°C, 120Hz)			
	6.3	10	16	25	35	50	63	100	160	200	250	350		400	450	
		tan δ	0.26	0.22	0.18	0.16	0.14	0.12	0.10	0.08	0.20	0.20	0.20	0.24	0.24	0.24
When rated capacitance is over 1000 µF, tan δ shall be added 0.02 to the listed value with increase of every 1000 µF.																
Endurance	After life test with rated ripple current at conditions stated in the table below, the capacitors shall meet the following requirements.															
	Capacitance Change		Within ±25% of the initial value.											Case Size		Life Time (hrs)
	Dissipation Factor		Not more than 200% of the specified value.											φ D ≤ 8		1000
Leakage Current		Not more than the specified value.											φ D = 10		2000	
												φ D ≥ 12.5		3000		
Low Temperature Stability Impedance Ratio(MAX)	Rated Voltage (V)												(120Hz)			
	6.3	10	16	25	35	50	63	100	160	200	250	350		400	450	
	Z(-25°C)/Z(20°C)	4	3	2	2	2	2	2	2	3	3	3		6	6	6
		Z(-40°C)/Z(20°C)	8	6	4	4	3	3	3	3	-	-	-	-	-	

◆DIMENSIONS

(mm)

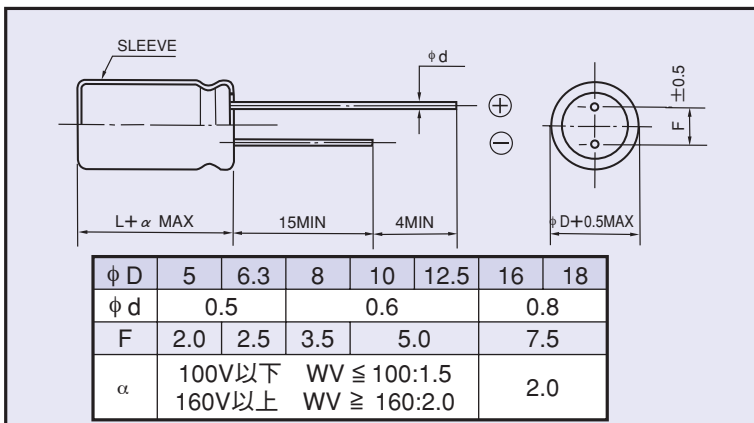
◆MULTIPLIER FOR RIPPLE CURRENT

Frequency coefficient

Frequency (Hz)		60(50)	120	500	1k	10k ≤
Coefficient	0.1~1 µF	0.50	1.00	1.20	1.30	1.50
	2.2~4.7 µF	0.65	1.00	1.20	1.30	1.50
	10~47 µF	0.80	1.00	1.20	1.30	1.50
	100~1000 µF	0.80	1.00	1.10	1.15	1.20
	2200~22000 µF	0.80	1.00	1.05	1.10	1.15

◆PART NUMBER

□□□	YXA	□□□□□	□	□□□	□□	DXL
Rated Voltage	Series	Rated Capacitance	Capacitance Tolerance	Option	Lead Forming	Case Size

Looking for pricing, stock, or lifecycle information?

Click below to explore more details on WIN SOURCE:

- [View 10YXA2200MEFC10X20 on WIN SOURCE](#)
- [Rubycon Information](#)

Optimize Your Supply Chain with WIN SOURCE Solutions

- ✓ Global Sourcing Solution
- ✓ Obsolete Management
- ✓ Cost Control Management
- ✓ Shortage Management
- ✓ Alternative Solution
- ✓ Excess Inventory Management