

### ◆ General Description

GH1200 series unipolar switch Hall position sensor is designed with CMOS technology.

The input control signal is magnetic induction intensity, output is a switch type digital voltage signal, suitable for working with rectangular or cylindrical magnets. When there is no magnetic field control, the output tube of the sensor circuit in this series will be turned off and the output will be at a high level; When the magnetic field strength  $B$  is greater than the operating point (BOP), the output switch tube will open and the output will be at a low level; The output state will remain until the magnetic field strength  $B$  is lower than the release point (BRP), at which point the output switch will turn off and the output will return to a high level..

### ◆ Features

- 2.8~ 24V DC Operation Voltage
- CMOS Technology
- Open drain output structure, able to directly interface with logic circuits
- 25mA Output Sink Current
- Operating Temp: -40~ +125°C
- Package: TO-92S/ SOT23-3L/ SOT23
- Lead Free Finish/RoHS Compliant

### ◆ Applications

- DC brushless motor
- Contactless switch
- Position control
- Isolation testing
- Speed detection

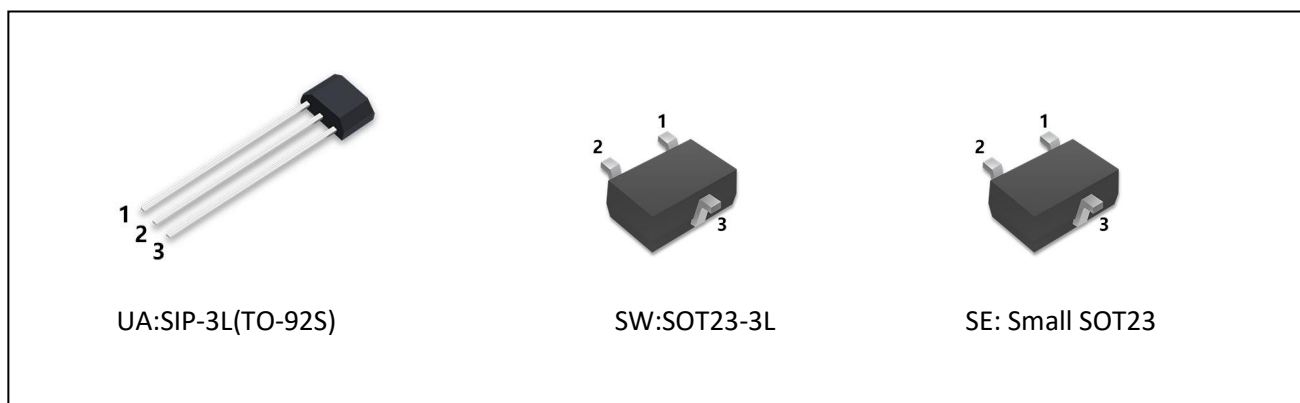

Figure 1. Package Type

## ◆ Ordering information

Product	Temp	Package	Magnetic	Packing Type	Quantity
GH1210KUA	K	UA	South pole	Pack	1000pic
GH1210KSW	K	SW	North pole	Tape & Reel	3000pic
GH1220KUA	K	UA	South pole	Pack	1000pic
GH1220KSW	K	SW	North pole	Tape & Reel	3000pic
GH1220KSE	K	SE	South pole	Tape & Reel	3000pic
GH1230KUA	K	UA	South pole	Pack	1000pic
GH1230KSW	K	SW	North pole	Tape & Reel	3000pic

## Note

- 1) K stands for temp range -40~125°C
- 2) UA represents the packaging form SIP-3L/TO-92S
- 3) SW represents the packaging form SOT23-3L
- 4) SE represents the packaging form as small SOT23

## ◆ Pin Configuration

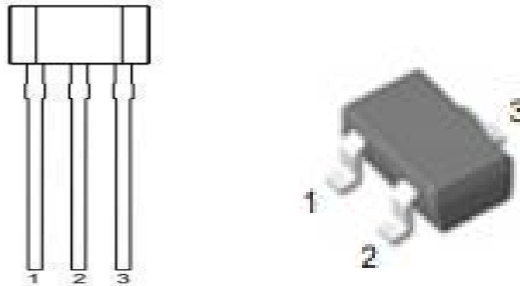

Pin Number		Pin Name	Function
SIP-3L	SOT23-3L/SOT23		
1	1	VCC	Power supply
2	3	GND	Ground
3	2	VOUT	Output

## ◆ Functional Block Diagram

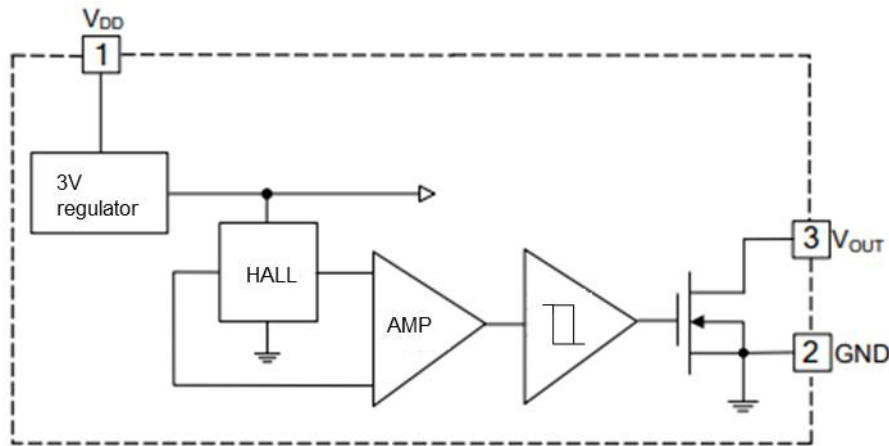

**Figure 2. Block Diagram**

## ◆ Absolute Maximum Ratings

Parameter	Symbol	Value	Unit
Supply Voltage	$V_{CC}$	-0.3~+28	V
Output Off Voltage	$V_{OUT}$	+32	V
Output Current	$I_{OUT}$	50	mA
Operation Temperature	$T_A$	-40~+150	°C
Storage Temperature	$T_{ST}$	-65~+160	°C
Flux	B	unlimit	Guass

## ◆ Electrical Characteristics

$V_{DD}=12V$ ,  $T_A=25^{\circ}C$ , unless otherwise specified.

Parameter	Symbol	Condition	Min	Typ	Max	Unit
Supply Voltage	$V_{CC}$	Operating	2.8	12	24	V
Supply Current	$I_{CC}$	-	--	2.0	5.0	mA
Output low-level voltage	$V_{OUTL}$	$I_{OUT}=20mA$ , $B>BOP$	--	200	500	mV
Output high-level leakage current	$I_{off}$	$V_{OUT}=24V$ , $B < BRP$	--	<0.1	10	$\mu A$
Maximum switching frequency	$F_{sw}$	$R_L=820\Omega$ , $C_L=20pF$	--	10	--	KHz
Output Fall/Up Time	$t_f/t_r$	$R_L=820\Omega$ , $C_L=20pF$	--	0.1	0.5	us

Note:

- 1) If any one of the maximum ratings is exceeded, the device may be damaged.
- 2) The maximum power supply voltage that can work normally must be adjusted according to the constraints of temperature and power consumption.

## ◆ Magnetic Characteristics

( $V_s=12V, T_A=25^{\circ}C$ )

### GH1210KUA (for South pole)

Parameter	Symbol	Condition	Min	Typ	Max	Unit
Operate Point	BOP	VCC=12V,TA=25°C	25	45	65	GS
Release Point	BRP	VCC=12V,TA=25°C	10	30	50	GS
Hysteresis	BHYS	VCC=12V,TA=25°C	5	15	25	GS

### GH1210KSW (for North pole)

Parameter	Symbol	Condition	Min	Typ	Max	Unit
Operate Point	BOP	VCC=12V,TA=25°C	-65	-45	-25	GS
Release Point	BRP	VCC=12V,TA=25°C	-50	-30	-10	GS
Hysteresis	BHYS	VCC=12V,TA=25°C	5	15	25	GS

### GH1220KUA/GH1220KSE (for South pole)

Parameter	Symbol	Condition	Min	Typ	Max	Unit
Operate Point	BOP	VCC=12V,TA=25°C	100	120	140	GS
Release Point	BRP	VCC=12V,TA=25°C	70	90	110	GS
Hysteresis	BHYS	VCC=12V,TA=25°C	10	30	50	GS

### GH1230KUA (for South pole)

Parameter	Symbol	Condition	Min	Typ	Max	Unit
Operate Point	BOP	VCC=12V,TA=25°C	15	30	45	GS
Release Point	BRP	VCC=12V,TA=25°C	10	20	30	GS
Hysteresis	BHYS	VCC=12V,TA=25°C	5	10	15	GS

### GH1230KSW (for North pole)

Parameter	Symbol	Condition	Min	Typ	Max	Unit
Operate Point	BOP	VCC=12V,TA=25°C	-45	-35	-15	GS
Release Point	BRP	VCC=12V,TA=25°C	-30	-20	-10	GS
Hysteresis	BHYS	VCC=12V,TA=25°C	5	10	15	GS

Note: 1mT=10Gs

## ◆ Functional Description

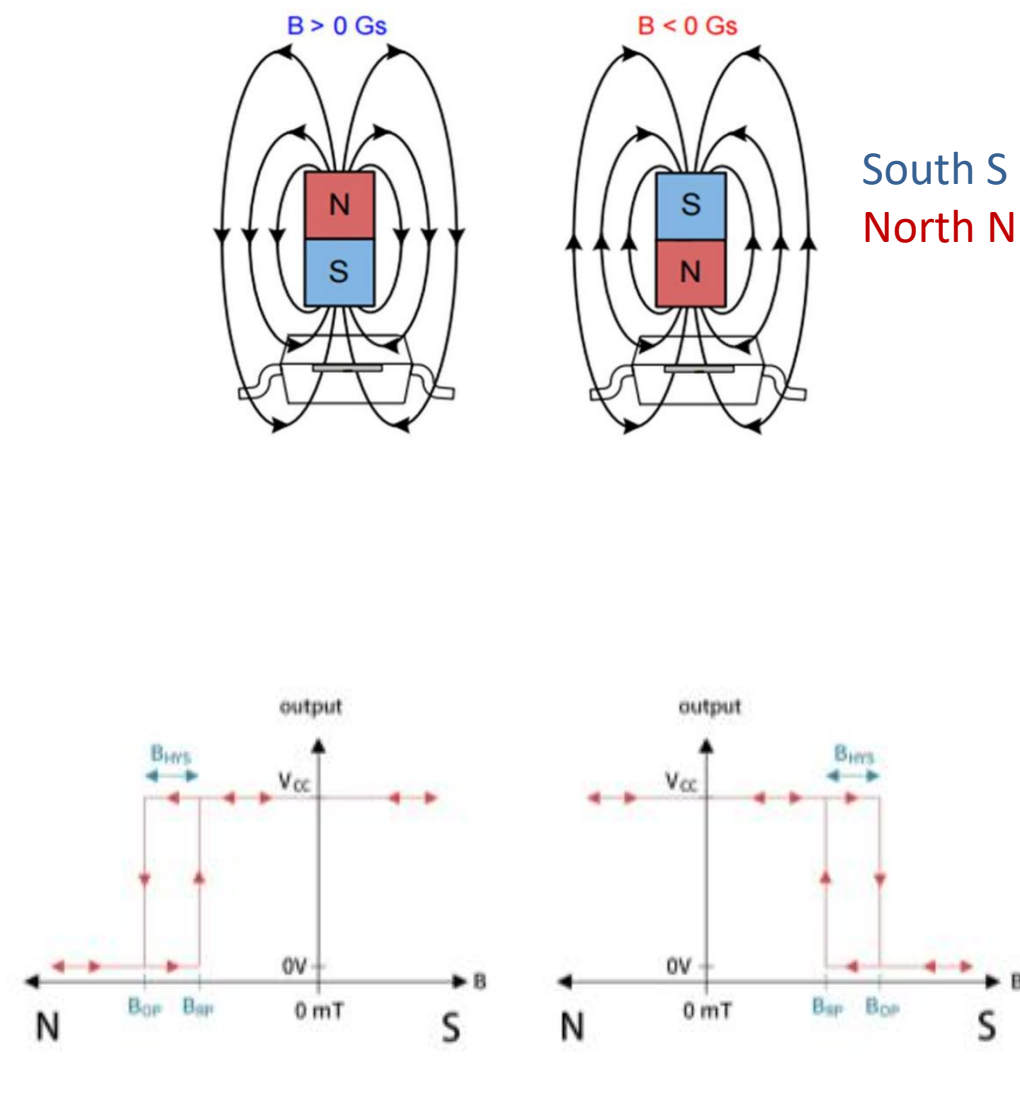

Figure 3. Output characteristics

## ◆ Typical Application

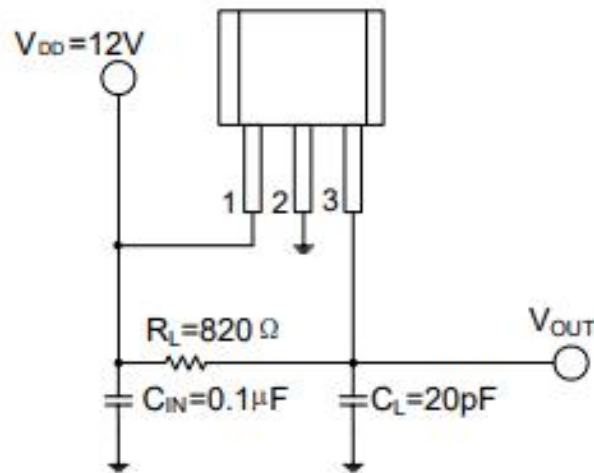

Figure 4. Application

Note:

$C_{IN}$  is used to stabilize external power supply;

$R_L$  is the pull-up resistance necessary for open collector output;

$C_L$  is used for filter out the output noise. This capacitor will affect the rise time of the waveform.

## ◆ Marking Information

1) TO-92S package

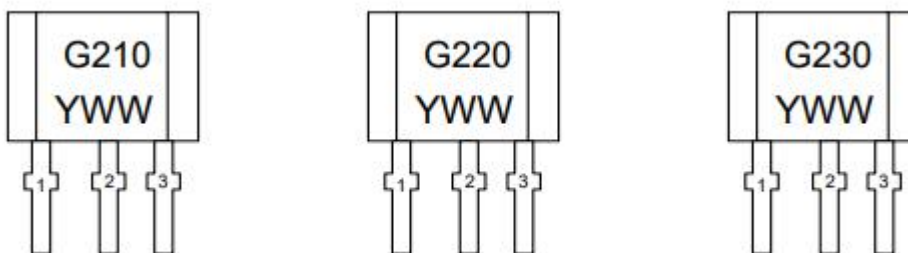

G210, G220, G230: for GH1210, GH1220, GH1230

Y: YEAR: "4" = 2024

WW: Nth Week 01~52

# GH1210/1220/1230

Unipolar switch Hall position sensor

2) SOT23-3L/ SOT23 package

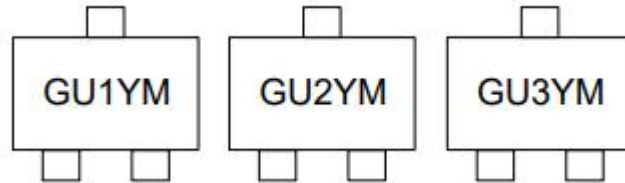

GU1, GU2, GU3: for GH1210, GH1220, GH1230

Y: YEAR: "4" = 2024

M: Nth Month, A~L

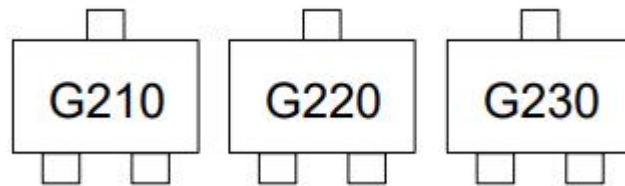

G210, G220, G230: for GH1210, GH1220, GH1230

## ◆ Package Information

### (1) SIP-3L(TO-92S)

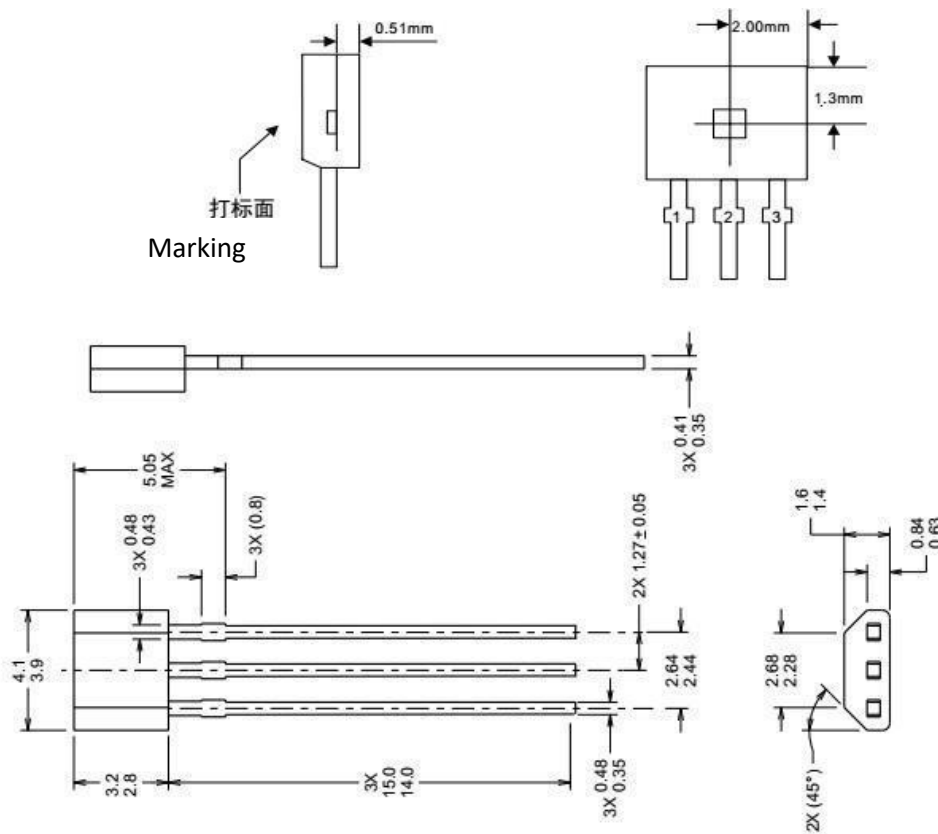

### (2) SOT23-3L

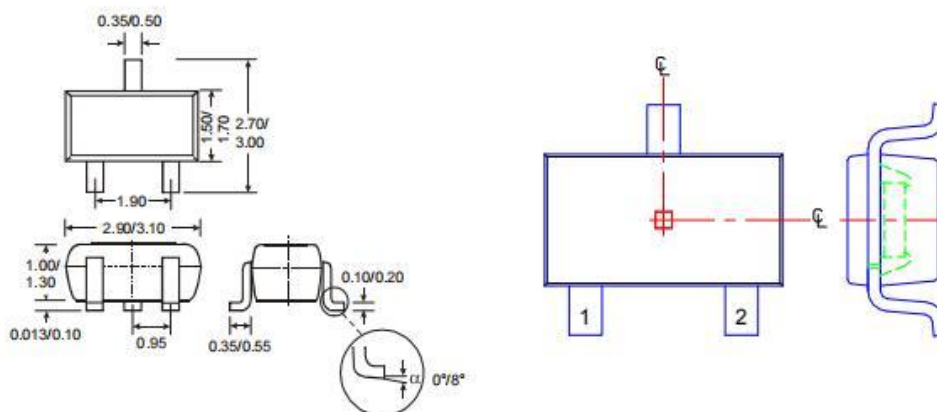

# GH1210/1220/1230

Unipolar switch Hall position sensor



(3) SOT23 (Small)

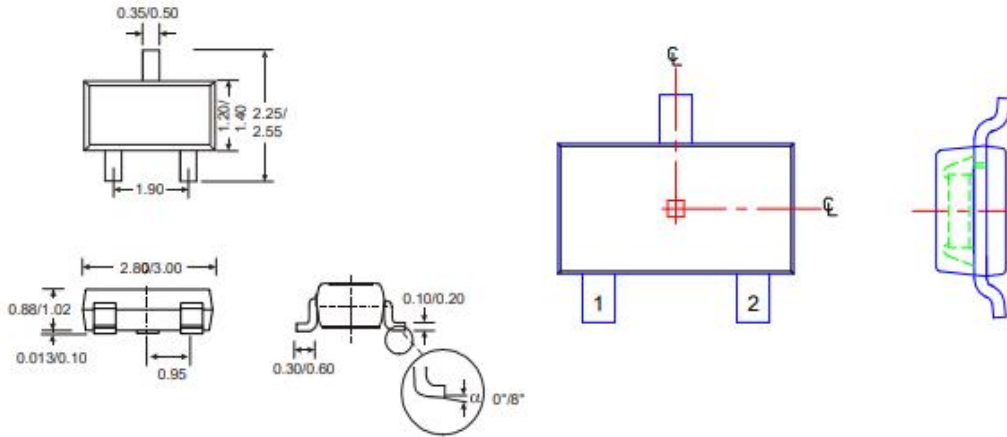

### ◆ Copyright and Other Disclaimers

GoChip Microelectronics reserves the right to modify the product and its specifications in order to provide customers with better products. If there are any changes to the specifications, no further notice will be given. Please confirm the latest information with the sales department of GoChip Microelectronics before purchasing the products specified in this specification sheet.

GoChip Microelectronics has always been committed to improving the quality and reliability of its products. However, any semiconductor product has a certain possibility of failure or malfunction under specific conditions. Customers have the responsibility to strictly follow the requirements of the corresponding specification book when using GoChip Microelectronics products for product development, and to comply with safety standards and take safety measures during system design and whole machine manufacturing to avoid potential failure risks, personal injury or property damage. If personal injury or property damage is caused by customers' improper use of GoChip Microelectronics products, GoChip Microelectronics shall not be held responsible.

This product is mainly used in consumer, industrial, and automotive electronic products. If customers apply this product to fields such as chemistry, medical, military, aerospace, etc. that require extremely high quality and reliability, GoChip Microelectronics will not be held responsible for any personal injury or property damage caused by potential failure risks.

The information contained in this specification is only intended as a guide for the application of this product and does not imply any patent or intellectual property license. GoChip Microelectronics shall not be liable for any infringement of third-party patents and intellectual property rights by the customer.

Shanghai GoChip Microelectronics Co., Ltd. has released in China, all rights reserved. The company name and logo of Shanghai GoChip Microelectronics Co., Ltd. are trademarks or registered trademarks of Shanghai GoChip Microelectronics Co., Ltd. in China.

### ◆ About GoChip

GoChip Microelectronics is a Chinese high-tech company, dedicating in the R&D, sales, and technical services of sensor chips. It was founded in 2010 and Headquarter in Shanghai, China. Now we have two R&D centers in both Shanghai and Hangzhou city, as well as marketing service networks throughout the country.

Taking the core concept of "Enhance oneself and Surpass expectations", and with more than a decade of persistent technological innovation and high-quality services, GoChip has gradually established a business mode with automotive electronics as the main track and continuously developing in the fields of new energy, industrial automation, consumer electronics. In automotive electronics, we are committed to providing customers with high-performance and reliable sensor chip solutions. Our products are widely used in automotive chassis control systems, engine power systems, and intelligent cabin electric systems. GoChip will continue to increase investment in technological R&D, actively explore the development and promotion of new products, and strive to make greater contributions to China Chip.

#### Shanghai headquarters

Room 301-302, Building B, L'Oreal Business Center, No. 8923 Zhongchun Road, Minhang District, Shanghai

Phone: +86-21-34140399

Website: [www.golden-chip.com/](http://www.golden-chip.com/)

E-Mail: [sales@golden-chip.com.cn](mailto:sales@golden-chip.com.cn)

#### R&D Center

Shanghai Zhangjiang R&D Center, Hangzhou R&D Center

#### South China Marketing Center

Room 350, Zhongchuang Business Center, Yusheng Huating, 8210 Bao'an Avenue, Shenzhen



## Looking for pricing, stock, or lifecycle information?

Click below to explore more details on WIN SOURCE:

 [View GH1210KUA on WIN SOURCE](#)

 [GoChip Information](#)

## Optimize Your Supply Chain with WIN SOURCE Solutions

-  Global Sourcing Solution
-  Obsolete Management
-  Cost Control Management
-  Shortage Management
-  Alternative Solution
-  Excess Inventory Management