

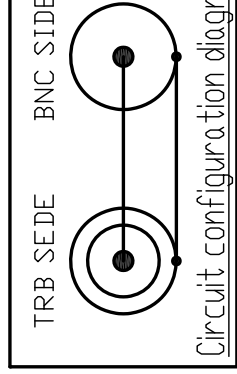

THE DATASHEET OF TRBP1-BNCJ

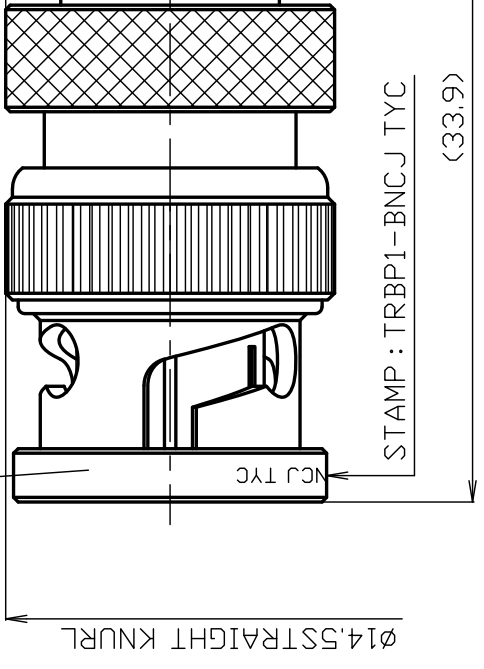

1 2 3 4 5 6 7 8 9 10

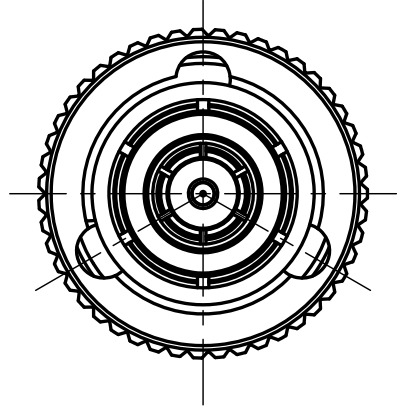

* PHOSPHOR BRONZE

12	BUSHING	BRASS	1	Ni
11	INSULATOR B	PTFE	1	--
10	BODY	BRASS	1	Ni
9	CENTER PIN	*	1	Au
8	FLAT WASHER	FE	1	Ni
7	WAVE WASHER	SK5	2	Ni
6	HALF FLAT WASHER	BRASS	2	Ni
5	GASKET	SILICONE	1	--
4	INSULATOR A	PTFE	1	--
3	OUTER CONTACT	BRASS	1	--
2	INSULATOR C	PTFE	1	Au
1	SHELL	BRASS	1	Ni
NO.	DESCRIPTION	MATERIAL	Q'TY	FINISH
				REMARK

SCALE 3/1
UNIT mm
DATE 2024.05.20

DRAWN	INSPECTED	APPROVED
上領	檜澤	'24.05.20
'24.05.20	'24.05.20	'24.05.20
PROJECTION		株式会社 70-

PRODUCT SPECIFICATIONS





Part number: TRBP1-BNCJ No. 0642689
 Drawing number: K-1046476
 Nominal 1 Standard MIL-C-39012(BNC)
 MIL-PRF-49142(TRB)
 2 Voltage rating AC 500V
 3 Impedance Mismatch
 4 Operating tempure range -40°C~+85°C
 5 Operating humidity range 95%(Max.) ※No condensation



	Test Items	Test Method/Value	Remarks
1	E L E C T R I C A L	Insulation resistance	1000MΩ(Min.) at DC 250V
2		Withstanding voltage	1 minute at AC 500V
3		Contact resistance	Inner conductor : 3mΩ(Max.) Intermediate conductor : 0.5mΩ (Max.)(TRB) Outer conductor : 1mΩ(Max.)(TRB) Outer conductor : 3mΩ(Max.)(BNC)
4	M E C H A N I C A L	Compatibility	No defects or abnormalities Connecting with a standard-compliant connector
5		Tensile strength of coupling mechanism	250N(BNC) 444.82N(TRB) At axial tensile force
6		Center contact retaining force	1N(Min.)(BNC) With a standard pin gauge
	O T H E R S		

※The structural shape is shown in the attached drawing (Drawing number:K-1046476)



	REVISIONS	DATE
1		
2		
3		

Checked	Approved	Inspected	Prepared
			

GKQM-24

Looking for pricing, stock, or lifecycle information?

Click below to explore more details on WIN SOURCE:

-  [View TRBP1-BNCJ on WIN SOURCE](#)
-  [TYCLON Information](#)

Optimize Your Supply Chain with WIN SOURCE Solutions

-  Global Sourcing Solution
-  Obsolete Management
-  Cost Control Management
-  Shortage Management
-  Alternative Solution
-  Excess Inventory Management