



**THE DATASHEET OF
NPJ50AT6G20W-10DB**



7 6 5 4 3 2 1

STAMP : 20W TYC 10dB IN

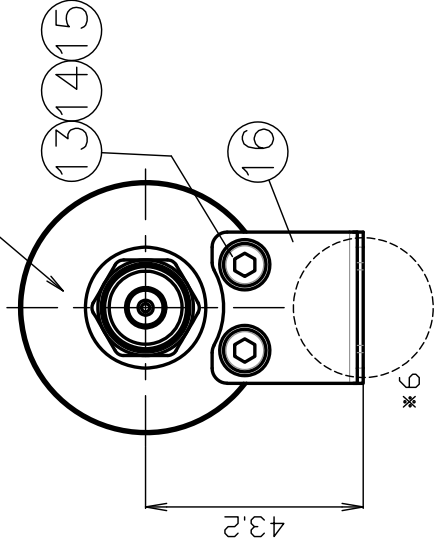

8 9

(92)

STAMP : SERIAL

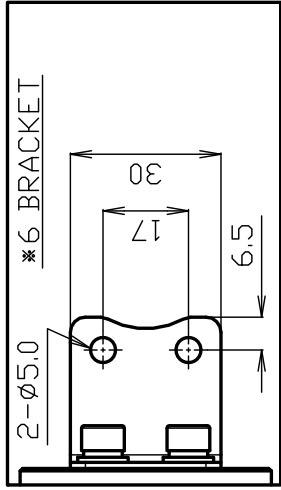
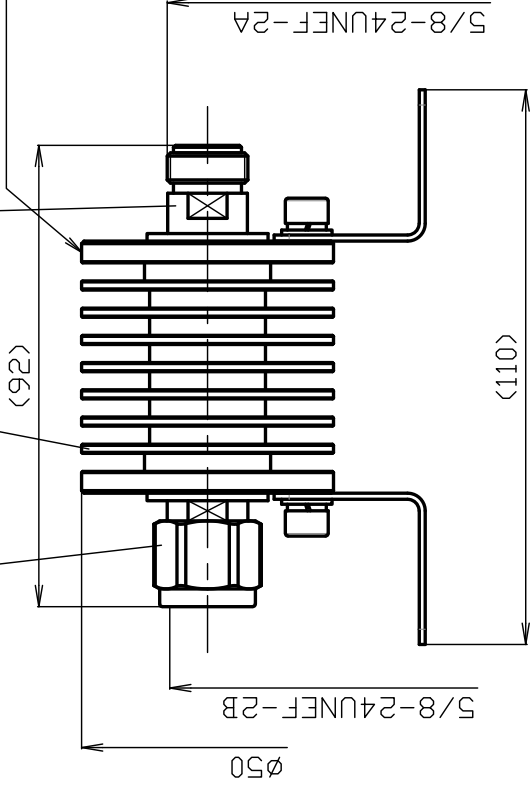

- * 1 : TERNARY PLATING
- * 2 : ANODAIZING(BLACK)
- * 3 : PASSIVATE
- * 4 : STAINLESS STEEL
- * 5 : PHOSPHOR BRONZE

12	INSULATOR B	PTFE	1	--		16	BRACKET	* 4
11	CENTER PIN B	* 5	1	Au		15	WASHER	* 4
10	BODY B	BRASS	1	* 1		14	SPRING WASHER	* 4
9	ATTENUATION TERMINAL	--	1	--		13	SOCKET HEAD CAP SCREW	* 4
8	HEAT SINK	ALUMINUM	1	* 2		ND.	DESCRIPTION	MATERIAL
7	O-RING	SILICONE	2	--		SCALE	2 / 3	
6	INSULATOR A	PTFE	1	--		DRAWN		INSPECTED
5	CENTER PIN A	* 5	1	Au				APPR
4	GASKET	SILICONE	1	--				
3	BODY A	BRASS	1	* 1		UNIT		
2	HOLDING RING	* 4	1	--		DATE	2023.12.18	
1	COUPLING NUT	BRASS	1	* 1		REMARK		
ND.	DESCRIPTION	MATERIAL	Q'TY	FINISH				

井出
'23.12.18

樽澤
'23.12.18

PROJECTION

株式会社 70-

PRODUCT SPECIFICATIONS

Part No. NPJ50AT6G20W-10dB

No. 0592344





DWG No. W-0595943

Nominal 1 Standard JIS C 5411
 2 Power handling 20W
 3 Frequency range 6GHz
 4 Impedance 50Ω
 5 [OPR]Temp-Range -45°C~+85°C





		Test Items	Procedures/Test method	Requirements
1 2 3	DESIGN	Design & construction	Specified on relevant product drawing (DWG No. W-0595943)	No defects or abnormalities
		Materials		
		Finishes		
4 5	ELECTRICAL	Attenuation	DC~6GHz	10±0.8dB
		V. S. W. R	DC~3GHz	1.2 (Max.)
			3~6GHz	1.3 (Max.)
6 7 8	MECHANICAL	Compatibility	Connecting with a standard-compliant connector	No defects or abnormalities
		Tensile strength of coupling mechanism	At axial tensile force 300N	No defects or abnormalities
		Connection nut tightening torque	0.9~1.7N·m	No defects or abnormalities
9	ENVIRONMENTAL	Waterproof	IPX7	No water ingress inside the connector

	Remarks	Date
1		
2		
3		

Checked	Approved	Inspected	Prepared
 三村 21.11.22	 山本 21.11.22	 檀澤 21.11.22	 渡邊直弘 21.11.22

Looking for pricing, stock, or lifecycle information?

Click below to explore more details on WIN SOURCE:

-  [View NPJ50AT6G20W-10dB on WIN SOURCE](#)
-  [TYCLON Information](#)

Optimize Your Supply Chain with WIN SOURCE Solutions

-  Global Sourcing Solution
-  Obsolete Management
-  Cost Control Management
-  Shortage Management
-  Alternative Solution
-  Excess Inventory Management