

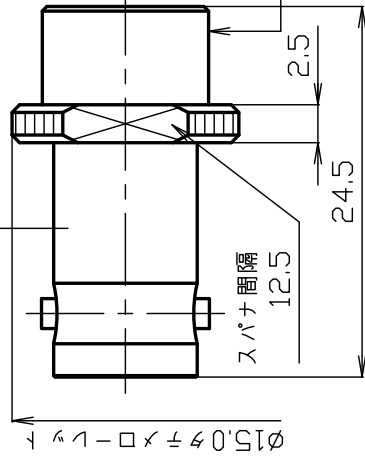

THE DATASHEET OF BNCJ-58/U



128



刻印
BNC-J-58/U TYC

3

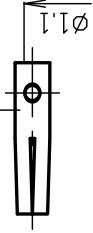

4

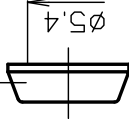

5

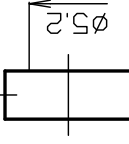

RECOMMENDED CABLE STRIPPING DIMENSIONS

1

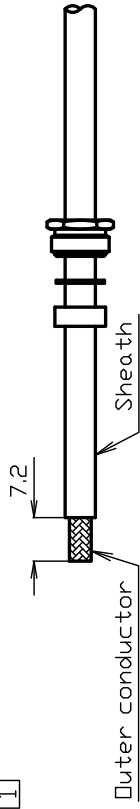

2

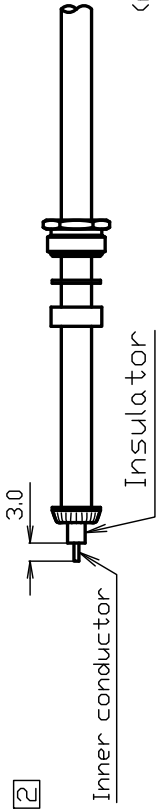

8	ブッシュング	黄銅	1	Ni
7	締付ナット	黄銅	1	Ni
6	ワッシャー	黄銅	1	Ni
5	ガスケット	シリコングム	1	--
4	クラック	黄銅	1	Ni
3	中心コンタクト	リン青銅	1	Au
2	シエール	黄銅	1	Ni
1	絶縁体	テフロン	1	--
番号	部品名	材質	数量	処理
			備考	

尺度 2/1

単位 mm

日付 97.03.06

製図	上領	'23.12.12
検図	樽澤	'23.12.12
承認		
承認		

投影法



株式会社 70-

PRODUCT SPECIFICATIONS

Part No. BNCJ-58/U

No. 0310300

DWG No. Y-0320806





Nominal 1 Standard
 2 Voltage rating
 3 Frequency range
 4 Impedance

JIS C 5412
 AC 500V
 4GHz
 50Ω



Test Items		Procedures/Test method	Requirements
DESIGN	1 Design & construction	Specified on relevant product drawing (DWG No. Y-0320806)	No defects or abnormalities
	2 Materials		
	3 Finishes		
ELECTRICAL	4 Insulation Resistance	DC 500V	1000MΩ (Min.)
	5 Withstanding voltage	AC 1500V (1 minute.)	No defects or abnormalities
	6 Contact resistance	The method of which, the voltage drop of the contact duration should not exceed 1-kHz AC or 1mV DC	3mΩ (Max.)
	7 V. S. W. R	DC~1GHz	1.2 (Max.)
MECHANICAL	8 Compatibility	Connecting with a standard-compliant connector	No defects or abnormalities
	9 Center contact retaining force	When using the standard pin gauge 0.98N (Min.)	No defects or abnormalities
	10 Cable tensile strength	At axial tensile force 98N (Min.)	No defects or abnormalities
	11 Tensile strength of coupling mechanism	At axial tensile force 245N	No defects or abnormalities
12	Cable group	RG-58/U、RG-58A/U	

Remarks	Date
1	
2	
3	

Checked	Approved	Inspected	Prepared
 三 18.06.05 村	 山 18.06.05 本	 檜 18.06.05 澤	 渡邊 18.06.05 直弘

GKQM-25

Looking for pricing, stock, or lifecycle information?

Click below to explore more details on WIN SOURCE:

 [View BNCJ-58/U on WIN SOURCE](#)

 [TYCLON Information](#)

Optimize Your Supply Chain with WIN SOURCE Solutions

-  Global Sourcing Solution
-  Obsolete Management
-  Cost Control Management
-  Shortage Management
-  Alternative Solution
-  Excess Inventory Management