



**THE DATASHEET OF  
EVN-5ESX50B52**



### 3 mm Square SMT Trimmer Potentiometers (Carbon Composition, Dustproof Type)

Type: **EVN5E**(with rotation stopper)  
**EVN5C**



#### ■ Features

- No readjustment needed through Rotor protected Structure for careless slip
- Excellent mounting efficiency due to cubic shape suited to automatic pick-and-place assembly equipment
- Excellent reliability through dustproof Structure
- Rotation stopper featured type (EVN5E□)
- Conforms to JIS C5260-1:1999

#### ■ Recommended Applications

- Audio/visual, office, and communication equipment
- General electronic equipment

#### ■ Explanation of Part Numbers

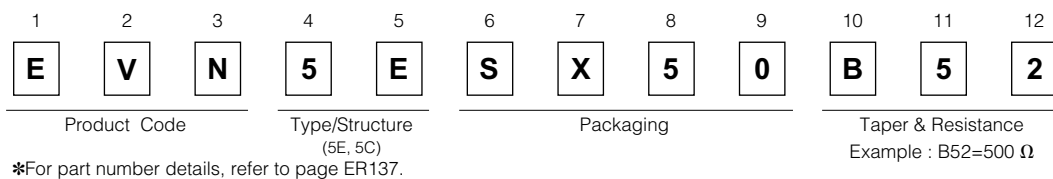

#### ■ Specifications

Total Resistance Value Resistance Tolerance	200 Ω to 1 MΩ ±30 %
Power Rating Maximum Operating Voltage	0.05 W (50 °C) 50 V
Rotation Torque	1 to 15 mN·m
Stopper Strength	20 mN·m (Stopper featured type)
Temperature Coefficient of Resistance	±500 × 10 <sup>-6</sup> /°C (25 to 85 °C) ±750 × 10 <sup>-6</sup> /°C (-25 to +25 °C)

#### ■ Minimum Quantity/Packing Unit

Part Number	Taping		
	Quantity per reel	Packaging quantity	Dia. of reel (mm)
EVN5E EVN5C	2000	10000	φ178

The standard packaging methods for a reel is φ178.  
Please contact us, if you would like different packaging methods. (Bulk, Reel of φ330, Reel of φ380)

#### ■ Dimensions in mm (not to scale)

- 3-terminal, Rotation stopper featured type ..... EVN5E
- 3-terminal ..... EVN5C

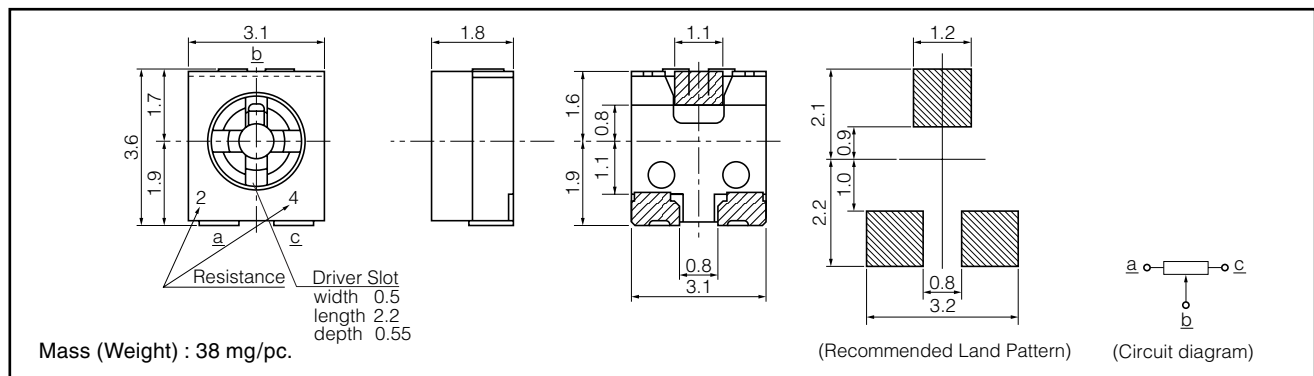

### ■ Explanation of Part Numbers

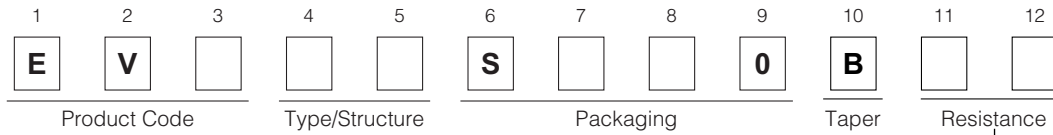

6th	7th	Packaging
S	X	Carrier tape (7th: Direction of insertion. Refer to Packaging Specifications)
	W	

\* The standard of direction of insertion is a direction X.  
EVM2T/2N type be only direction X.

8th	Quantity	Type
3	1000	EVM1D, EVM1E, EVM1U
5	2000	EVM3Y, EVM3S, EVM3R, EVM3V, EVN5E, EVN5C
8	3000	EVM2T, EVM2N, EVM2W, EVM3W

Classification	Type	Symbol(1th to 5th)
Cermet	2 mm Open	EVM2T, EVM2N, EVM2W (low-profile)
	3 mm Open	EVM3Y, EVM3S EVM3R, EVM3W(low-profile) EVM3V(with rotation stopper)
	4 mm Open	EVM1D, EVM1E EVM1U
Carbon	3 mm Dustproof	EVN5E(with rotation stopper) EVN5C

Symbol	Resistance	EVM2T EVM2N EVM2W EVM3Y EVM3S EVM3W EVM3V EVM1D EVM1E EVM1U	EVM3R	EVN5E EVN5C
12	100 Ω	○	—	—
C2	150 Ω	○	—	—
22	200 Ω	○	—	○
E2	220 Ω	○	—	○
32	300 Ω	○	—	○
Y2	330 Ω	○	—	○
Q2	470 Ω	○	—	○
52	500 Ω	○	○	○
S2	680 Ω	○	○	○
13	1 kΩ	○	○	○
C3	1.5 kΩ	○	○	○
23	2 kΩ	○	○	○
E3	2.2 kΩ	○	○	○
33	3 kΩ	○	○	○
Y3	3.3 kΩ	○	○	○
Q3	4.7 kΩ	○	○	○
53	5 kΩ	○	○	○
S3	6.8 kΩ	○	○	○
14	10 kΩ	○	○	○
C4	15 kΩ	○	○	○
24	20 kΩ	○	○	○
E4	22 kΩ	○	○	○
34	30 kΩ	○	○	○
Y4	33 kΩ	○	○	○
Q4	47 kΩ	○	○	○
54	50 kΩ	○	○	○
S4	68 kΩ	○	○	○
15	100 kΩ	○	○	○
C5	150 kΩ	○	○	○
25	200 kΩ	○	○	○
E5	220 kΩ	○	○	○
35	300 kΩ	○	○	○
Y5	330 kΩ	○	○	○
Q5	470 kΩ	○	○	○
55	500 kΩ	○	○	○
S5	680 kΩ	○	○	○
16	1 MΩ	○	○	○

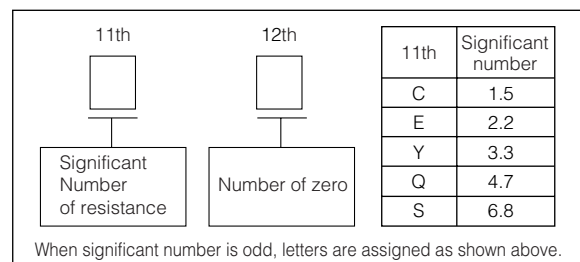

## Alternative products

### 【3mm Square SMT Trimmer Potentiometers】

Production discontinuance Parts No.	Type
EVN5ESX50B**	Carbon 3mm Square Dustproof (with the rotation stopper)
EVN5CSX50B**	Carbon 3mm Square Dustproof

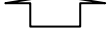

Recommended substitution Parts No.	
EVM3V SX50B**	Cermet 3 (with the rotation stopper)
EVM3Y SX50B**	Cermet 3

### 【6mm Square Dustproof Ceramic Trimmer Potentiometers】

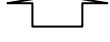

Production discontinuance Parts No.	Type
EVMEASA00B**	Cermet 6mm Square Dustproof (Radial taping, with Knob Protection)
EVMEAGA00B**	Cermet 6mm Square Dustproof (Bulk, with Knob Protection)
EVMEESA00B**	Cermet 6mm Square Dustproof (Radial taping, with Knob Protection)
EVMEEGA00B**	Cermet 6mm Square Dustproof (Bulk, with Knob Protection)



Recommended substitution Parts No.	
EVMASA00B**	Cermet 6 (Radial taping)
EVMAAGA00B**	Cermet 6 (Bulk)
EVMAESA00B**	Cermet 6 (Radial taping)
EVMAEGA00B**	Cermet 6 (Bulk)

## Looking for pricing, stock, or lifecycle information?

Click below to explore more details on WIN SOURCE:

-  [View EVN-5ESX50B52 on WIN SOURCE](#)
-  [Panasonic Information](#)

## Optimize Your Supply Chain with WIN SOURCE Solutions

-  Global Sourcing Solution
-  Obsolete Management
-  Cost Control Management
-  Shortage Management
-  Alternative Solution
-  Excess Inventory Management