



THE DATASHEET OF
61031221121



1

2

3

4

5

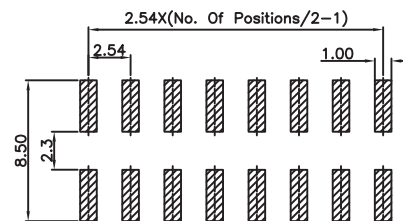

PCB LAYOUT - COMPONENT VIEW

TECHNICAL CHARACTERISTICS

MATERIAL
 INSULATOR: PA 6T
 FLAMMABILITY RATING: UL94-V0
 COLOR: BLACK
 CONTACT MATERIAL: COPPER ALLOY
 CONTACT TYPE: STAMPED
 CONTACT PLATING: GOLD
 QUALITY CLASS: 3 AS PER CECC 75 301-802
 PITCH: 2.54 MM

ENVIRONMENTAL

OPERATING TEMPERATURE: -40 UP TO 125°C
 COMPLIANCE: LEAD FREE AND ROHS

ELECTRICAL

CURRENT RATING: 3A
 WORKING VOLTAGE: 250 VAC
 INSULATOR RESISTANCE: >1000 MOHM
 DIELECTRIC WITHSTANDING VOLTAGE: 500 VAC/MN
 CONTACT RESISTANCE: 20 mOHM MAX

STANDARD

 CERTIFIED: E323964

SOLDERING

JEDEC LEAD FREE REFLOW SOLDERING

PACKAGING

TAPE & REEL WITH CAP



DIMENSION

A = 2.54x (NB. PIN / 2 - 1)

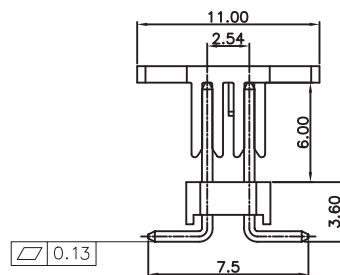
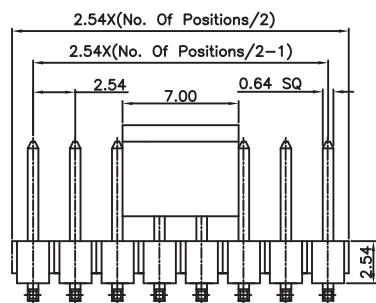
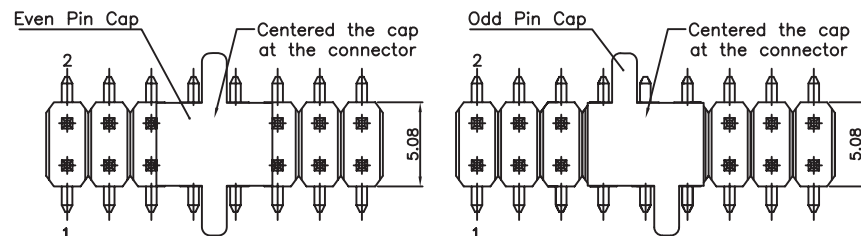
B = 2.54x (NB. PIN / 2)

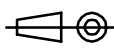

RoHS Compliant

REV	DATE	FILE	BY	PROJECTION:	GENERAL TOLERANCE	DESCRIPTION: 2.54MM DUAL SMT PIN HEADER	SIZE
G					.X = +/- 0.2 .XX = +/- 0.15		A4
F	10-JAN-17	UPDATE	AK				
E	04-MAR-13	DRAWING	QL				
D	29-JUL-09	PACKAGING	JP				
C	09-NOV-07	PAGE 2	CH	APPROVAL: GMo	UNIT: MM	DESCRIPTION: 2.54MM DUAL SMT PIN HEADER	A4
B	25-OCT-07	PAD SIZE	EC		SCALE:	WERI PART NO: 610 3xx 211 21	
A	29-DEC-06	PDF	JP		SHEET: 1/3		
REV	DATE	FILE	BY		DRAW: MARY		

1

2

3

4

5

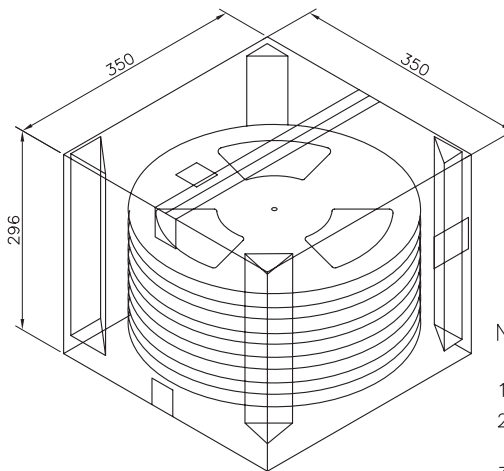
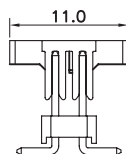
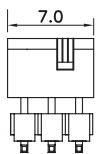
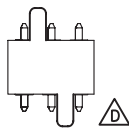

Note:

- 1.All dimensions meet EIA-481-3 requirements.
- 2.Material : Black Conductive Polystyrene Alloy
100% recyclable.
- 3.Thickness : 0.50±0.05mm
- 4.Component load per 13" reel :300 pcs.
- 5.Carton Size:350*350*296(MM)
- 6.W ≤ 24, Single Row Hole.
W > 24, Double Rows Hole
- 7.Apply to Product:
2213SM-XXX-BK-CR,2213SM-XXX-CR
2213SM-XXG30-CR

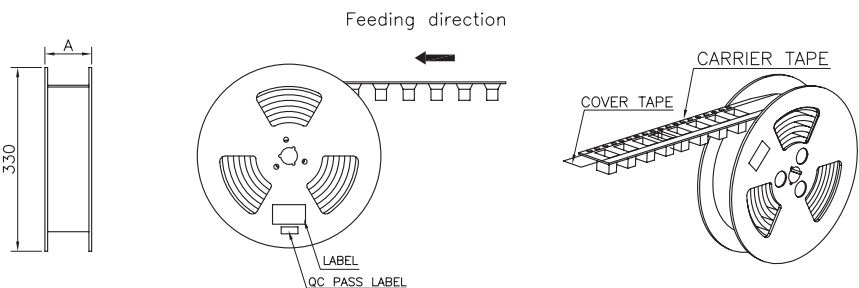
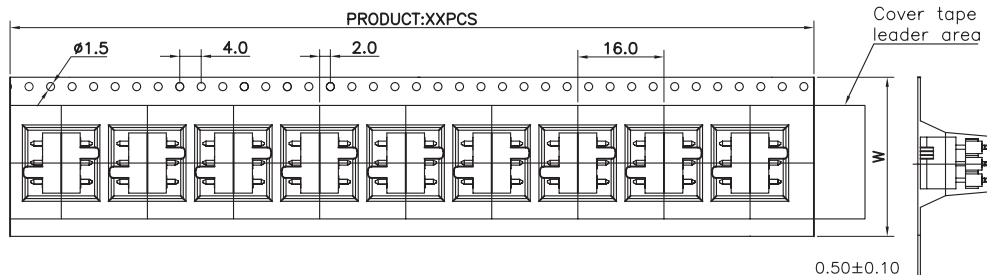

Pin No	W	A	PCS/R	R/CTN	Q'TY
04-08	24	29	300	9	2700
10-14	32	37	300	7	2100
16-24	44	49	300	5	1500
26-32	56	61	300	4	1200
34-44	72	77	300	3	900

RoHS Compliant			
G			
F			
E			
D			
C			
B			
A	21-MAR-13	UPDATE	AR
REV	DATE	FILE	BY

PROJECTION:

APPROVAL: GMo

GENERAL TOLERANCE

.X = ± 0.2

.XX = ± 0.15

UNIT: MM

SCALE:

SHEET: 2/3

DRAW: MARY



DESCRIPTION: 2.54MM DUAL SMT PIN HEADER

WERI PART NO: 610 3xx 211 21

SIZE

A4

A

B

C

D

1

2

3

4

5

Cautions and Warnings:

This electronic component is designed and developed with the intention for use in general electronics equipments.



Before incorporating the components into any equipments in the field such as aerospace, aviation, nuclear control, submarine, transportation, (automotive control, train control, ship control), transportation signal, disaster prevention, medical, public information network etc. where higher safety and reliability are especially required or if there is possibility of direct damage or injury to human body, Würth Elektronik must be asked for a written approval.

In addition, even electronic component in general electronic equipments, when used in electrical circuits that require high safety, reliability functions or performance, the sufficient reliability evaluation-check for the safety must be performed before by the user before usage.

A

B

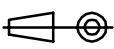
C

RoHS Compliant				PROJECTION: 	GENERAL TOLERANCE .X = +/- 0.2 .XX = +/- 0.15	 WÜRTH ELEKTRONIK	DESCRIPTION: DISCLAIMER	SIZE A4
G								
F								
E								
D								
C				APPROVAL: JC	UNIT: MM	WERI PART NO: DISCLAIMER	SIZE A4	
B				SCALE:				
A	10-SEP-14	PDF	QL	SHEET: 3/3				
REV	DATE	FILE	BY	DRAW: QL				

D

Looking for pricing, stock, or lifecycle information?

Click below to explore more details on WIN SOURCE:

 [View 61031221121 on WIN SOURCE](#)

 [Wurth Electronics Inc Information](#)

Optimize Your Supply Chain with WIN SOURCE Solutions

-  Global Sourcing Solution
-  Obsolete Management
-  Cost Control Management
-  Shortage Management
-  Alternative Solution
-  Excess Inventory Management