

Compact Automotive Connector with 0.64mm Size Terminal CONNECTOR

MX34 Series

MB-0360-3

Nov.2021

RoHS Compliant

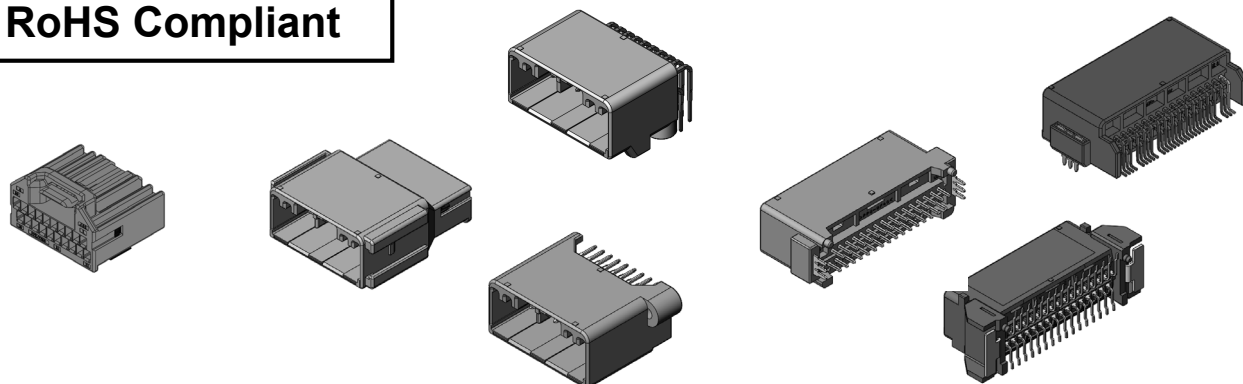

The MX34 series is a non-waterproof connector with a 0.64 mm size terminal that meets various requirements for automotive applications, and has been adopted for many automotive ECU applications. Since its development, a lineup for MX34 Series has been enhanced with a wide variety of variations.

Applicable Market

General purpose automotive electrical control units (ECU), battery system components for electric vehicles (EV), and Battery Management System applications (BMS)

Features

- Non-waterproof connector with 0.64mm size terminals
- Durable socket terminal that uses a 2-layer spring structure for contact area
- Retainer that detects incomplete insertion of terminals during harness work
- Bridge structure on the lock spring supports external load
- Variations for pin side is available for inline connection, and SMT or DIP mounting type for vertical and horizontal connection to board
- USCAR2 tested

General Specifications

Number of Contacts	3~40 position (please refer to next page for details)	Rated Current	3A
Contact Resistance	5mΩ max. (initial)	Insulation Resistance	100MΩ min.
	10mΩ max. (posttest)	Mating Cycles	50 times
Dielectric Withstanding Voltage	AC 1000V r.m.s for 1 minute	Operating Temperature	-40°C ~+85°C

Ordering Information

MX34 0 03 S F *(~)

Series

Modification Code* :
Please refer to Page 5 onwards
for further details

Plating Specification F: Sn plating

Connector Type
0: Standard
E: 8 position in different array
Q: Reflow DIP Type
R: SMT Type

Connection Type
Cable connection
S: Socket side, **P**: Pin side
Board connection (for pin side only)
Angle **N**: DIP, **H**: SMT
Straight **U**: Flow DIP, **T**: Reflow DIP, **V**: SMT

Number of Contacts:
03 ~ 40 positions

Product List and Mating Combinations

Number of Contacts	Socket Side		Pin Side					
	Cable connection	↔	Cable connection	Board connection				
				Angle Flow DIP	Angle SMT	Straight Flow DIP	Straight Reflow DIP	Straight SMT
3	MX34003SF1	↔		MX34003NF1 MX34003NF3	MX34R03HF4T			
5	MX34005SF1	↔		MX34005NF1 MX34005NF3	MX34R05HF4T MX34R05HF4R150	MX34005UF1		
7	MX34007SF1	↔	(Note 1)	MX34007NF1	MX34R07HF4T MX34R07HF4R150	MX34007UF1		
	MX34007SF4	↔					MX34007UF4	
8	MX34008SF4	↔			MX34R08HF4T			
	MX34E08SF1	↔		MX34E08NF1 MX34E08NF3				
12	MX34012SF1	↔	MX34012PF1	MX34012NF1 MX34012NF3	MX34R12HF4T	MX34012UF1 MX34012UF3		MX34R12VF1
	MX34012SF4	↔	-	MX34012NF4	MX34R12HF8T	MX34012UF4		
16	MX34016SF1	↔	MX34016PF1	MX34016NF1 MX34016NF3	MX34R16HF4T MX34R16HF4R110	MX34016UF1 MX34016UF3		
	MX34020SF1	↔	MX34020PF1	MX34020NF1 MX34020NF3	MX34R20HF4T	MX34020UF1 MX34020UF3	MX34Q20ATF8T40	MX34R20VF1
24	MX34024SF1	↔	(Note 1)	MX34024NF1 MX34024NF3	MX34R24HF4T	MX34024UF1 MX34024UF3		
	MX34024SF4	↔		MX34024NF4				
28	MX34028SF1	↔	(Note 1)	MX34028NF2 MX34028NF3	MX34R28HF4T	MX34028UF2 MX34028UF3		
	32	MX34032SF1	↔	MX34032NF2 MX34032NF3	MX34R32HF4T	MX34032UF2 MX34032UF3	MX34Q32BTF1 MX34Q32BTF1T30 MX34Q32BTF1R200	MX34R32VF1
						MX34Q32BTF2-1T30		
MX34032SF4		↔		MX34032NF4	MX34R32HF8T			
36	MX34036SF1	↔		MX34036NF2 MX34036NF3	MX34R36HF4T MX34R36HF4R110	MX34036UF2 MX34036UF3		
				MX34040SF1	↔		MX34040NF2 MX34040NF3	

Note 1) Please use MX84 series cables, for 7, 24, and 28 cable connection including the socket side. (For MX84 series, please refer to reference number MB-0330-*.)

Materials and Finishes

Socket Housing (Cable connection)

Component	Material
Housing	PPE + PA66 (ALLOY)
Retainer	PPE + PA66 (ALLOY)

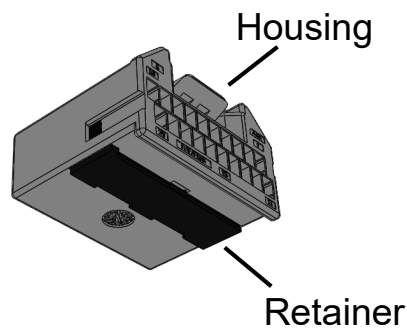

Socket Contact (Cable connection)

Component	Material / Finish
Contact	Highly Conductive Copper Alloy / Sn plating

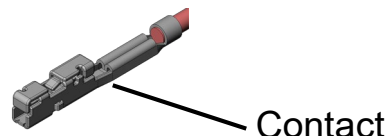

Pin Housing (Cable connection)

Component	Material / Finish
Housing	PPE + PA66(ALLOY)
Retainer	PPE + PA66(ALLOY)

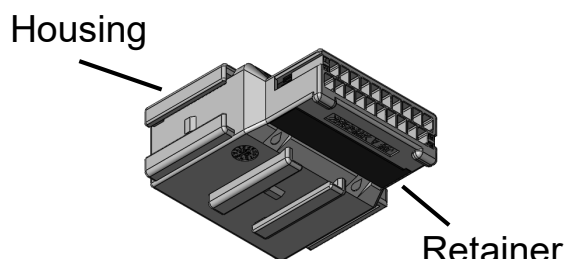

Pin Contact (Cable connection)

Component	Material / Finish
Contact	Highly Conductive Copper Alloy / Sn plating

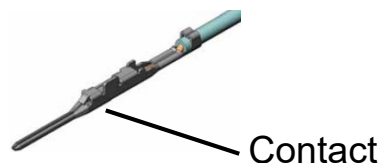

Angle Pin Header (Flow DIP)

Component	Material / Finish
Housing	SPS GF 30
Contact	Brass/ Sn plating
Hook Pin <small>*With screw hole, not available for pin count larger than 12 position</small>	Copper Alloy / Sn plating

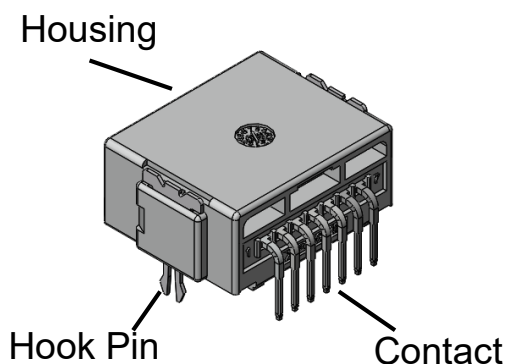

Angle Pin Header (SMT)

Component	Material / Finish
Housing	PPS GF 40
Contact	Copper Alloy / Sn plating
Leg	Brass/ Sn plating

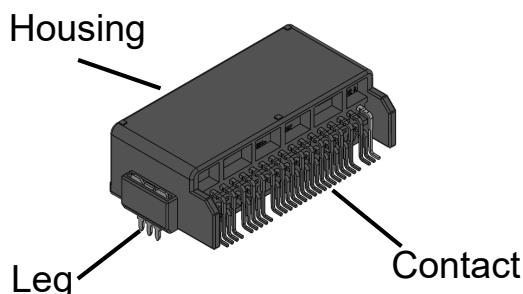

Materials and Finishes

Straight Pin Header (Flow DIP)

Components	Material / Finish
Housing	SPS GF 30
Contact	Brass / Sn plating
Hook Pin *With screw hole, not available for pin count larger than 12 position	Copper alloy / Sn plating

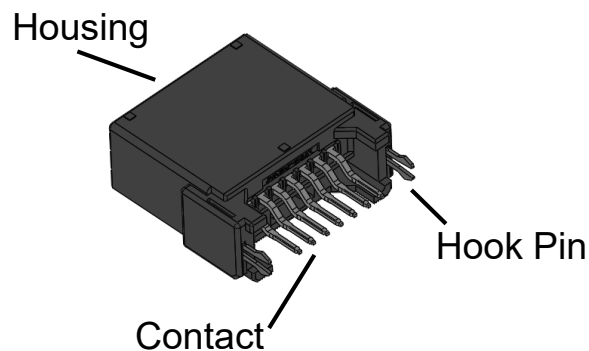
**Straight Pin Header (Reflow DIP)**

Components	Material / Finish
Housing	PPS GF 40
Contact	Copper alloy / Sn plating
Leg *Not available for 20 position	Brass / Sn plating

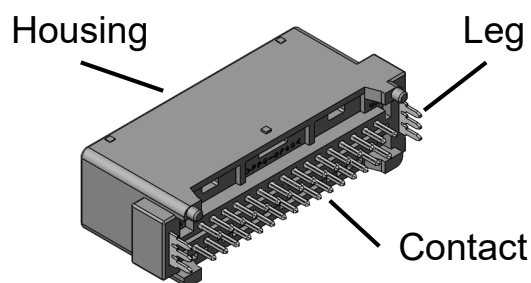
**Straight Pin Header (SMT)**

Components	Material / Finish
Housing	PPS GF 40
Contact	Copper alloy / Sn plating
Hold-down	Brass / Sn plating

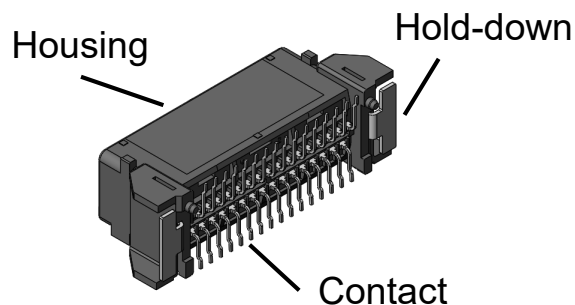

Drawing Number

■ Socket Housing / Pin Housing (Cable connection type)

Num ber of Cont acts	Socket Housing			Pin Housing	
	Part Number	Drawing		Part Number	Drawing
3	MX34003SF1	SJ100823	⇔		
5	MX34005SF1	SJ100825	⇔		
7	MX34007SF1	SJ104416	⇔	(Note 1)	
	MX34007SF4 (Note 3)	SJ109859	⇔		
8	MX34008SF4	SJ109127	⇔		
	MX34E08SF1 (Note 2)	SJ106203	⇔		
12	MX34012SF1	SJ100717	⇔	MX34012PF1	SJ111563
	MX34012SF4 (Note 3)	SJ108275	⇔		
16	MX34016SF1	SJ038754	⇔	MX34016PF1	SJ112590
20	MX34020SF1	SJ038752	⇔	MX34020PF1	SJ104399
24	MX34024SF1	SJ100271	⇔	(Note 1)	
	MX34024SF4 (Note 3)	SJ107990	⇔		
28	MX34028SF1	SJ038623	⇔	(Note 1)	
32	MX34032SF1	SJ038756	⇔		
	MX34032SF4 (Note 3)	SJ114408	⇔		
	MX34032SF5 (Note 3)	SJ114627	⇔		
36	MX34036SF1	SJ100270	⇔		
40	MX34040SF1	SJ038526	⇔		

Note 1) Please use MX84 series cables, for 7, 24, and 28 cable connection including the socket side. (For MX84 series, please refer to reference number MB-0330-*.)

Note 2) Basically, for the mating combination of socket side and pin side the insulators should be of the same or similar color.

However, for MX34E08~ socket side is light blue and the pin side is black. In addition, the contact arrangement of the mating part of the MX34E08~ is different from that of the MX34008~. (See the figure below)

<MX34008SF4>
(Standard type)

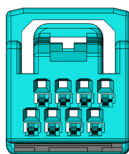

<MX34E08SF1>

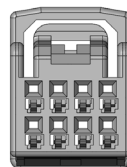

Note 3) This product is different key mating type.

Drawing Number

■ Socket Contact (For cable connection type)

Part Number	Drawing	Applicable Cable
M34S75C4F1	SJ038527	AVSS 0.3mm ² , CHFUS 0.22~0.35mm ²
M34S75C4F2	SJ038528	AVSS 0.5mm ² , CHFUS 0.5~0.75mm ² CAVS 0.5mm ² , CHFS 0.75mm ²
M34S75C4F3 (Note 4)	SJ038747	CAN SD 0.35mm ²
M34S75C4F4 (Note 4)	SJ038893	AVSS 0.85mm ² , CAVS 0.85mm ²
M34S75C4F5	SJ109336	CHFUS 0.13mm ²

Note 4) M34S75C4F3 / 4 can only be inserted into the two housing cavity positions at the both ends of the connector.

(8 position type MX34E08SF1 can be inserted in all locations.)

• Handling Instruction for Crimp tool for Socket Contact is as below.

Applicable Contact	Hand Crimp Tool	Semi-automatic Applicator	Automatic Applicator
M34S75C4F1	CT150-2-MX34 (T700261)	3502-MX34D-2 (T703418)	3502-MX34D-3B (T703501)
M34S75C4F2	CT150-2B-MX34 (T700261)		
M34S75C4F5	—		
M34S75C4F3,4	CT150-2C-MX34 (T700392)	3502-MX34C-2 (Please contact us for details)	3502-MX34C-3B (Please contact us for details)

• Extraction tool for Socket Contact is "ET-MX34-1" (T711140).

■ Pin Contact (Cable connection type)

Part Number	Drawing	Applicable Cable (Note)
M34P75C4F1	SJ103146	AVSS 0.3mm ² , CHFUS 0.22~0.35mm ²
M34P75C4F2	SJ103147	AVSS 0.5mm ² , CHFUS 0.5~0.75mm ² CAVS 0.5mm ²
M34P75C4F5	SJ109337	CHFUS 0.13mm ²

• Handling Instruction for Crimp tool for Pin Contact is a below.

Applicable Contact	Hand Crimp Tool	Semi-automatic Applicator	Automatic Applicator
M34P75C4F1	CT150-2-MX34 (T700261)	3502-MX34D-2 (T703418)	3502-MX34D-3B (T703501)
M34P75C4F2	CT150-2B-MX34 (T700261)		
M34P75C4F5	—		

• Extraction tool for Pin contact is "ET-MX34P-1" (T711154).

Drawing Number

■ Angle Pin Header

Num ber of Con tacts	Socket Housing			Angle Pin Header (Flow DIP)		Angle Pin Header (SMT)	
	Part Number	Drawing		Part Number	Drawing	Part Number	Drawing
3	MX34003SF1	Please refer to Page 5	⇔	MX34003NF1	SJ100824	MX34R03HF4T	SJ110327
				MX34003NF3 (Note 5)	SJ110997		
5	MX34005SF1	Please refer to Page 5	⇔	MX34005NF1	SJ100826	MX34R05HF4T	SJ110328
				MX34005NF3 (Note 5)	SJ116927	MX34R05HF4R150 (Note 6)	SJ118052
7	MX34007SF1	Please refer to Page 5	⇔	MX34007NF1	SJ104514	MX34R07HF4T	SJ110662
						MX34R07HF4R150 (Note 6)	SJ118053
8	MX34008SF4	Please refer to Page 5	⇔			MX34R08HF4T	SJ110338
	MX34E08SF1	Please refer to Page 5	⇔	MX34E08NF1	SJ106197		
				MX34E08NF3 (Note 5)	SJ116929		
12	MX34012SF1	Please refer to Page 5	⇔	MX34012NF1	SJ100715	MX34R12HF4T	SJ110663
				MX34012NF3 (Note 5)	SJ107602		
	MX34012SF4	Please refer to Page 5	⇔	MX34012NF4 (Note 3)	SJ118320	MX34R12HF8T (Note 3)	SJ114629
16	MX34016SF1	Please refer to Page 5	⇔	MX34016NF1	SJ038753	MX34R16HF4T	SJ110664
				MX34016NF3 (Note 5)	SJ107603	MX34R16HF4R110 (Note 6)	SJ118054
20	MX34020SF1	Please refer to Page 5	⇔	MX34020NF1	SJ038751	MX34R20HF4T	SJ110665
				MX34020NF3 (Note 5)	SJ107604		
24	MX34024SF1	Please refer to Page 5	⇔	MX34024NF1	SJ100269	MX34R24HF4T	SJ110666
				MX34024NF3 (Note 5)	SJ107605		
	MX34024SF4	Please refer to Page 5	⇔	MX34024NF4 (Note 3)	SJ107989		
28	MX34028SF1	Please refer to Page 5	⇔	MX34028NF2	SJ106304	MX34R28HF4T	SJ119976
				MX34028NF3 (Note 5)	SJ107606		
32	MX34032SF1	Please refer to Page 5	⇔	MX34032NF2	SJ106305	MX34R32HF4T	SJ110668
				MX34032NF3 (Note 5)	SJ107607		
	MX34032SF4	Please refer to Page 5	⇔	MX34032NF4 (Note 3)	SJ114407	MX34R32HF8T (Note 3)	SJ114413
	MX34032SF5	Please refer to Page 5	⇔	MX34032NF5 (Note 3)	SJ114626	MX34R32HFDT (Note 3)	SJ114628
36	MX34036SF1	Please refer to Page 5	⇔	MX34036NF2	SJ106307	MX34R36HF4T	SJ110669
				MX34036NF3 (Note 5)	SJ107608	MX34R36HF4R110 (Note 6)	SJ118055
40	MX34040SF1	Please refer to Page 5	⇔	MX34040NF2	SJ106309		
				MX34040NF3 (Note 5)	SJ107609		

Note 3) This product is different key mating type.

Note 5) Contacts for part number (~F3) is post plated, (~F1 or ~F2) is pre plated.
The only difference between the two last digits of the part number is plating.

Note 6) Only the packaging (~T : stick, ~R : embossed) of these 2 items are different.

Drawing Number

■ Straight Pin Header

Number of Contacts	Socket Housing			Straight Pin Header (Flow DIP)		Straight Pin Header (Reflow DIP)	
	Part Number	Drawing		Part Number	Drawing	Part Number	Drawing
5	MX34005SF1	Please refer to Page 5	⇔	MX34005UF1	SJ104369		
7	MX34007SF1	Please refer to Page 5	⇔	MX34007UF1	SJ104370		
	MX34007SF4	Please refer to Page 5	⇔	MX34007UF4 (Note 3)	SJ109858		
12	MX34012SF1	Please refer to Page 5	⇔	MX34012UF1	SJ100716		
				MX34012UF3 (Note 5)	SJ107610		
	MX34012SF4	Please refer to Page 5	⇔	MX34012UF4 (Note 3)	SJ108274		
16	MX34016SF1	Please refer to Page 5	⇔	MX34016UF1	SJ038766		
				MX34016UF3 (Note 5)	SJ107611		
20	MX34020SF1	Please refer to Page 5	⇔	MX34020UF1	SJ038765	MX34Q20ATF8T40 (Note 7)	SJ121464-1
				MX34020UF3 (Note 5)	SJ107612		
24	MX34024SF1	Please refer to Page 5	⇔	MX34024UF1	SJ100221		
				MX34024UF3 (Note 5)	SJ107613		
28	MX34028SF1	Please refer to Page 5	⇔	MX34028UF2	SJ106312		
				MX34028UF3 (Note 5)	SJ107614		
32	MX34032SF1	Please refer to Page 5	⇔	MX34032UF2	SJ106313	MX34Q32BTF1 (Note 8)	SJ119062
				MX34032UF3 (Note 5)	SJ107615	MX34Q32BTF1T30 (Note 8)	SJ121243
						MX34Q32BTF1R200 (Note 8)	SJ121453
	MX34032SF4	Please refer to Page 5	⇔			MX34Q32BTF2-1T30 (Note 3)	SJ121244
36	MX34036SF1	Please refer to Page 5	⇔	MX34036UF2	SJ106314		
				MX34036UF3 (Note 5)	SJ107616		
40	MX34040SF1	Please refer to Page 5	⇔	MX34040UF2	SJ106315		
				MX34040UF3 (Note 5)	SJ107617		

Number of Contacts	Socket Housing			Straight Pin Header (SMT)	
	Part Number	Drawing		Part Number	Drawing
12	MX34012SF1	Please refer to Page 5	⇔	MX34R12VF1	SJ109156
20	MX34020SF1	Please refer to Page 5	⇔	MX34R20VF1	SJ106351
32	MX34032SF1	Please refer to Page 5	⇔	MX34R32VF1	SJ106352

Note 3) This product has different key mating type.

Note 5) Contacts for part number (~F3) is post plated, (~F1 or ~F2) is pre plated.

The only difference between the two last digits of the part number is plating.

Note 7) This product is fixed by the contact DIP area (without leg) only.

Please secure sufficient strength in the housing accordingly to the situation of usage before use .

Note 8) Only the packaging (stick, tray, embossed) of these 3 items are different.

Outer Dimensions

■ Socket Housing

Unit: mm

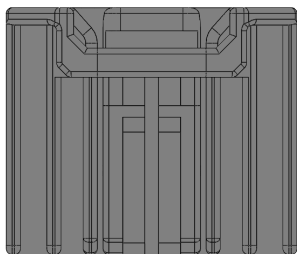

Note) Drawing of 20 position type

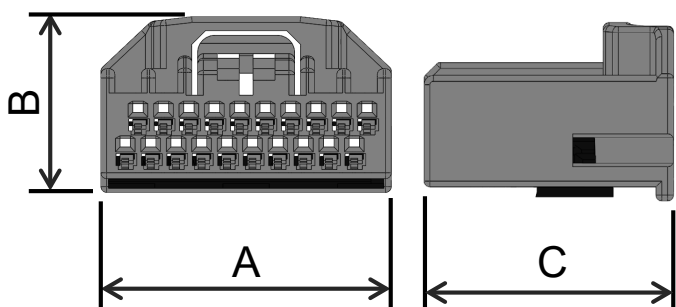

Number of Contacts		Dimension A	Dimension B	Dimension C
3		10.8	12.2	21.3
5		15.2		
7		19.6		
8	MX340	12.9	15.2	
	MX34E	11.7	15.7	
12		16.3	15.2	
16		20.7		
20		25.1		
24		29.5		
28		33.9		
32		38.3		
36		42.7		
40		47.1		

■ Pin Housing

Unit: mm

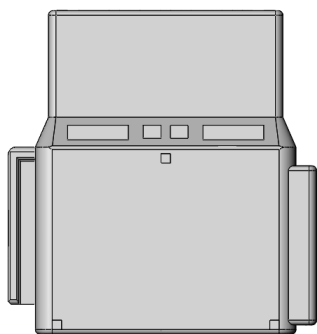

Number of Contacts	Dimension A	Dimension B	Dimension C
12	24.2	15.6	34.8
16	28.6		
20	33		

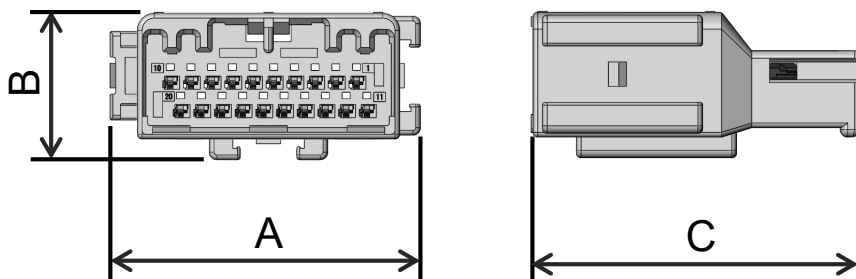

Note) Drawing of 20 position type

Outer Dimensions

■ Angle Pin Header (DIP)

Unit: mm

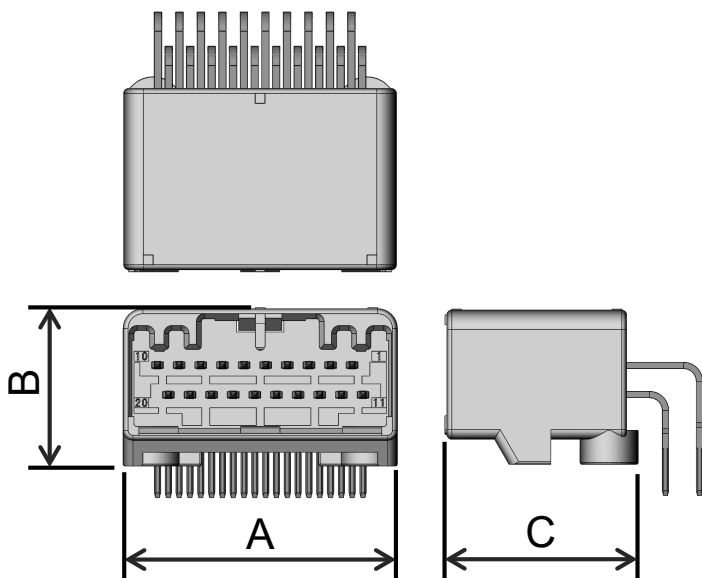

Note) Drawing of 20 position type

Number of Contacts	Dimension A	Dimension B	Dimension C
3	15.8	10.7	18.7
5	20.4		
7	24.8		
8 (MX34E)	18.1	14.2	18.1
12	19.1	16	19.9
16	23.5		
20	27.9		
24	32.3		
28	36.7		
32	41.1		
36	45.5		
40	49.9		

■ Angle Pin Header (SMT)

Unit: mm

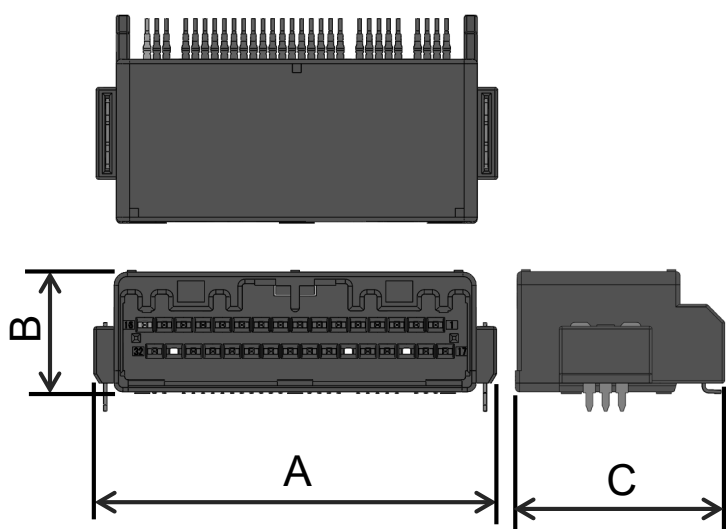

Note) Drawing of 32 position type

Number of Contacts	Dimension A	Dimension B	Dimension C
3	18	10.9	23.75
5	22.6		
7	27		
8	20.1	14	
12	23.7		
16	28.1		
20	32.5		
24	36.9		
28	41.3		
32	45.7		
36	50.1		

Outer Dimensions

■ Straight Pin Header (Flow DIP)

Unit: mm

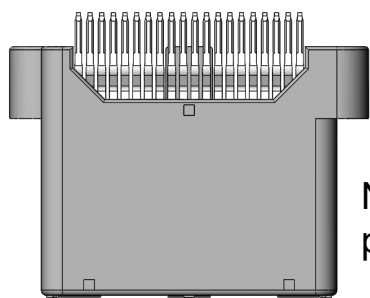

Note) Drawing of 20 position type

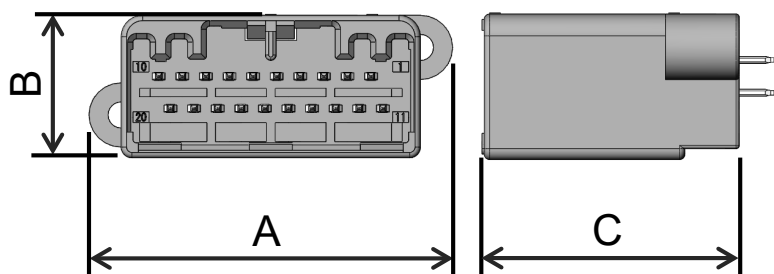

Number of Contacts	Dimension A	Dimension B	Dimension C
5	20.4	10.4	23.7
7	24.8		
12	25.1	13.4	
16	29.5		
20	33.9		
24	38.3		
28	42.7		
32	47.1		
36	51.5		
40	55.9		

■ Straight Pin Header (Reflow DIP)

Unit: mm

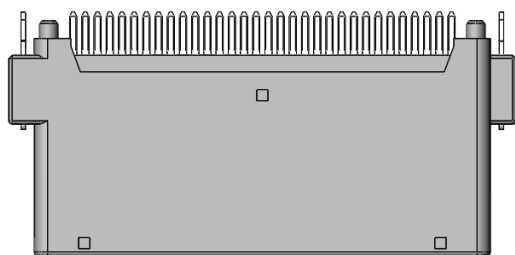

Number of Contacts	Dimension A	Dimension B	Dimension C
20	32.5	13.3	19.8
32	45.7		

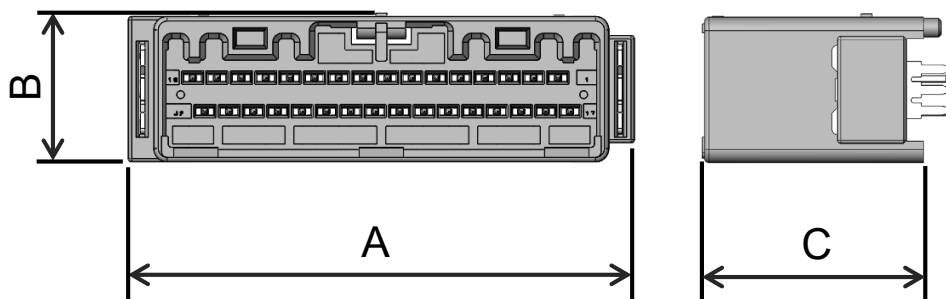

Note) Drawing of 32 position type

Outer Dimensions

■ Straight Pin Header (SMT)

Unit: mm

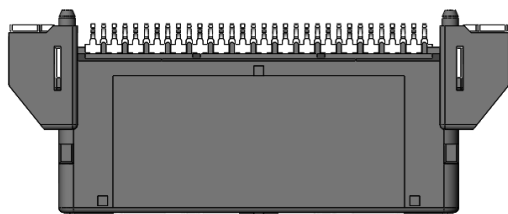

Number of Contacts	Dimension A	Dimension B	Dimension C
12	29.4	16	19.5
20	38.2		
32	51.4		

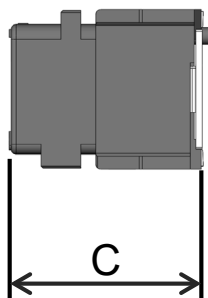
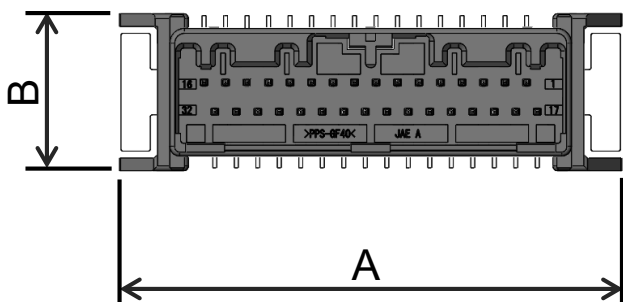

Note) Drawing of 32 position type

Technical Documents

	Specifications	Handling Instructions
Pin Housing (Cable connection)	JACS-1754-4	J AHL-1754-1
Socket SMT Type	JACS-1754-10	J AHL-1754
Others	JACS-1754	

Notice:

1. The values specified in this brochure are only for reference. The products and their specifications are subject to change without notice. Contact our sales staff for further information before considering or ordering any of our products. For purchase, a product specification must be agreed upon.

2. Users are requested to provide protection circuits and redundancy circuits to ensure safety of the equipment, and sufficiently review the suitability of JAE's products to the equipment.

3. The products presented in this brochure are designed for the uses recommended below. We strongly suggest you contact our sales staff when considering use of any of the products in any other way than the recommended applications or for a specific use that requires an extremely high reliability.

(1) Applications that require consultation:

(i) Please contact us if you are considering use involving a quality assurance program that you specify or that is peculiar to the industry, such as:

Automotive electrical components, train control, telecommunications devices (mainline), traffic light control, electric power, combustion control, fire prevention or security systems, disaster prevention equipment, etc.

(ii) We may separately give you our support with a quality assurance program that you specify, when you think of a use such as :

Aviation or space equipment, submarine repeaters, nuclear power control systems, medical equipment for life support, etc.

(2) Recommended applications include:



Computers, office appliances, telecommunications devices (terminals, mobile units), measuring equipment, audiovisual equipment, home electric appliances, factory automation equipment, etc.

Japan Aviation Electronics Industry, Limited







* The specifications in this brochure are subject to change without notice. Please contact JAE for information.

Looking for pricing, stock, or lifecycle information?

Click below to explore more details on WIN SOURCE:

-  [View MX34012UF1](#) on WIN SOURCE
-  [JAE Electronics](#) Information

Optimize Your Supply Chain with WIN SOURCE Solutions

-  Global Sourcing Solution
-  Obsolete Management
-  Cost Control Management
-  Shortage Management
-  Alternative Solution
-  Excess Inventory Management