

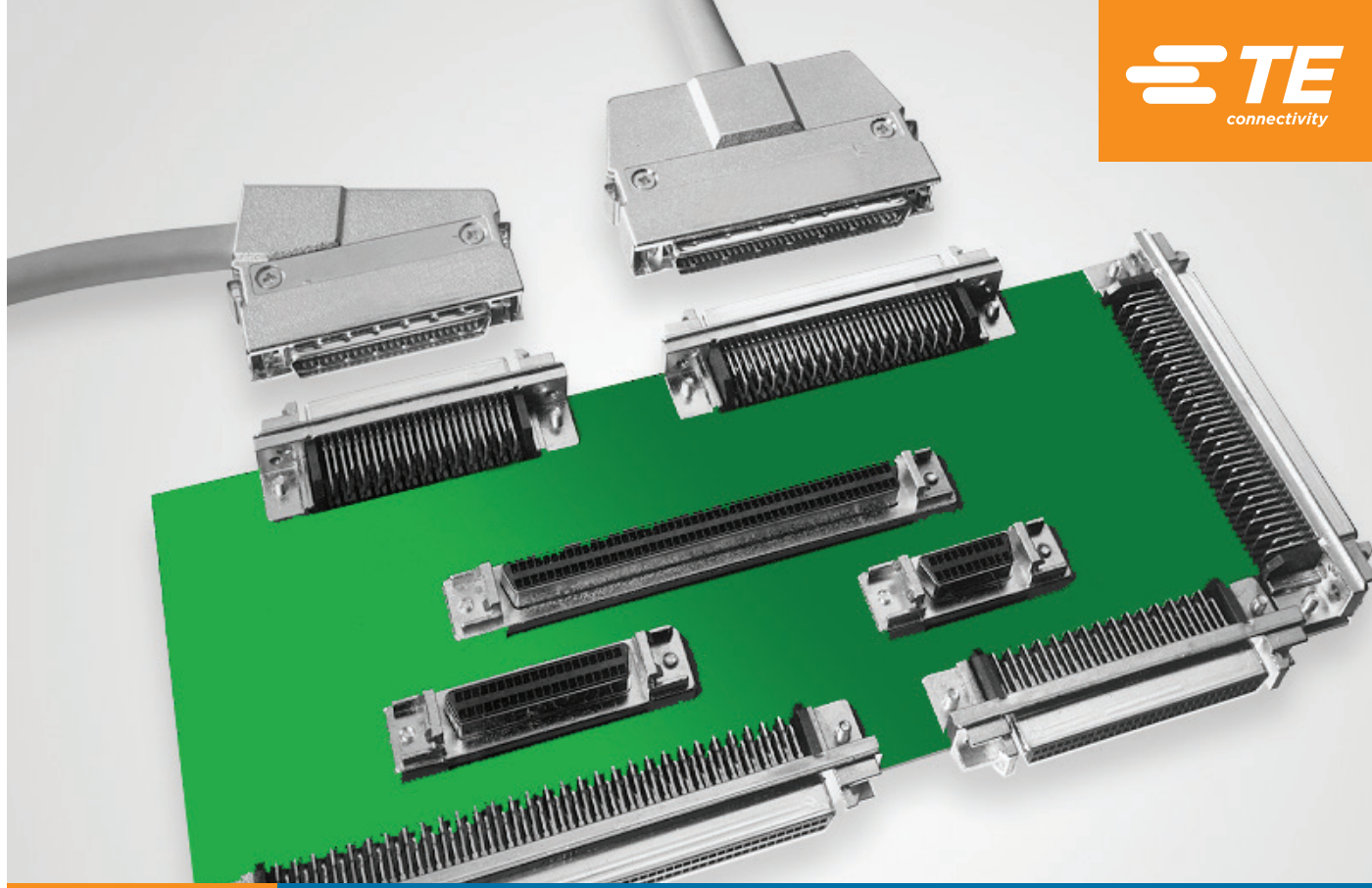

THE DATASHEET OF
5749080-1





AMPLIMITE .050 Series Connectors

(.050 x .100 [1.27 x 2.54] Centerline) Series III

Quick Reference Guide

We offer one of the broadest and most versatile portfolios of D-subminiature connectors in the market with unrivaled engineering support to address our customer's needs. Our reliable AMPLIMITE D-sub .050 series connector portfolio offers a high density D type interface and includes right angle and vertical D-sub. Both versions have three mating faces available; flat face, latch block and latch block with rails. Plug and receptacle positions include 20, 26, 28, 40, 50, 68, 80, 100 and 120 (ACTION PIN only).

AMPLIMITE .050 Series connectors utilize gold plated tab and tuning fork contacts on a compact .050 x .100 grid spacing and are available with 20 to 100 positions. The AMPLIMITE .050 series cable connectors terminate to wire via the insulation displacement contact (IDC) termination method, which provides fast, reliable and economical termination of discrete wire or ribbon cable. Both solder, and compliant pin terminations are offered on the printer circuit board versions. All connectors are produced with metal shell construction, which provides EMI/RFI shielding capability and high durability.

Features & Benefits

- High density D type interface
- 20 through 100 contact positions
- Excellent EMI/RFI protection
- Protect your system with shields that mate before contacts, with ground mating first and breaking last
- Squeeze-to-release latches or jackscrew hardware available to fit your needs
- Board connectors compatible with standard thru-hole flow solder and surface-mount reflow solder processes
- Recognized under the Component Program of Underwriters Laboratories Inc., file E28476
- Listed and complies with UL 1863, Communication Circuit Accessories File No. E81956
- Certified by Canadian Standards Association, File No. 1088108

Applications

- Industrial machinery
- Medical instrumentation
- Computers and peripherals
- RAID storage arrays
- File servers/routers
- Tape storage systems
- Workstations
- On-machine industrial communications
- Personal and handheld devices

AMPLIMITE .050 Series Connectors

(.050 x .100 [1.27 x 2.54] Centerline) Series III

How to Select an AMPLIMITE Connector Part Number

The charts on the following pages highlight the AMPLIMITE part numbers with the key product attributes to help identify the correct part for your application. Each section also includes a list of materials to characterize the composition of each part.

AMPLIMITE .050 Series Right Angle Receptacles

Materials

Housing: Thermoplastic, 94V-0 rated, black. SMT compatible

Shell: Steel, plated bright nickel over copper

Bracket: Zinc, plated nickel over copper

Contacts: Phosphor bronze, duplex plated .000030 [0.00076] min. gold on mating end, tin on solder end, all underplated nickel

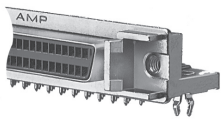

Right Angle Receptacle—Rails, Latchblocks, Boardlocks

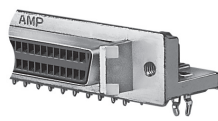

Right Angle Receptacle—Latchblocks, Boardlocks

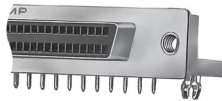

Right Angle Receptacle Boardlocks

# of Positions	Part #	With Rails	With Latchblocks	With Boardlocks	Solder Tail Length
40	1761028-2	x	x	x	.100 [2.54]
40	5787082-3	-	x	x	.100 [2.54]
40	5787170-4	-	-	x	.100 [2.54]
50	5787190-5	x	x	-	.100 [2.54]
50	1761028-3	x	x	x	.100 [2.54]
50	5787394-5	-	x	-	.100 [2.54]
50	5787082-5	-	x	x	.100 [2.54]
50	5787170-5	-	-	x	.100 [2.54]
50	5787362-5	-	-	x	.120 [3.05]
50	5787266-5	x	x	x	.100 [2.54]
50	5787395-5	-	x	x	.100 [2.54]
68	5787190-7	x	x	-	.100 [2.54]
68	1761028-4	x	x	x	.100 [2.54]
68	5787394-7	-	x	-	.100 [2.54]
68	5787082-7	-	x	x	.100 [2.54]
68	5787169-7	-	-	-	.100 [2.54]
68	5787170-7	-	-	x	.100 [2.54]
68	5787362-7	-	-	x	.120 [3.05]
100	1761028-5	x	x	x	.100 [2.54]
100	5787082-9	-	x	x	.100 [2.54]
100	5787169-9	-	-	-	.100 [2.54]
100	5787170-9	-	-	x	.100 [2.54]
100	5787362-9	-	-	x	.120 [3.05]

AMPLIMITE .050 Series Vertical Receptacles

Vertical Receptacle Headers With Through Hole Tails

# of Positions	Part #	With Rails	With Latchblocks	With Boardlocks
20	5749069-1	x	x	-
26	5749069-2	x	x	-
28	5749721-3	-	x	-
40	5749069-4	x	x	-
50	5749069-5	x	x	-
50	5749721-5	-	x	-
50	5749070-5	-	-	-
68	5749069-7	x	x	-
68	5749721-7	-	x	-
68	5749070-7	-	-	-
80	5749069-8	x	x	-
100	5749069-9	x	x	-
100	5749070-9	-	-	-

Materials

Housing: Thermoplastic, 94V-0 rated, black. SMT compatible

Shell: Steel, plated bright nickel over copper

Bracket: Zinc, plated nickel over copper

Contacts: Phosphor bronze, duplex plated .000030 [0.00076] min. gold on mating end, tin on solder end, all underplated nickel



Vertical Receptacle With Rails/Latchblocks: 749069-5



Vertical Receptacle With Latchblocks: 749721-5

Vertical Receptacle Headers, with Action Pin Tails

# of Positions	Part #	With Rails	With Latchlocks	With Boardlocks
20	5786554-1	x	x	-
26	5786554-2	x	x	-
50	5786554-5	x	x	-
50	5786155-5	-	x	-
50	5786555-5	-	-	-
50	5786556-5	x	x	-
68	5786554-7	x	x	-
68	5786155-7	-	x	-
68	5786555-7	-	-	-
68	786155-7	-	x	-
68	5786557-7	-	-	-
100	5786554-9	x	x	-
100	5786555-9	-	-	-
120	1-5786554-0	x	x	-

Materials

Housing: Thermoplastic, 94V-0 rated, black. SMT compatible

Shell: Carbon steel, plated bright tin over copper

Bracket: Zinc, plated nickel over copper

Contacts: Phosphor bronze, duplex plated .000030 [0.00076] min. gold on mating end, tin on solder end, all underplated nickel



Vertical Receptacle Without Rails or Latchlocks: 49070-7

AMPLIMITE .050 Series Connectors

(.050 x .100 [1.27 x 2.54] Centerline) Series III

Panel Mount Plug & Receptacles

Materials

Housing and termination covers: Thermoplastic, 94V-0 rated, black

Shell (for receptacle): Steel, plated bright nickel over copper

Bracket: Zinc, plated nickel over copper

Contacts: Phosphor bronze, duplex plated .000030 [0.00076] min. gold on mating end, bright tin in termination area, all nickel underplated

Recommended wire size: 28 AWG [0.08-0.09mm²] or 30 AWG [0.05mm²], solid or 7 strand, with a .029-.036 [0.74-0.89] insulation diameter or .050 [1.27] centerline, 28 AWG [0.08-0.09mm²] stranded, PVC, flat ribbon cable

Panel Mount Receptacle Assemblies without Rails

# of Positions	Part #	Assembled Standard Termination Covers	Unassembled Wire Lacing Termination Covers
50	1-749656-1	x	-
50	5-786862-5	-	x
50	6-786862-5	-	x
50	5-750640-1	x	-
68	1-749656-2	x	-
120	6-749656-0	x	-

Panel Mount Receptacle Assemblies for .025 Centerline Ribbon Cable

# of Positions	Gold Plating	Mating Hardware	Part #
50	30m	With latch blocks and 2-56 threaded holes	5390379-5

Strain Relief for Centerline Unshielded Plug

# of Positions	Part #
68	787043-7

Panel Mount Flat Top Receptacle Assemblies

# of Positions	Part #	With Rails	With Latch-blocks	Assembled Standard Termination Covers	Unassembled Wire Lacing Termination Covers
50	5-749877-5	-	-	x	-
68	5-749877-7	-	-	x	-
100	5-749877-9	-	-	x	-

Panel Mount Receptacle Assemblies

# of Positions	Part #	With Rails	With Latch-blocks	Assembled Standard Termination Covers	Unassembled Wire Lacing Termination Covers
50	5-749611-5	x	x	x	-
50	5-750450-1	x	x	x	-
100	5-749611-9	x	x	x	-

Panel Mount Receptacle Assemblies with Rails, Latch Blocks

# of Positions	Dimension C	Dimension D	Dimension E	Dimension F	Part #
68	2.280 (57.91)	2.079 (52.81)	2.515 (63.88)	2.115 (53.72)	5-749878-7

Plug Assemblies Unshielded for .025 Centerline Ribbon Cable

# of Positions	Part #
50	5390377-5
68	5786090-7

Backshell Kit for Centerline Unshielded Plug

# of Positions	Part #
68	787032-7



Panel Mount Receptacle Without Rails and Latchblocks



Panel Mount Receptacle With Rails and Latchblocks

Cable Plug Connectors - Connector with Unassembled Wire Lacing Termination Covers

Materials

Housings and covers: Thermoplastic, 94V-0 rated, black or gray

Contacts: Phosphor bronze, duplex plated .000030 [0.00076] min. gold on mating end, tin on termination end, all underplated nickel

Shell: Steel, plated tin-nickel alloy over nickel min. copper

Recommended wire size: 28 AWG [0.08-0.09mm²] or 30 AWG [0.05mm²], solid or 7 strand, with a .029-.036 [0.74-0.89] insulation diameter

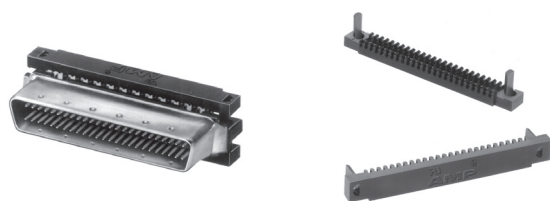

# of Positions	Part #	Outer Wire Diameter Black (.032-.036)	Outer Wire Diameter Gray (.029-.031)
26	5750913-2	x	-
26	1-5750913-2	-	x
50	5750913-5	x	-
50	1-5750913-5	-	x
68	5750913-7	x	-
68	1-5750913-7	-	x
100	1-5750913-9	-	x

Notes:

1. Plug connector requires backshell kit for complete assembly. Please see "Backshell Kit" section of Quick Reference Guide for backshell kit part numbers.
2. For termination, cover closing and wire lacing tooling, please see "Tooling" section of Quick Reference Guide.

AMPLIMITE .050 Series Connectors

(.050 x .100 [1.27 x 2.54] Centerline) Series III

Cable Plug Connectors - Connector with Standard Termination Covers

# of Positions	Part #	With Rails	With Latchblocks
20	5749111-1	x	x
20	5749621-1	-	x
26	1-5749111-0	x	x
26	5749621-2	-	x
28	5749621-3	-	x
40	5749111-3	x	x
40	5749621-4	-	x
50	5749111-4	x	x
50	5749621-5	-	x
68	5749111-6	x	x
68	5749621-7	-	x
80	5749111-7	x	x
80	5749621-8	-	x
100	5749111-8	x	x
100	5749621-9	-	x

Notes:

- Plug connector requires backshell kit for complete assembly and must use round jacketed cable (discrete or laminated). Refer to "Backshell Kit" section of Quick Reference Guide for backshell kit part numbers.
- For termination tooling, see "Tooling" section of Quick Reference Guide.

Materials

Housings and covers: Thermoplastic, 94V-0 rated, black

Contacts: Phosphor bronze, duplex plated .000030 [0.00076] min. gold on mating end, tin on termination end, all underplated nickel

Shell: Steel, plated tin-nickel alloy over nickel over copper

Recommended wire size: 28 AWG [0.08-0.09mm²] or 30 AWG [0.05mm²], solid or 7 strand, with a .029-.036 [0.74-0.89] insulation diameter

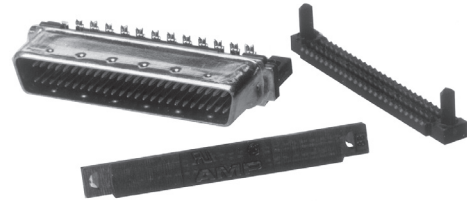

Cable Receptacle Connectors - Connectors with Standard Termination Covers

Materials

Housings and covers: Thermoplastic, 94V-0 rated, black

Contacts: Phosphor bronze, duplex plated .000030 [0.00076] min. gold on mating end, tin on termination end, all underplated nickel

Shell: Steel, plated bright tin over copper

Recommended wire size: 28 AWG [0.08-0.09mm²] or 30 AWG [0.05mm²], solid or 7 strand, with a .029-.036 [0.74-0.89] insulation diameter



# of Positions	Part #	Assembled Covers	Unassembled Covers
50	5749210-5	x	-
50	5749699-5	-	x
68	5749210-7	x	-
68	5749699-7	-	x
100	5749699-8	-	x

Notes:

- Receptacle connector requires backshell kit for complete assembly. Refer to the "Backshell Kit" section of the Quick Reference Guide for backshell kit part numbers.
- Termination, cover closing and wire lacing tool, see "tooling" section of the Quick Reference Guide.
- For termination tooling, other than wire lacing, see "tooling" section of the Quick Reference Guide.
- All part numbers are RoHS compliant.

Backshell Kits

Shielded Backshell Kits, with Jackscrews

# of Positions	Part #	Package	Male with #2-56 Threads	Female with #2-56 Threads
40	5787543-1	Bulk	x	-
40	5787543-3	Bulk	x	-
50	5749080-1	Individual	x	-
68	5750752-3	Bulk	x	-
68	5786152-3	Individual	x	-
100	5749854-1	Individual	x	-
100	5749081-1	Individual	x	-

Note:

- Each backshell kit includes upper and lower backshells, two male or female jackscrews, one strain relief staple and two or four #2-56 screws. All are packaged unassembled.

Shielded Enclosure Kits, with Male Jackscrews

# of Positions	Part #
68	5750752-1 (part number male 2-56 jackscrews)
68	5750752-2 (part number male 4-40 jackscrews)

Notes:

- Each enclosure kit contains two backshells, one boot, two jackscrews, one staple and two screws. All are packaged unassembled.
- Meets SCSI-3 standards.

Shielded Backshell Kits, with Spring Latches

# of Positions	Part #	Package	Straight Exit with Latches	Angled Exit with Latches
20	5749190-1	Individual	x	-
20	5749199-1	Individual	-	x
26	5749609-1	Individual	-	x
26	749608-2	Individual	x	-
40	5749201-1	Individual	-	x
40	5749192-1	Individual	x	-
50	5749202-2	Individual	-	x
50	5749202-3	Bulk	x	-
50	5749193-1	Individual	x	-
50	5749193-2	Individual	x	-
50	5749889-3	Bulk	x	-
68	5749204-1	Individual	-	x
68	5749195-2	Individual	x	-
68	5749204-2	Individual	-	x
80	5749205-1	Individual	-	x
80	5749196-2	Individual	x	-
100	5749197-1	Individual	x	-
100	5749206-1	Individual	-	x

Note: All parts are RoHS compliant

AMPLIMITE .050 Series Connectors

(.050 x .100 [1.27 x 2.54] Centerline) Series III

Hardware/Dust Covers

Hardware and Dust Covers

Dimension A	Dimension B	Part #	Kits	Bulk
.562 [14.27]	.157 [3.99]	749087-1	x	-
.380 [9.65]	.157 [3.99]	749087-2	x	-
.380 [9.65]	.157 [3.99]	749087-3	-	x
.562 [14.27]	.165 [4.19]	749087-4	x	-

Recommended for right-angle board mount connectors.

Hardware and Dust Covers

Thread Size A	Thread Size B	Part #	Kits	Bulk
4-40	.110 [2.79]	750644-1	x	-
2-56	.090 [2.29]	786585-2	x	-
2-56	.090 [2.29]	786585-3	-	x

Recommended for pc board mount of panel mount connectors with latches or latches and rails. Permits cable connectors to be spring latch-type or jackscrew type.

Female Screwlock Kit

Part #	Packaging
750831-1	Individual Packed Kit (2 screwlocks per kit)

Notes:

1. Minimum order is 510 kits.
2. All part numbers are RoHS compliant.

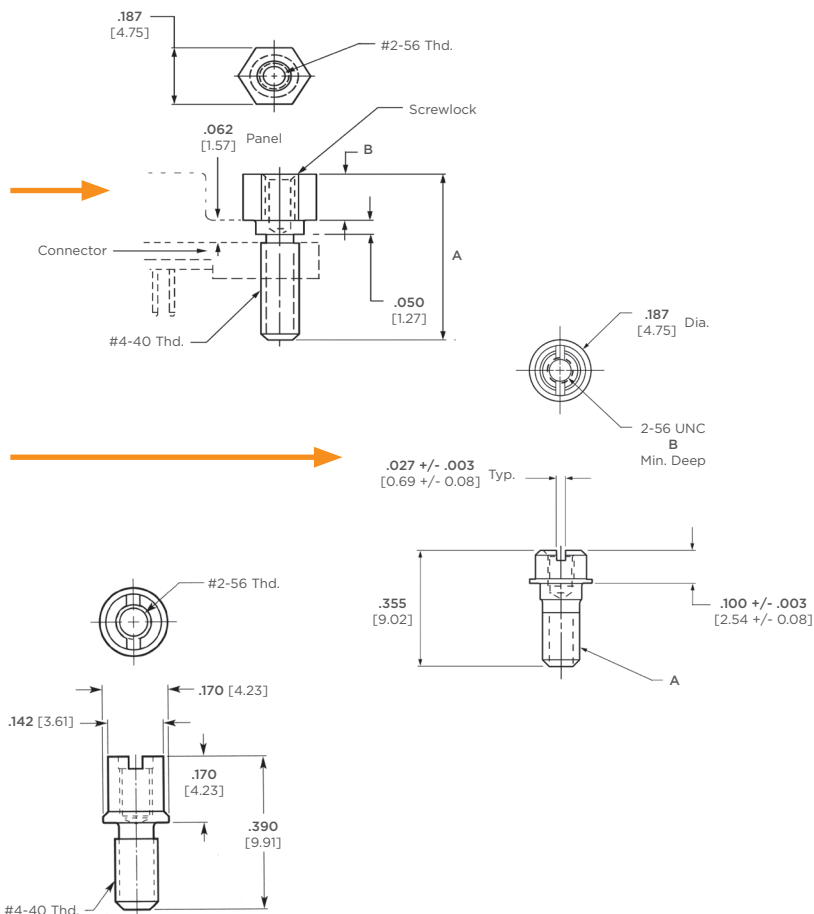

Application Tooling

Discrete Wire Application Tooling

For low to medium volume production, use the AMP arbor frame assembly—part number 58024-1, equipped with applicator—part number 91291-1 for .032-.035 [0.81-0.89] conductor insulation O.D. and applicator—part number 91291-2 for .029-.032 [0.74-0.81] conductor insulation O.D.

Cover Closing/Termination Tooling

Manual miniature applicator frame assembly—part number 91295-1. This frame requires cover closing kit—part number 543508-1.

AMPLIMITE .050 Series Connector Application Tooling for Use with Wire Lacing Terminating Covers

Manual arbor frame assembly—part number 58024-1 equipped with cover lacing assembly—part number 91293-1 (includes seating bars for 50 and 100 positions). See table 1 for seating bar part numbers.

Extra lacing stations available for use with lacing assembly—part number 91293-1 (order lower tooling assembly—part number 543481-1)

Termination Tooling for .025 Centerline Ribbon Cable

Used with manual arbor tool part number—91085-2, or pneumatic arbor tool, part number 91112-3 and universal base tool, part number 768338-4.



Arbor Frame Assembly



Miniature Applicator Frame Assembly with Cover Closing Kit



Arbor Frame Equipped with Cover Lacing Assembly

Table #1

# of Positions	Seating Bar Part #
26	543494-2
50	543494-1
68	543502-2
100	543502-1

AMPLIMITE .050 Series Connectors

(.050 x .100 [1.27 x 2.54] Centerline) Series III

Resources:

Product Specification

108-1228

Application Specification

114-40029

Instruction Sheet

408-9427

TE Technical Support Center

USA:	1.800.522.6752
Canada:	1.905.475.6222
Mexico:	52.0.55.1106.0800
Latin/S. America:	54.0.11.4733.2200
Germany:	49.0.6251.133.1999
UK:	44.0.800.267666
France:	33.0.1.3420.8686
Netherlands:	31.0.73.6246.999
China:	86.0.400.820.6015

te.com

AMP, AMPLIMITE, TE Connectivity, TE Connectivity (logo) and EVERY CONNECTION COUNTS are trademarks of the TE Connectivity Ltd. family of companies.

All other logos, products and/or company names referred to herein might be trademarks of their respective owners.

The information given herein, including drawings, illustrations and schematics which are intended for illustration purposes only, is believed to be reliable. However, TE Connectivity makes no warranties as to its accuracy or completeness and disclaims any liability in connection with its use. TE Connectivity's obligations shall only be as set forth in TE Connectivity's Standard Terms and Conditions of Sale for this product and in no case will TE Connectivity be liable for any incidental, indirect or consequential damages arising out of the sale, resale, use or misuse of the product. Users of TE Connectivity products should make their own evaluation to determine the suitability of each such product for the specific application.

© 2018 TE Connectivity Ltd. family of companies All Rights Reserved.

1-1773938-5 09/18

Looking for pricing, stock, or lifecycle information?

Click below to explore more details on WIN SOURCE:

 [View 5749080-1](#) on WIN SOURCE

 [TE Connectivity](#) Information

Optimize Your Supply Chain with WIN SOURCE Solutions

-  Global Sourcing Solution
-  Obsolete Management
-  Cost Control Management
-  Shortage Management
-  Alternative Solution
-  Excess Inventory Management