



**THE DATASHEET OF
EVM-3YSX50B25**



3 mm Square SMT Trimmer Potentiometers (Cermet, Open Frame Type)

Type: **EVM3Y**
EVM3S
EVM3R



3Y



3S



3R

■ Features

- Automatic adjustment type (EVM3Y)
- Both sides adjust type (EVM3S)
- Back side adjust type and low-profile 0.9 mm (1.0 mm max.) EVM3R
- High reliability realized by cermet element
- Excellent mountability
- Conforms to JIS C5260-1:1999

■ Recommended Applications

- Audio/visual, office, and communication equipment
- General electronic equipment

■ Explanation of Part Numbers

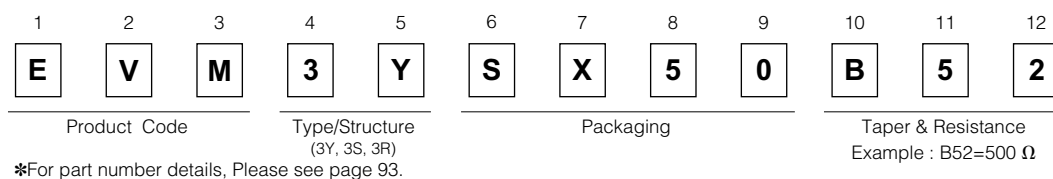

■ Specifications

Total Resistance Value Resistance Tolerance	EVM3Y 3S : 100 Ω to 1 MΩ / EVM3R : 500 Ω to 1 MΩ ±25 %
Power Rating Limiting Element Voltage	0.15 W 50 V
Rotation Torque	EVM3Y, 3S : 2 to 20 mN·m / EVM3R : 1 to 20 mN·m
Temperature Coefficient of Resistance	±250 × 10 ⁻⁶ /°C

■ Minimum Quantity/Packing Unit

Part Number	Taping		
	Quantity per reel	Packaging quantity	Dia. of reel (mm)
EVM3Y EVM3S EVM3R	2000	10000	φ178

The standard packaging methods for a reel is φ178.
Please contact us, if you would like different packaging methods. (Bulk, Reel of φ330, Reel of φ380)

Design and specifications are each subject to change without notice. Ask factory for the current technical specifications before purchase and/or use.
Should a safety concern arise regarding this product, please be sure to contact us immediately.

■ Dimensions in mm (not to scale)

- 3-terminal, for Automatic Trimming Adjustment/Low-profile EVM3Y

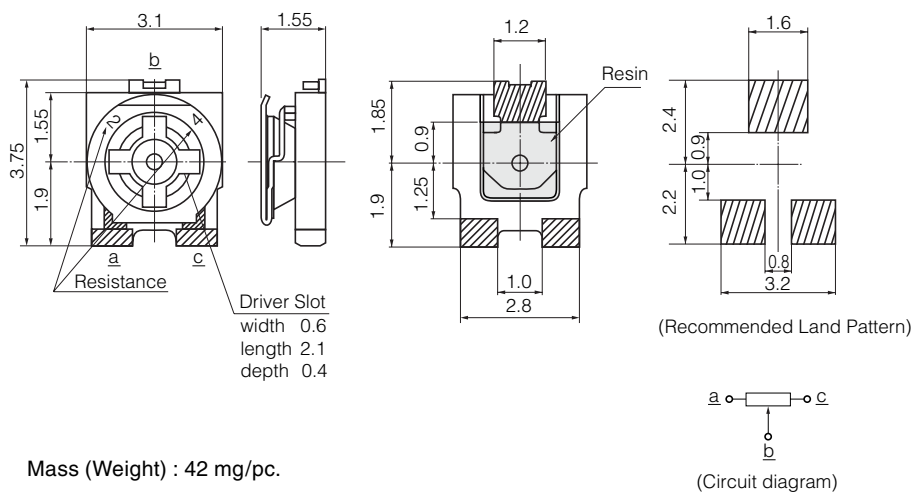
<p>No. 1</p> 	 <p style="margin-left: 40px;">Driver Slot width 0.6 length 2.1 depth 0.4</p> <p style="margin-left: 40px;">Mass (Weight) : 42 mg/pc.</p> <p style="margin-left: 40px;">(Circuit diagram)</p>
---	---

- 3-terminal, Both Sides Adjust EVM3S

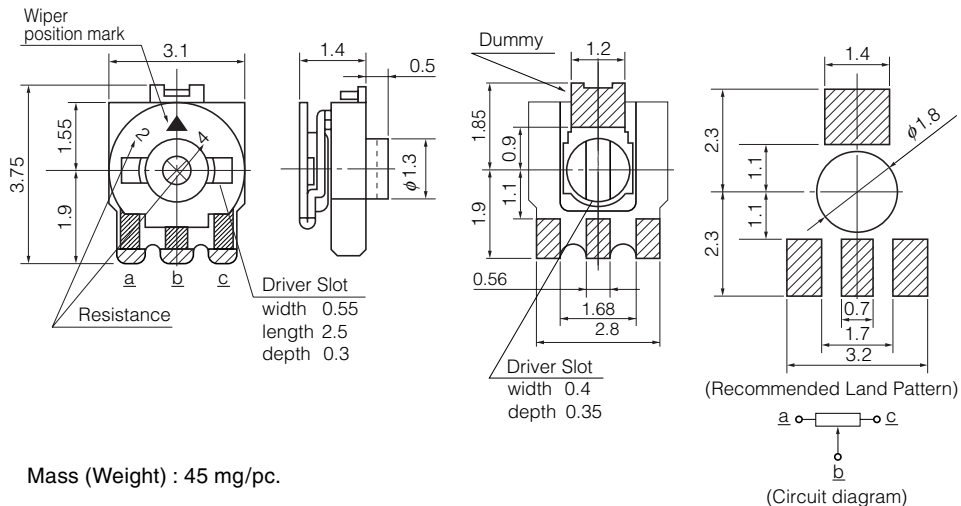
<p>No. 2</p> 	 <p style="margin-left: 40px;">Driver Slot width 0.55 length 2.5 depth 0.3</p> <p style="margin-left: 40px;">Mass (Weight) : 45 mg/pc.</p> <p style="margin-left: 40px;">(Circuit diagram)</p>
---	---

- 3-terminal, Back Side Adjust EVM3R

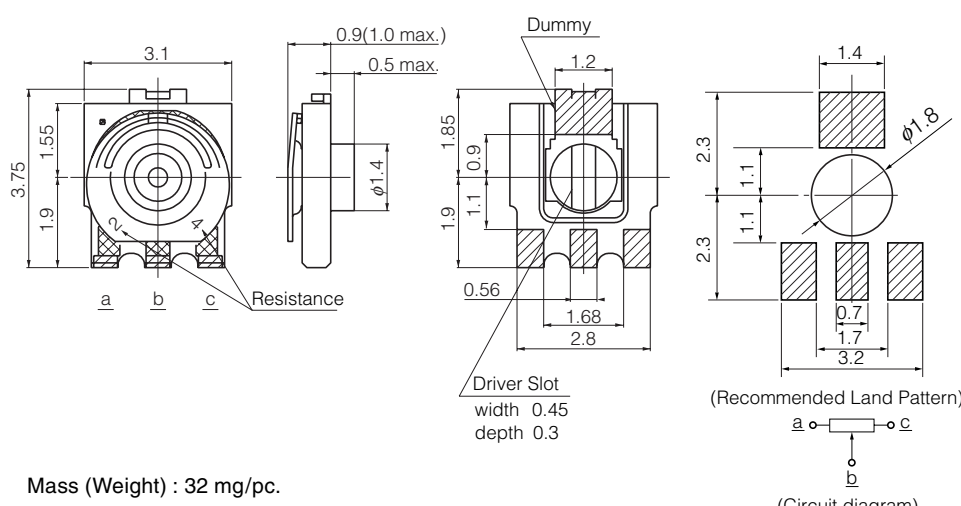
<p>No. 3</p> 	 <p style="margin-left: 40px;">Driver Slot width 0.45 depth 0.3</p> <p style="margin-left: 40px;">Mass (Weight) : 32 mg/pc.</p> <p style="margin-left: 40px;">(Circuit diagram)</p>
---	---

Design and specifications are each subject to change without notice. Ask factory for the current technical specifications before purchase and/or use. Should a safety concern arise regarding this product, please be sure to contact us immediately.

■ Explanation of Part Numbers

● SMT Trimmer Potentiometers

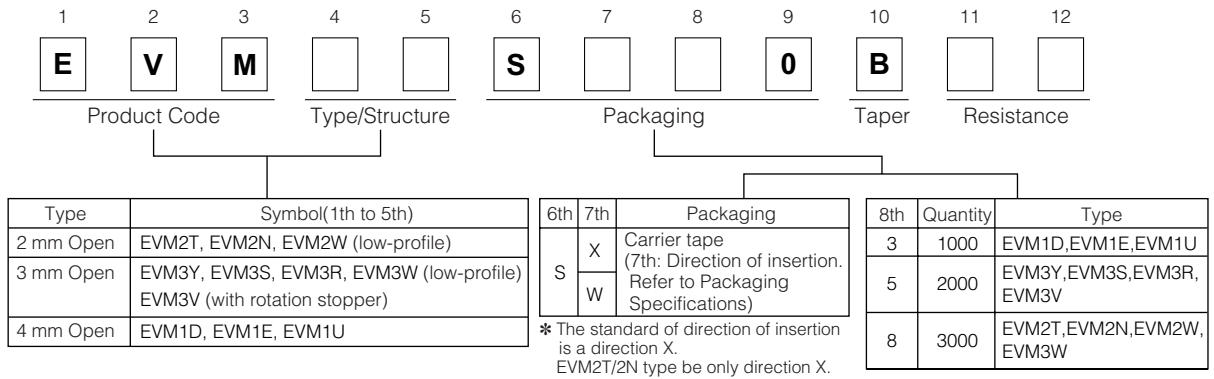

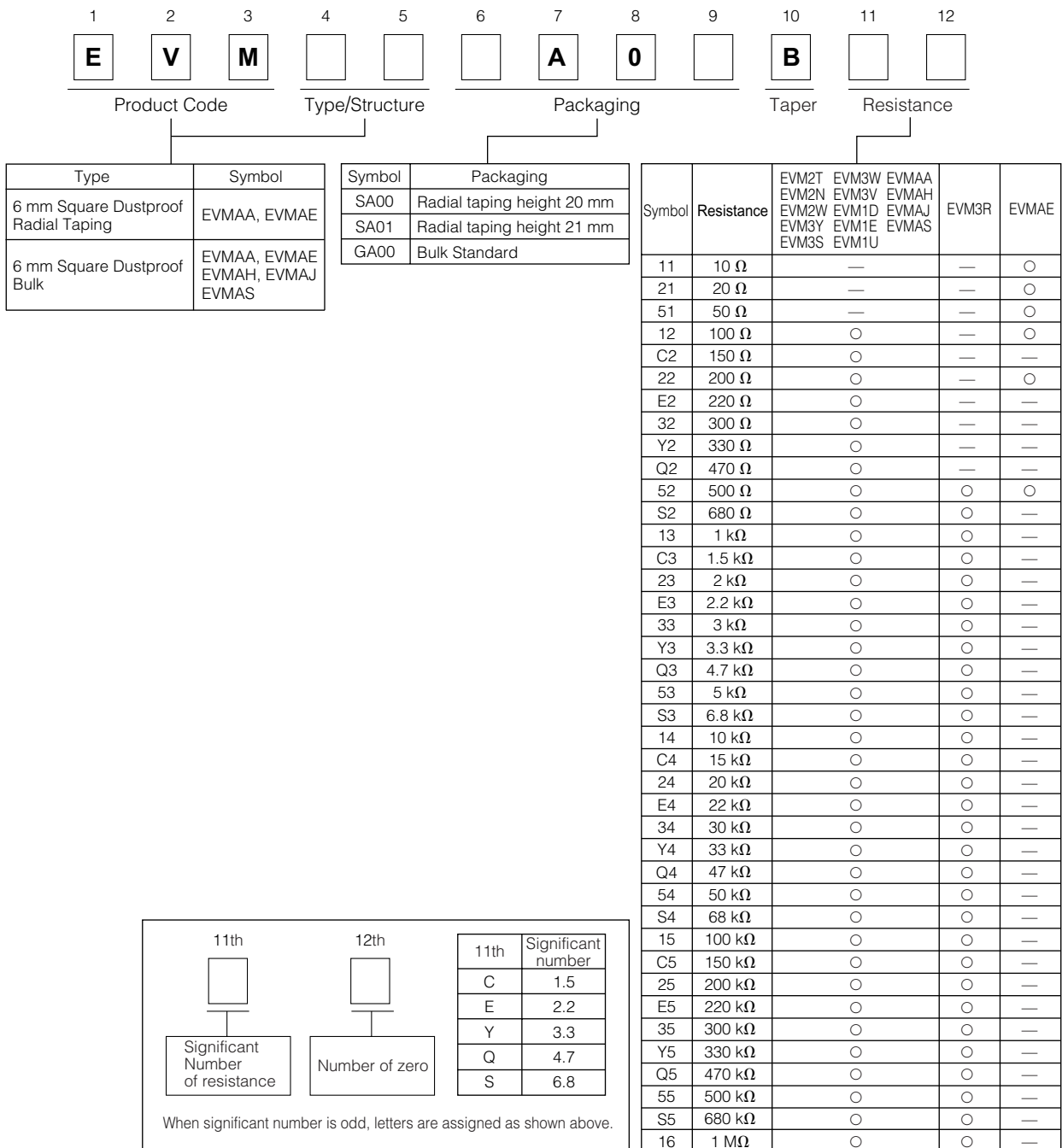

● Ceramic Trimmer Potentiometers



Looking for pricing, stock, or lifecycle information?

Click below to explore more details on WIN SOURCE:

-  [View EVM-3YSX50B25 on WIN SOURCE](#)
-  [Panasonic Information](#)

Optimize Your Supply Chain with WIN SOURCE Solutions

-  Global Sourcing Solution
-  Obsolete Management
-  Cost Control Management
-  Shortage Management
-  Alternative Solution
-  Excess Inventory Management