



**THE DATASHEET OF
RC0402FR-0754K9L**



3

2

1

LOC DW
DST

P	L/R	DESCRIPTION	DATE	DMN	APVD
C		REVISED (ECR-19-015121)	20MAR20	R.M	S.H

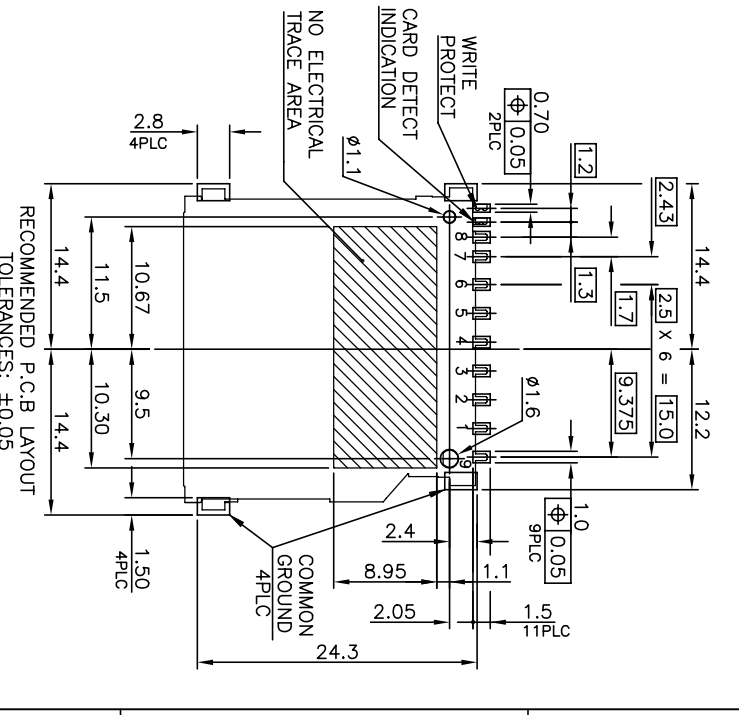
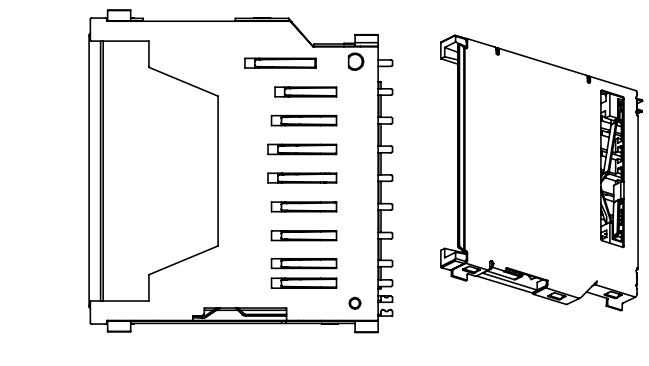
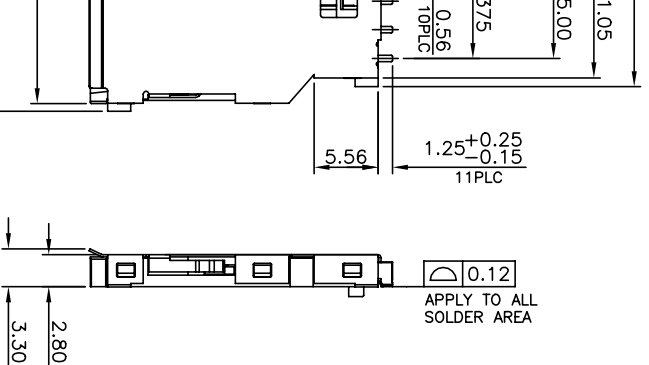

CIRCUIT:

WRITE PROTECT INDICATION	CARD DETECT INDICATION	WRITE PROTECT INDICATION	CARD DETECT INDICATION	WRITE PROTECT INDICATION	CARD DETECT INDICATION
WITHOUT CARD	GROUND	CARD INSERTED	GROUND	CARD INSERTED	GROUND
		WRITE PROTECT:LOCK		WRITE PROTECT:UNLOCK	

FINISH	PACKAGE	PART NUMBER
	REEL	2041021-4
	TRAY	2041021-3
	REEL	2041021-2
	TRAY	2041021-1

94 V-0, COLOR: NATURAL.
=0.15mm

ON CONTACT AREA.
PLATED ON SOLDER TAILS.
PLATED OVERALL.

PLATED OVERALL.

ON CONTACT AREA.
PLATED ON SOLDER TAILS.
PLATED OVERALL.

PLATED OVERALL.

ION B.

THIS DRAWING IS A CONTROLLED DOCUMENT.

DMN	B	MCMASTER	25FEB2008
CHK	D	GORENC	25FEB2008

DMN	B	MCMASTER	25FEB2008
CHK	D	GORENC	25FEB2008



TE Connectivity

DIMENSIONS:	TOLERANCES UNLESS OTHERWISE SPECIFIED:
mm	±
0 PLG	±0.3
1 PLG	±0.2
2 PLG	±0.15
3 PLG	±
4 PLG	±.3
ANGLES	

APVD	D	GORENC	25FEB2008
PRODUCT SPEC			
APPLICATION SPEC			

NAME	SECURE DIGITAL CARD CONNECTOR
TOP MOUNT, SMT TYPE, H=2.80mm	

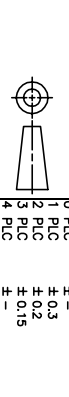

WEIGHT	1.73 GRAMS
--------	------------

SIZE	A3
CAGE CODE	00779
DRAWING NO	2041021
RESTRICTED 3D	

SEE NOTE

SEE NOTE

CUSTOMER DRAWING	
SCALE	
SHEET	1 of 3
REV	C

A

B

C

D

LOC	DIST	REVISONS		DATE	DMN	APVD
DW		P	L/R	DESCRIPTION		
				SEE SHEET 1.		

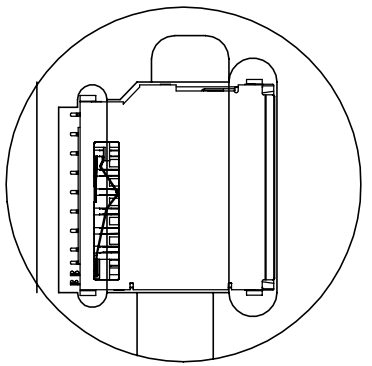

DETAIL A
SCALE 4:1
PART ORIENTATION
SHOWN FOR REFERENCE

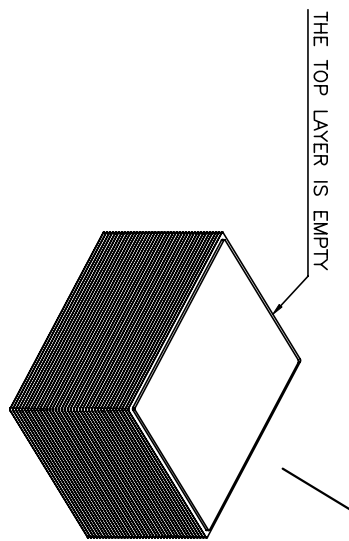
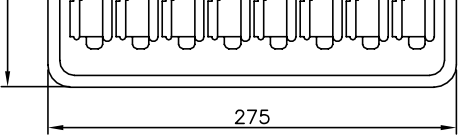

THE TOP LAYER IS EMPTY

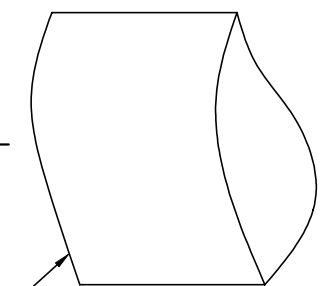

BAG

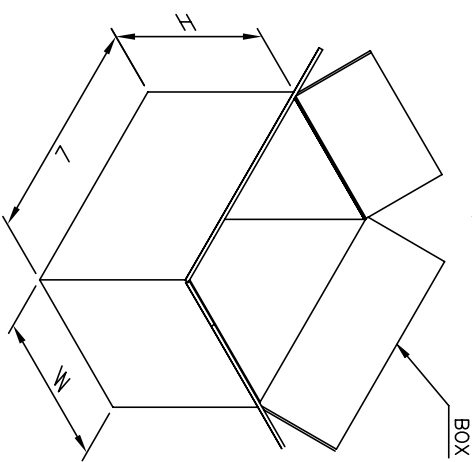

BOX

4.6 KG	2.08 KG	48	25	1200	2041021-3
GROSS WEIGHT	NET WEIGHT	PCS/ TRAY	TRAY/ BOX	PCS/ BOX	2041021-1
					PART NUMBER

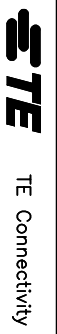

SECURE DIGITAL CARD CONNECTOR
TOP MOUNT, SMT TYPE, H=2.80mm

THIS DRAWING IS A CONTROLLED DOCUMENT.		DMN	CHK	APVD	NAME	RESTRICTED 3D
DIMENSIONS: mm		TOLERANCES UNLESS OTHERWISE SPECIFIED:		PRODUCT SPEC	APPLICATION SPEC	WEIGHT
		0 P/C	±	±0.3		
		1 P/C	±	±0.3		
		2 P/C	±	±0.15		
		3 P/C	±	±0.15		
		4 P/C	±	±0.15		
		5 P/C	±	±0.15		
FINISH		ANGLES		APPLIC		
MATERIAL		FINISH		WEIGHT		

10mm
THICKNESS=0.1mm
95mm

CUSTOMER DRAWING

A3	00779	2041021	SCALE	SHEET	REV
				2 of 3	C

A

B

C

D

2

1

REVOLUTION		3		2		1	
LOC	DIST	P	LTR	DESCRIPTION	DATE	DMN	APVD
DW				SEE SHEET 1.			

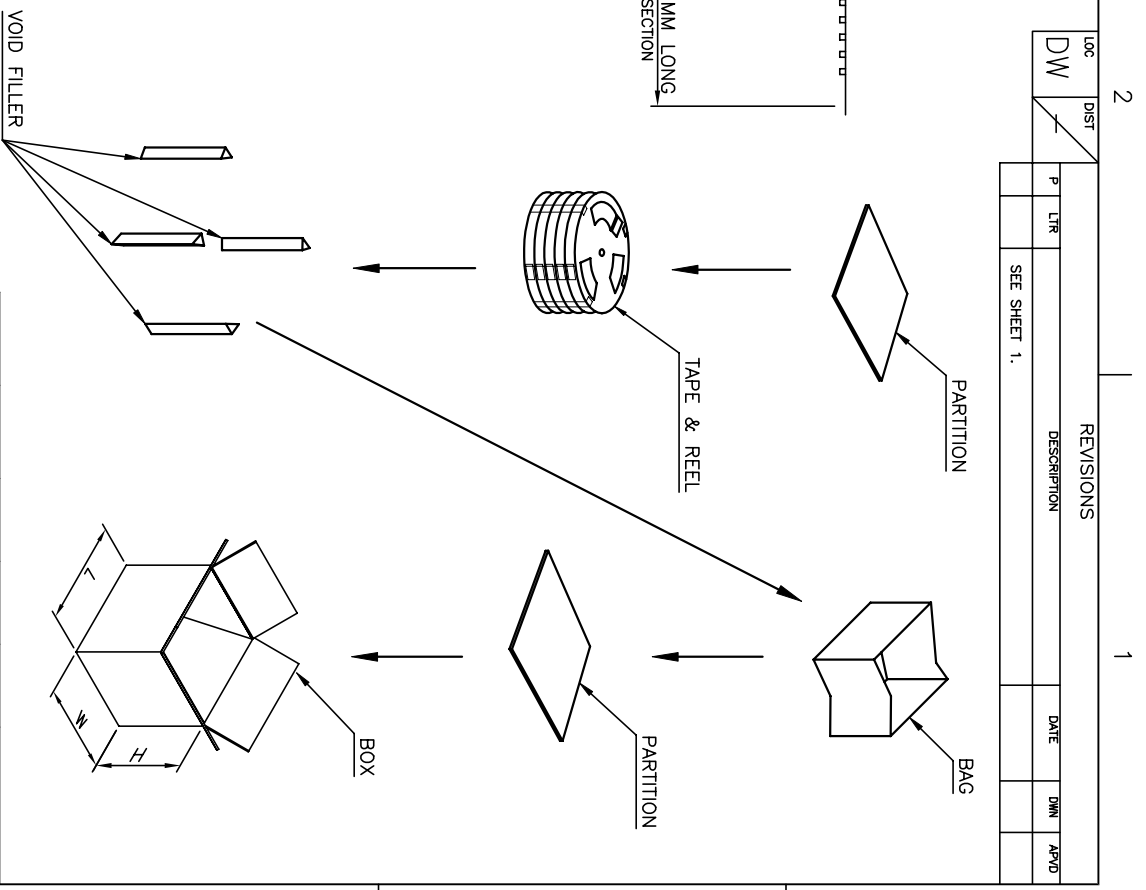
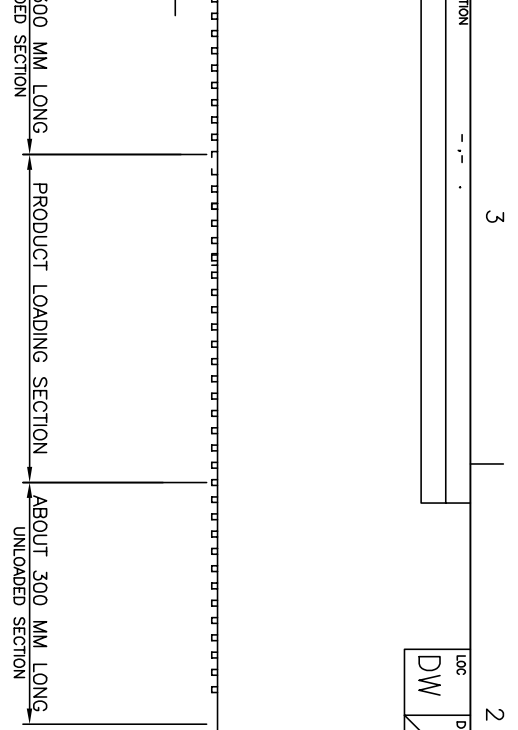

8.8 KG	4.15 KG	300	8	2400	2041021-4
GROSS WEIGHT	NET WEIGHT	PCS/ REEL	REEL/ BOX	PCS/ BOX	PART NUMBER



TE Connectivity

SECURE DIGITAL CARD CONNECTOR
TOP MOUNT, SMT TYPE, H=2.80mm

THIS DRAWING IS A CONTROLLED DOCUMENT.		DMN	CHK	APVD	NAME	RESTRICTED 3D
DIMENSIONS: mm		TOLERANCES UNLESS OTHERWISE SPECIFIED:		PRODUCT SPEC	SIZE	
		0 P/C	±	APVD	A3	
		1 P/C	±0.3	PRODUCT SPEC	CAGE CODE	
		2 P/C	±0.2	APPLICATION SPEC	2041021	
		3 P/C	±0.15	WEIGHT	DRAWING NO	
		4 P/C	±	CUSTOMER DRAWING	2041021	
		ANGLES	± 3'		SCALE	
					SHEET	3 of 3
					REV	C

SSS=0.1mm

A



B

C

D

Looking for pricing, stock, or lifecycle information?

Click below to explore more details on WIN SOURCE:

-  [View RC0402FR-0754K9L on WIN SOURCE](#)
-  [Yageo Information](#)

Optimize Your Supply Chain with WIN SOURCE Solutions

-  Global Sourcing Solution
-  Obsolete Management
-  Cost Control Management
-  Shortage Management
-  Alternative Solution
-  Excess Inventory Management