

## 3 mm Square Low-Profile SMT Trimmer Potentiometers (Cermet, Open Frame Type)



Type: **EVM3W**

### Features

- Low-profile 0.95 mm (1.1 mm max.)
- High reliability realized by cermet element
- Excellent mountability
- Conforms to JIS C5260-1:1999
- RoHS compliant

### Recommended Applications

- Audio/visual, office, and communication equipment
- General electronic equipment

### Explanation of Part Numbers

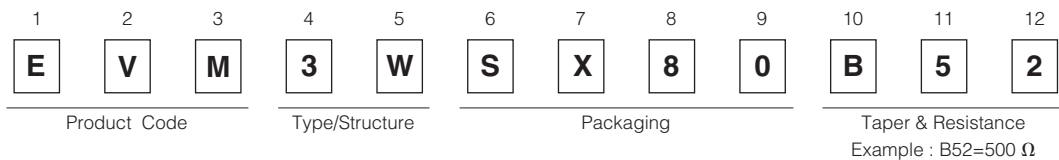

### Specifications

Total Resistance Value	100 Ω to 1 MΩ
Resistance Tolerance	±25 %
Power Rating	0.15 W
Limiting Element Voltage	50 V
Rotation Torque	2 to 20 mN·m
Temperature Coefficient of Resistance	±250 × 10 <sup>-6</sup> /°C

### Minimum Quantity/Packing Unit

Part Number	Taping		
	Quantity per reel	Packaging quantity	Dia. of reel (mm)
EVM3W	3,000	15,000	φ178

The standard packaging methods for a reel is φ178.

Please contact us, if you would like different packaging methods. (Bulk, Reel of φ330, Reel of φ380)

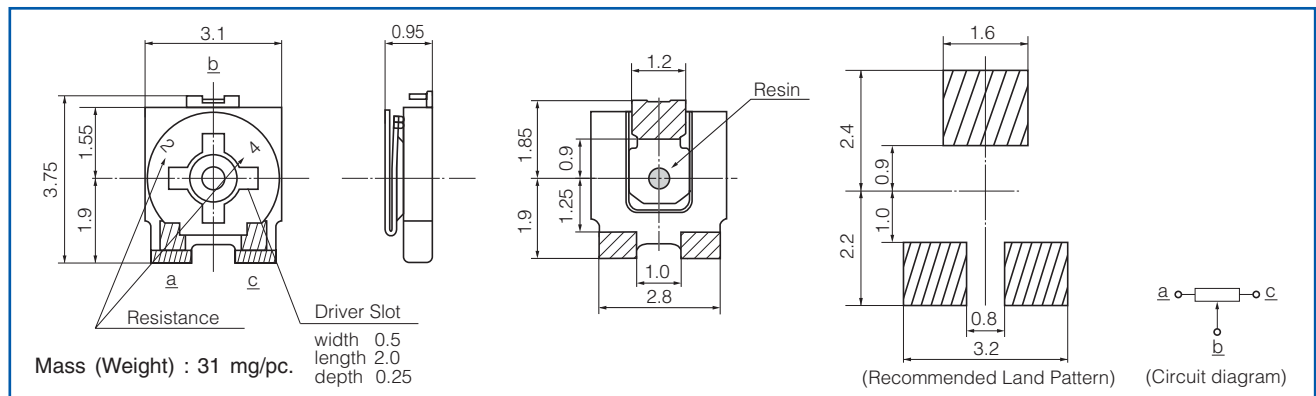

### Dimensions in mm (not to scale)

- 3-terminal/Low-profile





## Looking for pricing, stock, or lifecycle information?

Click below to explore more details on WIN SOURCE:

-  [View EVM3WSX80BE4 on WIN SOURCE](#)
-  [Panasonic Information](#)

## Optimize Your Supply Chain with WIN SOURCE Solutions

-  Global Sourcing Solution
-  Obsolete Management
-  Cost Control Management
-  Shortage Management
-  Alternative Solution
-  Excess Inventory Management